

Catálogo profesional

Hotali@GROUP



ALG

Hostelería profesional desde 1994



Álvarez Gómez
SUMINISTROS DE HOSTELERÍA

Pol. Ind. Ombatillo, c/C s/n, 31591- Corella (Navarra)
Tel. 948 780 859 · Fax. 948 401 074
www.alvarez-gomez.com



Estimados clientes,

Tenemos el placer de presentarles nuestro nuevo catálogo de productos para el sector profesional del canal HORECA, donde encontrará más de 10.000 productos que han sido seleccionados para satisfacer la demanda de todos los profesionales del sector.

Cooperamos con las marcas más prestigiosas y de renombre del sector, esto nos permite poder ofrecer a todos nuestros clientes una selección de productos de alta calidad y valor añadido que aportarán una diferencia mayor a su negocio.

Nuestra gama de artículos con marca propia han sido seleccionados y fabricados en cooperación con los mejores fabricantes del sector, para poder ofrecer a nuestros clientes la mejor relación-calidad-precio del mercado.

La unión y fuerza de un gran grupo como es Hoteralia trabaja para aportar soluciones a todos nuestros clientes en el día a día, mediante la distribución nacional e internacional del sector de equipamientos y servicios de hostelería.

Contamos con más de 100 años de experiencia en el sector, como así lo demuestran algunas empresas que forman parte de este grupo.

Nuestros valores son: **compromiso de servicio y atención personalizada a clientes.**

Disponemos de unas infraestructuras compuestas por 44 almacenes, con una capacidad de almacenamiento de más de 36.895 m². Realizamos más de 20.000 entregas mensuales a nuestros clientes finales, con nuestra flota de 150 vehículos. Nuestro grupo está formado por un gran equipo humano de 280 personas en plantilla, quienes prestan la mejor atención a nuestros más de 37.600 clientes nacionales.

* Hoteralia se reserva el derecho a cambiar o sustituir los productos que aparecen en este catálogo y que puedan haber sufrido cambios por el fabricante sin previo aviso.

ÍNDICE

● Vajilla.....	003
● Cristalería.....	057
● Cubertería.....	113
● Cuchillería.....	139
● Cocina.....	155
● Cafetería y servicios de mesa.....	193
● Almacenaje.....	215
● Buffet y catering.....	235
● Maquinaria.....	279
● Textil y vestuario.....	303
● Consumibles	313



VAJILLA

Crockery • Vaiselle • Vasellame • Geschirr



Bone Fine China



La porcelana Bone Fine China, también conocida como Bone China, es una porcelana de ceniza de hueso compuesta por un tipo de pasta de porcelana fosfática, además de caolín, feldespato y cuarzo, que contiene un mínimo del 30% de ceniza de hueso utilizada para la fusión de los diferentes materiales que la componen.



Caracterizada por un alto grado de blancura y transparencia, su dureza y alta resistencia a los golpes, hacen de esta porcelana una de las más nobles y mejores porcelanas del mundo.



95973 (Gold)-BD5220
Plato presentación
30 cm.



50180-5312
Plato presentación 30 cm.



50180-5220
Plato pasta 30 cm.



50180-5242
Plato llano 27 cm.



50180-5243
Plato llano 23 cm.



50180-5244
Plato postre 21 cm.



50180-5245
Plato pan 18 cm.

Sprit



50180-5304
Plato hondo 23 cm.



50180-5219
Plato pasta 27 cm.



50180-3452
Plato pasta 23 cm.



Fuentes



50180-5314
38 cm.



50180-3449
43 cm.

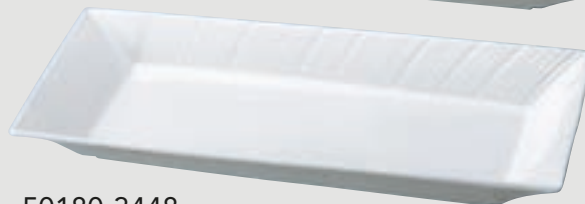

50180-3448
28 cm.

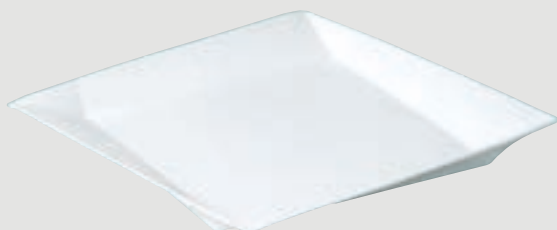

50180-3430
Plato cuadrado 33 cm.



50180-3450
Plato llano 28 cm.

50827-5371
60x26 cm.



50827-5372
60x20 cm.

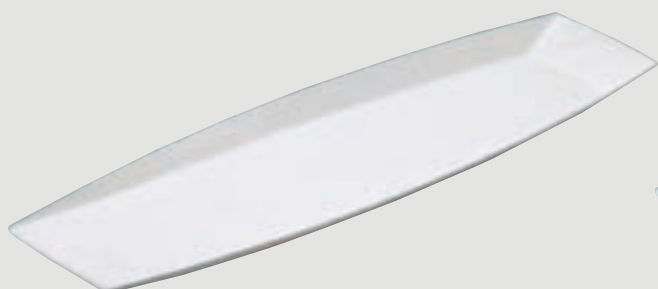

50827-5383
40 cm.

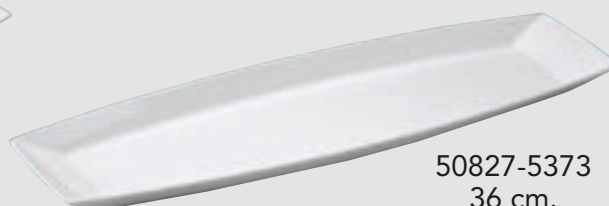

50827-5373
36 cm.

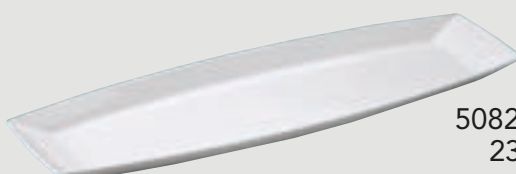

50827-9743
23 cm.

Oval



50617-5301
Plato 30 cm.



50617-5300
Plato lágrima llano 28 cm.



50617-5302
Plato 17 cm.



50617-5298
Plato lágrima hondo 28 cm.

Presentación



95973 (Gold)-BD5220
Plato presentación 30 cm.



50730-5270
Plato cuadrado 27 cm.



50180-887
Plato palette 40 cm.



51091-5509
Fuente rectangular
42 cm.



51091-5507
Plato cuadrado 30 cm.

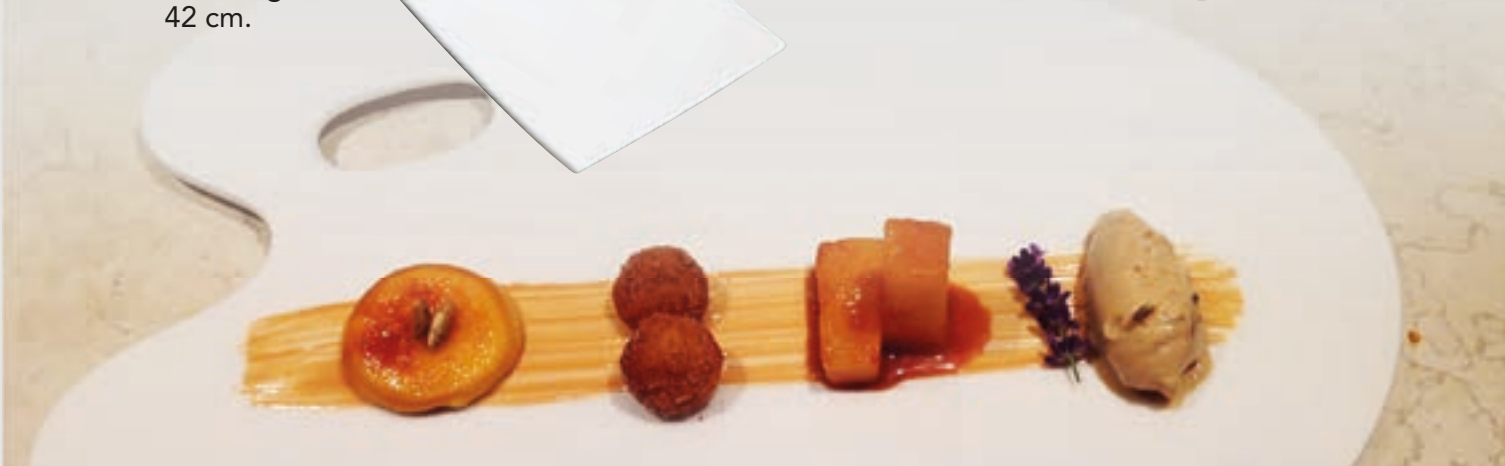

Resistencia

La porcelana vitrificada tiene un alto contenido de alúmina lo que confiere una extrema dureza y resistencia al desportillamiento.

Durabilidad

La especial fórmula de nuestro esmalte lo hace adecuado para el uso extremo en restauración por su gran resistencia al golpeo, la abrasión y los detergentes.

Microondas

Los productos vitrificados Continental pueden ser utilizados de forma segura en hornos microondas ya que no contienen metales preciosos en su esmalte o decoración.

Higiene

La porcelana vitrificada Continental es impermeable al agua. La esmaltación de la base de las diferentes piezas evita la absorción de agua y otros materiales.

Customización

Ofrecemos la posibilidad de personalizar el producto con su logo y otros destacados.

Calidad

Continental utiliza los principios ISO-9002 para asegurar la consistencia del producto a través de estándares desarrollados a lo largo de muchos años de liderazgo en el sector.



Polaris



Continental

Plato llano



Referencia	Medidas	Cantidad
55CPWD196	31 cm Ø	12
55CPWD102	29 cm Ø	12
55CPWD101	27 cm Ø	24
55CPWD001	25 cm Ø	24
55CPWD302	23 cm Ø	24
55CPWD009	20 cm Ø	24
55CPWD004	17 cm Ø	24

Fuente oval



Referencia	Medidas	Cantidad
55CPWD073	38 cm	12
55CPWD076	30 cm	12
55CPWD075	28 cm	12
55CPWD125	25 cm	24
55CPWD074	23 cm	24
55CPWD122	20 cm	24

Plato ondo/pasta



Referencia	Medidas	Cantidad
55CPWD103	28 cm Ø	12
55CPWD104	26 cm Ø	12
55CPWD005	23 cm Ø	24

Fuente rectangular



Referencia	Medidas	Cantidad
50CCPWD079	30 cm	12
50CCPWD078	35 cm	12

Plato pizza



Referencia	Medidas	Cantidad
50CCPWD195	31,5 cm Ø	12
50CCPWD194	26,5 cm Ø	12

Fuente oval ala ancha



Referencia	Medidas	Cantidad
55CCPWD078	35 cm	12
55CCPWD078	32 cm	12



Continental



Plato cuadrado

Referencia	Medidas	Cantidad
20CCEVW139	28 cm	12
20CCEVW151	23 cm	12
20CCEVW870	18 cm	24



Plato triangular

Referencia	Medidas	Cantidad
20CCEVW206	26 cm	12
20CCEVW140	19 cm	24



Plato sushi

Referencia	Medidas	Cantidad
50CCEVW142	27 cm	12



Ensaladera Square

Referencia	Medidas	Cantidad
20CCEVW162	24 cm	12
20CCEVW161	21 cm	12
20CCEVW160	18 cm	12



Bol arroz

Referencia	Medidas	Cantidad
20CCEVW132	15,5 cm Ø	12
20CCEVW133	13,5 cm Ø	12
20CCEVW131	12,5 cm Ø	12
20CCEVW200	10,5 cm Ø	12



Bols

Referencia	Medidas	Cantidad
20CCEVW134	15 cm Ø	12
20CCEVW135	15 cm Ø	24



Plato 4 departamentos

Referencia	Medidas	Cantidad
20CCEVW138	17 cm	12



Plato 3 departamentos

Referencia	Medidas	Cantidad
20CCEVW137	14 cm	12

Ensaladeras

Ensaladera Polaris

Referencia	Medidas	Cantidad
50CCPWD126	26 cm Ø	4
50CCPWD118	18 cm Ø	12
50CCPWD114	14 cm Ø	24

Ensaladera Fusión Salsa

Referencia	Medidas	Cantidad
29CCFUS174	22 cm	12
29CCFUS173	18 cm	12
29CCFUS172	14 cm	24
29CCFUS171	10 cm	24

Ensaladera Fusión Soy

Referencia	Medidas	Cantidad
29CCFUS184	22 cm Ø	12
29CCFUS183	18 cm Ø	12
29CCFUS182	14 cm Ø	24
29CCFUS181	10 cm Ø	24

Bol Salsa

Referencia	Capacidad	Cantidad
50CCPWD047	23 cl	12
50CCPWD048	15 cl	12
50CCPWD046	7,5 cl	24



Tacerío

Continental



Taza Polaris

Referencia	Capacidad	Cantidad
51CCPWD035	20 cl	24
51CCPWD031	18 cl	24
51CCPW0036	10 cl	24



Taza Capuccino

Referencia	Capacidad	Cantidad
51CCPWD030	30 cl	24
51CCPWD038	23 cl	24
51CCPWD034	7,5 cl	24



Taza Montblanc

Referencia	Capacidad	Cantidad
66CCMOB037	20 cl	24
66CCMOB031	18 cl	24
66CCMOB036	10 cl	24



Taza Everest

Referencia	Capacidad	Cantidad
66CCMOB037	20 cl	24
66CCMOB031	18 cl	24
66CCMOB036	10 cl	24



Platillo Polaris

Referencia	Medidas	Cantidad
51CCPWD007	15 cm	24
51CCPWD033	12 cm	24



Platillo Capuccino

Referencia	Medidas	Cantidad
51CCPWD007	15 cm	24
51CCPWD033	12 cm	24



Platillo Montblanc

Referencia	Medidas	Cantidad
66CCMOB037	15 cm	24
66CCMOB008	12 cm	24



Platillo Everest

Referencia	Medidas	Cantidad
21CCEVE307	15 cm	24
21CCEVE008	12 cm	24

Everest

Plato llano

Referencia	Medidas	Cantidad
21CCEVE196	31 cm Ø	12
21CCEVE102	29 cm Ø	12
21CCEVE101	27 cm Ø	24
21CCEVE001	25 cm Ø	24
21CCEVE302	23 cm Ø	24
21CCEVE009	20 cm Ø	24
21CCEVE004	17 cm Ø	24



Plato hondo/pasta

Referencia	Medidas	Cantidad
21CCEVE103	28 cm Ø	12
21CCEVE104	26 cm Ø	12
21CCEVE005	23 cm Ø	24



Continental

Mont Blanc

Plato llano

Referencia	Medidas	Cantidad
66CCMOB196	31 cm Ø	12
66CCMOB102	29 cm Ø	12
66CCMOB101	27 cm Ø	24
66CCMOB001	25 cm Ø	24
66CCMOB302	23 cm Ø	24
66CCMOB009	20 cm Ø	24
66CCMOB004	17 cm Ø	24



Plato hondo/pasta

Referencia	Medidas	Cantidad
66CCMOB103	28 cm Ø	12
66CCMOB104	26 cm Ø	12
66CCMOB005	23 cm Ø	24



Fuente oval ala ancha

Referencia	Medidas	Cantidad
66CCMOB079	30 cm	12



Bistro



Fuente recta

Referencia	Medidas	Cantidad
33RECT203	33x20 cm	12
33RECT202	28x16 cm	12
33RECT201	26x16 cm	12
33RECT204	36x16 cm	12
33RECT205	26x26 cm	12



Fuente curva

Referencia	Medidas	Cantidad
32CURV193	35x20 cm	12
32CURV192	36x15 cm	12
32CURV194	28x16 cm	12
32CURV191	36x10 cm	12

Continental

Pebble



Plato llano

Referencia	Medidas	Cantidad
30PEB231	31x28 cm	12
30PEB233	25x21 cm	12
30PEB234	20x18 cm	12



Plato hondo

Referencia	Medidas	Cantidad
30PEB232	27x24 cm	12



White-01



Light Green-02

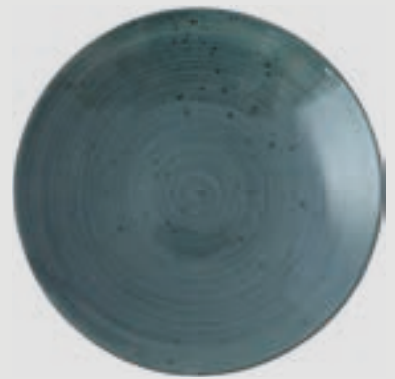

Blue-03



Terracota-04



Dark Green-05

Rustics White



Continental



Plato llano Coupe

Referencia	Medidas	Cantidad
29FUS335-01	29 cm Ø	12
29FUS334-01	27 cm Ø	12
29FUS332-01	23 cm Ø	12
29FUS331-01	19 cm Ø	12



Plato hondo Coupe

Referencia	Medidas	Cantidad
29FUS343-01	29 cm Ø	12
29FUS342-01	24,5 cm Ø	12
29FUS341-01	20 cm Ø	12



Plato Pebble llano

Referencia	Medidas	Cantidad
30PEB231-01	31x28 cm	12
30PEB233-01	25x21 cm	12
30PEB234-01	20x18 cm	12



Plato hondo

Referencia	Medidas	Cantidad
30PEB232-01	27x24 cm	12

Ensaladera Fusión Salsa



Referencia	Medidas	Cantidad
29CCFUS174-01	22 cm	12
29CCFUS173-01	18 cm	12
29CCFUS172-01	14 cm	24
29CCFUS171-01	10 cm	24



Bol

Referencia	Medidas	Cantidad
20RUS047-01	12,5 cm	12



Fuente recta

Referencia	Medidas	Cantidad
33RECT204-01	36x16 cm	12
33RECT203-01	33x20 cm	12
33RECT202-01	28x16 cm	12
33SQU205-01	26x26 cm	12



Fuente curva

Referencia	Medidas	Cantidad
33CURV193-01	36x20 cm	12
33CURV192-01	36x15 cm	12
33CURV191-01	36x10 cm	12



Taza Capuccino

Referencia	Capacidad	Cantidad
51RUS030-01	30 cl	24
51RUS038-01	23 cl	24
51RUS034-01	7,5 cl	24



Plato llano Coupe

Referencia	Medidas	Cantidad
29FUS335-04	29 cm Ø	12
29FUS334-04	27 cm Ø	12
29FUS332-04	23 cm Ø	12
29FUS331-04	19 cm Ø	12



Plato hondo Coupe

Referencia	Medidas	Cantidad
29FUS343-04	29 cm Ø	12
29FUS342-04	24,5 cm Ø	12
29FUS341-04	20 cm Ø	12



Plato Pebble llano

Referencia	Medidas	Cantidad
30PEB231-04	31x28 cm	12
30PEB233-04	25x21 cm	12
30PEB234-04	20x18 cm	12



Plato hondo

Referencia	Medidas	Cantidad
30PEB232-04	27x24 cm	12



Ensaladera Fusión Salsa

Referencia	Medidas	Cantidad
29CCFUS174-04	22 cm	12
29CCFUS173-04	18 cm	12
29CCFUS172-04	14 cm	24
29CCFUS171-04	10 cm	24



Bol

Referencia	Medidas	Cantidad
20RUS047-04	12,5 cm	12



Fuente recta

Referencia	Medidas	Cantidad
33RECT204-04	36x16 cm	12
33RECT203-04	33x20 cm	12
33RECT202-04	28x16 cm	12
33SQU205-04	26x26 cm	12



Fuente curva

Referencia	Medidas	Cantidad
33CURV193-04	36x20 cm	12
33CURV192-04	36x15 cm	12
33CURV191-04	36x10 cm	12



Taza Capuccino

Referencia	Capacidad	Cantidad
51RUS030-04	30 cl	24
51RUS038-04	23 cl	24
51RUS034-04	7,5 cl	24





Reactivos



Lava-21



Turquoise-22



Purple-24



Red-41



Yellow-42



Lime-43



Orange-44

Plato llano Coupe

Referencia	Medidas	Cantidad	
29FUS331	19 cm Ø	24	21-22-41-42
29FUS332	23 cm Ø	24	21-22-41
29FUS334	27 cm Ø	24	21-22-24-41-42
29FUS335	29 cm Ø	12	21-22-24-41-42-43-44

Plato hondo Coupe

Referencia	Medidas	Cantidad	
29FUS342	24,5 cm Ø	24	21-22-41-42-44
29FUS343	29 cm Ø	12	21-22-41-42-44



Plato Pebble llano

Referencia	Medidas	Cantidad	
30PEB231	31x28 cm Ø	12	22-41
30PEB233	25x21 cm Ø	24	22-41
30PEB234	20x18 cm Ø	24	22-41



Fuente recta

Referencia	Medidas	Cantidad	
33RECT201	26x16 cm Ø	12	21-22-24-41-42-43
33RECT204	36x16 cm Ø	12	21-22-41-42-43

Fuente curva

Referencia	Medidas	Cantidad	
32CURV191	36x9,5 cm Ø	12	22-41
32CURV192	36x15 cm Ø	12	21-22-41-42-43
32CURV193	35x19 cm Ø	12	41-42-43

Continental



Bol salsa

Referencia	Medidas	Cantidad	
29FUS171	10 cm	24	21-22-41-42-43
29FUS172	14 cm	24	21-22-41-42-43
29FUS174	22 cm	12	21-22-41-42

Venus



Plato llano

Referencia	Medidas	Cantidad
V015DU00	15 cm Ø	12
V018DU00	18 cm Ø	12
V020DU00	20 cm Ø	12
V024DU00	24 cm Ø	12
V026DU00	26 cm Ø	12
V028DU00	28 cm Ø	6
V032DU00	32 cm Ø	6



Bol apilable

Referencia	Medidas	Capacidad	Cantidad
E006JK00	6 cm Ø	4 cl	24
E008JK00	8 cm Ø	9 cl	24
E010JK00	10 cm Ø	18 cl	24
E012JK00	12 cm Ø	38 cl	12
E014JK00	14 cm Ø	66 cl	12
E016JK00	16 cm Ø	98 cl	6



Plato hondo

Referencia	Medidas	Cantidad
V022CK00	22 cm Ø	12



Bol

Referencia	Medidas	Cantidad
ED15KK00	15 cm Ø	12
ED19KK00	19 cm Ø	12
ED25KK00	25 cm Ø	6



Fuente oval

Referencia	Medidas	Cantidad
V021KY00	21x15 cm	6
V025KY00	25x18 cm	6
V028KY00	28x20 cm	6
V032KY00	32x23 cm	6
V035KY00	35x25 cm	6
V039KY00	39x28 cm	6



Taza c/plato

Referencia	Capacidad	Cantidad
V002KT00	9 cl	12
V0023C00	17 cl	12
V002CT00	23 cl	12



Plato llano

Referencia	Medidas	Cantidad
D116DU00	16 cm Ø	12
D117DU00	17 cm Ø	12
D118DU00	18 cm Ø	12
D120DU00	20 cm Ø	12
D122DU00	22 cm Ø	12
D124DU00	24 cm Ø	12
D126DU00	26 cm Ø	12
D127DU00	27 cm Ø	12
D128DU00	28 cm Ø	6
D130DU00	30 cm Ø	6
D132DU00	32 cm Ø	6

Plato hondo

Referencia	Medidas	Cantidad
D122CK00	22 cm Ø	12
D123CK00	23 cm Ø	12

Fuente oval

Referencia	Medidas	Cantidad
DD21KY00	21x14 cm	6
DD25KY00	24x17 cm	6
DD29KY00	29x20 cm	6
DD34KY00	34x24 cm	6
DD39KY00	39x27 cm	6

Bol apilable

Referencia	Medidas	Capacidad	Cantidad
E006JK00	6 cm Ø	4 cl	24
E008JK00	8 cm Ø	9 cl	24
E010JK00	10 cm Ø	18 cl	24
E012JK00	12 cm Ø	38 cl	12
E014JK00	14 cm Ø	66 cl	12
E016JK00	16 cm Ø	98 cl	6

Bol

Referencia	Medidas	Cantidad
E014KK00	14 cm Ø	12
E019KK00	19 cm Ø	12
GR23KK00	23 cm Ø	6

Taza c/plato

Referencia	Capacidad	Cantidad
E002KT00	6 cl	12
E002EK00	9 cl	12
E002NT00	14 cl	12
E0023C00	17 cl	12
E002CT00	23 cl	12



Plato llano

Referencia	Medidas	Cantidad
EO15DU00	15 cm Ø	12
EO17DU00	17 cm Ø	12
EO19DU00	19 cm Ø	12
EO21DU00	21 cm Ø	12
EO23DU00	23 cm Ø	12
EO25DU00	25 cm Ø	12
EO27DU00	27 cm Ø	12
EO28DU00	28 cm Ø	6
EO30DU00	30 cm Ø	6

Plato hondo

Referencia	Medidas	Cantidad
EO20CK00	20 cm Ø	12

Fuente oval

Referencia	Medidas	Cantidad
EO15KY00	15x9 cm	12
EO19KY00	19x11 cm	6
EO24KY00	24x14 cm	6
EO26KY00	26x15 cm	6
EO29KY00	29x17 cm	6
EO34KY00	34x20 cm	6
EO39KY00	39x24 cm	6

Bol

Referencia	Medidas	Cantidad
EO14KK00	14 cm Ø	12
EO19KK00	19 cm Ø	12
GR23KK00	23 cm Ø	6

Bol apilable

Referencia	Medidas	Capacidad	Cantidad
E006JK00	6 cm Ø	4 cl	24
E008JK00	8 cm Ø	9 cl	24
E010JK00	10 cm Ø	18 cl	24
E012JK00	12 cm Ø	38 cl	12
E014JK00	14 cm Ø	66 cl	12
E016JK00	16 cm Ø	98 cl	6

Taza c/plato

Referencia	Capacidad	Cantidad
E002KT00	6 cl	12
E002EK00	9 cl	12
E002NT00	14 cl	12
E0023C00	17 cl	12
E002CT00	23 cl	12



Plato llano

Referencia	Medidas	Cantidad
MMZ18DU00	16x16 cm	12
MMZ21DU00	18x18 cm	12
MMZ25DU00	22x22 cm	12
MMZ27DU00	23x23 cm	12
MMZ29DU00	25x25 cm	12
MMZ32DU00	28x28 cm	6
MMZ35DU00	30x30 cm	6



Plato hondo

Referencia	Medidas	Cantidad
MMZ21CK00	18x18 cm	12
MMZ22CK00	19x19 cm	12

Fuente oval

Referencia	Medidas	Cantidad
MMZ19KY00	19x13 cm	6
MMZ24KY00	24x16 cm	6
MMZ29KY00	29x19 cm	6
MMZ34KY00	34x23 cm	6
MMZ39KY00	39x26 cm	6



Bol

Referencia	Medidas	Cantidad
MMZ16KK00	14x14 cm	12
MMZ19KK00	17x17 cm	12
MMZ25KK00	21x21 cm	6



Bol apilable

Referencia	Medidas	Capacidad	Cantidad
MRS06JK00	6 cm Ø	4 cl	12
MRS10JK00	10 cm Ø	20 cl	12
MRS12JK00	12 cm Ø	35 cl	12



Taza c/plato

Referencia	Capacidad	Cantidad
MMZ02KT00	7 cl	12
MMZ02EK00	9 cl	12
MMZ023C00	17 cl	12
MMZ02CT00	23 cl	12



Estambul



Plato llano

Referencia	Medidas	Cantidad
XT14DU00	14 cm Ø	12
XT17DU00	17 cm Ø	12
XT19DU00	19 cm Ø	12
XT21DU00	21 cm Ø	12
XT23DU00	23 cm Ø	12
XT25DU00	25 cm Ø	12
XT27DU00	27 cm Ø	12
XT30DU00	30 cm Ø	6
XT32DU00	32 cm Ø	6

Bol

Referencia	Medidas	Cantidad
XT15KK00	15 cm Ø	12
XT19KK00	19 cm Ø	12
XT25KK00	25 cm Ø	6

Bol apilable

Referencia	Medidas	Capacidad	Cantidad
XT06JK00	6 cm Ø	4 cl	24
XT08JK00	8 cm Ø	9 cl	24
XT10JK00	10 cm Ø	18 cl	24
XT12JK00	12 cm Ø	38 cl	12

Plato hondo

Referencia	Medidas	Cantidad
XT22CK00	22 cm Ø	12

Fuente oval

Referencia	Medidas	Cantidad
XT20KY00	20x16 cm	6
XT24KY00	24x19 cm	6
XT29KY00	29x23 cm	6
XT34KY00	34x27 cm	6
XT39KY00	39x31 cm	6

Taza c/plato

Referencia	Capacidad	Cantidad
XT02KT00	9 cl	12
XT02NT00	14 cl	12
XT023C00	17 cl	12
XT02CT00	23 cl	12

GÜRÜL PORSELEN
"Dünyanın Porseleni"



Plato llano gourmet

Referencia	Medidas	Cantidad
------------	---------	----------

MDR29GDU00	29 cm Ø	6
MDR31GDU00	32 cm Ø	6



Platos Especiales



Delta plato pasta

Referencia	Medidas	Cantidad
------------	---------	----------

D127CK00	27 cm Ø	6
D130CK00	30 cm Ø	6



Reno plato pasta

Referencia	Medidas	Cantidad
------------	---------	----------

RN26CK00	26 cm Ø	6
RN30CK00	30 cm Ø	6



Estambul plato pasta

Referencia	Medidas	Cantidad
------------	---------	----------

XT30CK00	30 cm Ø	6
----------	---------	---



Plato pizza

Referencia	Medidas	Cantidad
------------	---------	----------

D128PT00	28 cm Ø	6
D130PT00	30 cm Ø	6
D133PT00	33 cm Ø	6

GÜRAL PORSELEN
"Dünyanın Porseleni"



Plato Steak

Referencia	Medidas	Cantidad
------------	---------	----------

D129IZ00	29 cm Ø	6
----------	---------	---

Colorado-Rojo

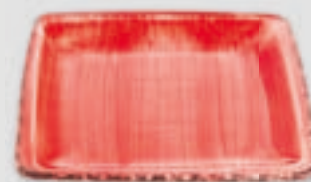

Plato llano

Referencia	Medidas	Cantidad
NBNKL17X17DU	17x17 cm	12
NBNKL19X19DU	19x19 cm	12
NBNKL22X22DU	22x22 cm	12
NBNKL25X25DU	17x17 cm	12



Plato hondo

Referencia	Medidas	Cantidad
NBNKL25X25CK	19x19 cm	12



Fuente rectangular

Referencia	Medidas	Cantidad
NBNKL24X14KY	24x14 cm	6
NBNKL29X17KY	24x14 cm	6



Bol

Referencia	Medidas	Cantidad
NBNKL15X15KK	15x15 cm	6
NBNKL15X15KK	17x17 cm	6



Bol apilable

Referencia	Medidas	Cantidad
NBNMRS06JK	6 cm Ø	24
NBNMRS10JK	10 cm Ø	24
NBNMRS12JK	12 cm Ø	12

GÜRAL PORSELEN
"Dünyanın Porseleni"



Taza c/plato

Referencia	Capacidad	Cantidad
NBKL90KFT	9 cl	12
NBKL170CKFT	17 cl	12
NBKL230CKFT	23 cl	12

Otros colores disponibles



Marrón



Natural



Antracita



Verde



Tierra



Turquesa



Plato llano

Referencia	Medidas	Cantidad
NBNEO15DU	15 cm Ø	12
NBNEO17DU	17 cm Ø	12
NBNEO19DU	19 cm Ø	12
NBNEO21DU	21 cm Ø	12
NBNEO23DU	23 cm Ø	12
NBNEO25DU	25 cm Ø	12
NBNEO27DU	27 cm Ø	12
NBNEO28DU	28 cm Ø	6
NBNEO30DU	30 cm Ø	6



Plato hondo

Referencia	Medidas	Cantidad
NBNEO20CK	20 cm Ø	12



Fuente rectangular

Referencia	Medidas	Cantidad
NBNEO15KY	15x9 cm	12
NBNEO19KY	19x11 cm	12
NBNEO24KY	24x14 cm	6
NBNEO26KY	26x15 cm	6
NBNEO29KY	29x17 cm	6
NBNEO34KY	34x20 cm	6
NBNEO39KY	34x24 cm	6



Bol

Referencia	Medidas	Cantidad
NBNEO14KK	14 cm Ø	12
NBNEO19KK	19 cm Ø	12
NBNEO23KK	23 cm Ø	6



Bol apilable

Referencia	Medidas	Cantidad
NBNEO06JK	6 cm Ø	24
NBNEO08JK	8 cm Ø	24
NBNEO10JK	10 cm Ø	24
NBNEO12JK	12 cm Ø	12
NBNEO14JK	14 cm Ø	6
NBNEO16JK	16 cm Ø	6
NBNEO22JK	22 cm Ø	6



Taza c/plato

Referencia	Capacidad	Cantidad
NBNEO02KT	6 cl	12
NBNEO02EKT	9 cl	12
NBNEO02NT	14 cl	12
NBNEO023C	17 cl	12
NBNEO02CT	23 cl	12

Otros colores disponibles

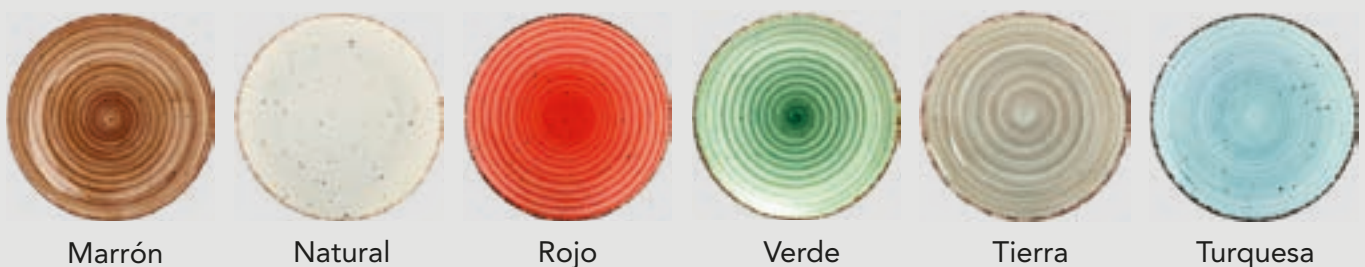

Marrón

Natural

Rojo

Verde

Tierra

Turquesa

Ming



Plato llano

Referencia	Medidas	Cantidad
B1536	41x41 cm	2
B1535	35x35 cm	4
B1277	31x31 cm	4
B1224	27x27 cm	4
B1157	24x24 cm	6
B1637	21x21 cm	6
B1156	19x19 cm	6
B2079	16x16 cm	6
B2078	12x12 cm	6
B2977	9x9 cm	12
B2076	7x7 cm	12



Plato hondo

Referencia	Medidas	Cantidad
B1225	20x20 cm	6

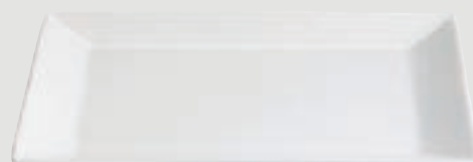

Plato rectangular

Referencia	Medidas	Cantidad
B2492	28x24 cm	6
B2393	24x20 cm	6
B2494	19x16 cm	6



Bol

Referencia	Medidas	Cantidad
B1424	16x16x16 cm	6
B1226	13x13x4,5 cm	6
B2499	10x10x6 cm	6
B1255	8x8x4 cm	6
B1425	6,5x6,5x3 cm	6



Bandeja estrecha

Referencia	Medidas	Cantidad
B2539	30x12 cm	6
B2599	28x16 cm	6
B1864	24x9 cm	6
B2540	23x12 cm	6
B2541	20x12 cm	6



Bandeja baguette

Referencia	Medidas	Cantidad
B2412	30x8 cm	6
B2413	25x8 cm	6
B2414	20x9 cm	6



Bol c/pie

Referencia	Medidas	Cantidad
B2103	11x11x3cm	6
B2104	7x7x2 cm	6



Ensaladera

Referencia	Medidas	Cantidad
B2561	25x25x11cm	3
B1275	20x20x9 cm	3



Fuente rectangular

Referencia	Medidas	Cantidad
B1623	46x28 cm	3
B1278	39x25 cm	4

Ming II - Stoneware



Plato llano

Referencia	Medidas	Cantidad
B2771	26x26 cm	6
B2977	24x24 cm	6
B2978	21x21 cm	6
B2772	18x18 cm	4
B758010	16x16 cm	6



Fuente rectangular

Referencia	Medidas	Cantidad
B2773	34x22 cm	1
B2883	30x20 cm	6
B2976	30x15 cm	6
B2774	25x15 cm	6
B758011	20x13 cm	6
B758012	30x8 cm	1



Fuente rectangular Boa

Referencia	Medidas	Cantidad
B2995	30x20 cm	6
B3300	30x15 cm	6
B3306	25x15 cm	6



Ensaladera

Referencia	Medidas	Cantidad
B2775	22x22x9cm	6
B758013	13x13x5 cm	6

Otros colores disponibles



Blanco



Crema



The Reserve Stoneware



Plato llano

Referencia	Medidas	Cantidad
BLANCO		
B2958	30 cm Ø	6
B2959	27 cm Ø	6
B2979	25 cm Ø	6
B2960	21 cm Ø	6
NEGRO		
B2964	30 cm Ø	6
B2965	27 cm Ø	6
B2980	25 cm Ø	6
B2966	21 cm Ø	6



Ensaladera

Referencia	Medidas	Cantidad
BLANCO		
B2962	24 cm Ø	6
B2963	17 cm Ø	6
NEGRO		
B2968	24 cm Ø	6
B2969	17 cm Ø	6



Plato hondo

Referencia	Medidas	Cantidad
BLANCO		
B2961	23 cm Ø	6
NEGRO		
B2967	23 cm Ø	6



Plato pasta

Referencia	Medidas	Cantidad
BLANCO		
B758027	29 cm Ø	6
NEGRO		
B758034	29 cm Ø	6



Plato pizza

Referencia	Medidas	Cantidad
BLANCO		
B758040	33 cm Ø	6
B758041	30 cm Ø	6
NEGRO		
B758042	33 cm Ø	6
B758043	30 cm Ø	6



Ipec-Muga Stoneware

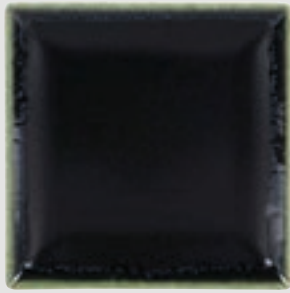

Plato llano Ming II

Referencia	Medidas	Cantidad
B758083	26x26 cm	6
B758084	24x24 cm	6
B758085	21x21 cm	6
B758086	18x18 cm	6
B758087	16x16 cm	12



Plato llano Infinity

Referencia	Medidas	Cantidad
B758095	32 cm Ø	6
B758096	26 cm Ø	6
B758097	20 cm Ø	12



Plato hondo Ming II

Referencia	Medidas	Cantidad
B758088	18x18 cm	6



Bol Infinity

Referencia	Medidas	Cantidad
B758099	16,5 cm Ø	12



Plato hondo Infinity

Referencia	Medidas	Cantidad
B758098	19,5 cm Ø	12



Bol Ming II

Referencia	Medidas	Cantidad
B758089	13x13 cm	12



Bandeja Rect Ming II

Referencia	Medidas	Cantidad
B758090	34x22 cm	1
B758091	30x20 cm	6
B758092	30x15 cm	6
B758093	25x15 cm	6
B758094	20x13 cm	12



Plato pizza The Reserve

Referencia	Medidas	Cantidad
B758100	30,5 cm Ø	6



Bol The Reserve

Referencia	Medidas	Cantidad
B758101	17,5 cm Ø	12



Colores disponibles



Kobe



Quay



Muga



Aqua



Plato llano

Referencia	Medidas	Cantidad
B928144	30 cm Ø	6
B928145	27 cm Ø	12
B928146	21 cm Ø	12
B928147	27 cm Ø	12



Bandeja oval

Referencia	Medidas	Cantidad
B928132	31x24 cm	6



Plato Rissoto

Referencia	Medidas	Cantidad
B928134	38 cm Ø	6



Plato Pasta

Referencia	Medidas	Cantidad
B928218	30 cm Ø	6
B928135	27 cm Ø	6



Ensaladera

Referencia	Medidas	Cantidad
B928217	22 cm Ø	6
B928221	18 cm Ø	12
B928215	14 cm Ø	12



Ensaladera Gourmet

Referencia	Medidas	Cantidad
B928219	20 cm Ø	6
B928220	16 cm Ø	12



Bol oval

Referencia	Medidas	Cantidad
B928133	27x18 cm	6



Fuente rectangular

Referencia	Medidas	Cantidad
B928214	23x16 cm	12

bonna

Viejo Valle
Diseñamos Profesional

Therapy



Plato llano

Referencia	Medidas	Cantidad
B928148	30 cm Ø	6
B928149	27 cm Ø	12
B928150	21 cm Ø	12
B928151	27 cm Ø	12



Bandeja oval

Referencia	Medidas	Cantidad
B928136	31x24 cm	6

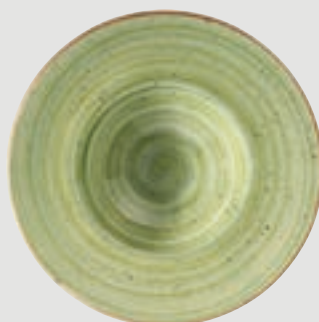

Plato Rissoto

Referencia	Medidas	Cantidad
B928138	38 cm Ø	6



Plato Pasta

Referencia	Medidas	Cantidad
B928226	30 cm Ø	6
B928139	27 cm Ø	6



Ensaladera

Referencia	Medidas	Cantidad
B928225	22 cm Ø	6
B928229	18 cm Ø	12
B928223	14 cm Ø	12



Ensaladera Gourmet

Referencia	Medidas	Cantidad
B928227	20 cm Ø	6
B928228	16 cm Ø	12



Bol oval

Referencia	Medidas	Cantidad
B928137	27x18 cm	6



Fuente rectangular

Referencia	Medidas	Cantidad
B928222	23x16 cm	12



Africa

Borde liso - 0,6 mm espesor



Pizarra rectangular

Referencia	Medidas	Cantidad
B4003	40x13 cm	6
B2575	41x29 cm	12
B2792	40x25 cm	12
B2799	40x13 cm	12
B2576	37x18 cm	12
B2577	32x15 cm	12
B2794	30x20 cm	12
B2795	30x13 cm	12
B2797	25x13 cm	24
B2578	20x13 cm	24
B2579	13x9 cm	48
B2793	40x8 cm	24
B2796	30x8 cm	24
B2798	20x8 cm	24

Pizarra cuadrada

Referencia	Medidas	Cantidad
B4008	34x34 cm	6
B2580	31x31 cm	12
B2800	29x29 cm	12
B2581	27x27 cm	12
B2582	25x25 cm	12
B2801	22x22 cm	12
B2583	20x20 cm	12
B2802	18x18 cm	12
B2584	15x15 cm	24

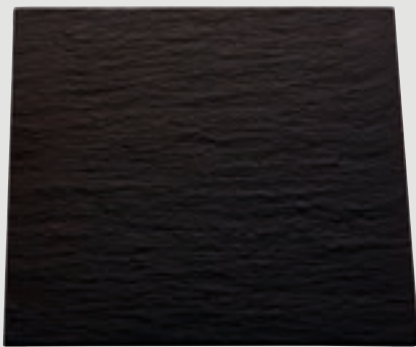

Soft Africa

Borde irregular - 0,5 mm espesor

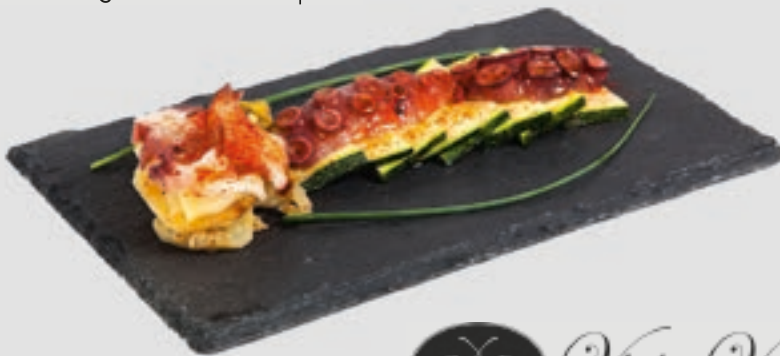

Pizarra rectangular

Referencia	Medidas	Cantidad
B839000	41x29 cm	12
B839001	37x18 cm	12
B839002	32x15 cm	12
B839003	20x13 cm	12
B839004	13x9 cm	24
B839009	40x25 cm	12
B839010	30x20 cm	12
B839011	30x13 cm	12
B839012	30x8 cm	24
B839013	25x13 cm	24
B839014	20x8 cm	24
B839017	53x32 cm	6
B839018	32x26 cm	12
B839019	32x17 cm	12
B839020	26x16 cm	12
B839021	53x16 cm	12



Pizarra cuadrada

Referencia	Medidas	Cantidad
B839005	31x31 cm	12
B839006	27x27 cm	12
B839007	25x25 cm	12
B839015	22x22 cm	12
B839008	20x20 cm	12
B839016	18x18 cm	12



Plato Bordeaux

Referencia	Medidas	Cantidad
B2569	31 cm Ø	12
B2570	28 cm Ø	12
B2571	24 cm Ø	24
B2572	20 cm Ø	36
B2573	15 cm Ø	72
B2574	10 cm Ø	240

Plato Denia

Referencia	Medidas	Cantidad
B2632	28 cm Ø	12
B2633	25 cm Ø	24
B2634	20 cm Ø	24

Plato Vecchio

Referencia	Medidas	Cantidad
B3428	29 cm Ø	6
B3429	26 cm Ø	6
B3430	21 cm Ø	12

Plato Trattoria

Referencia	Medidas	Cantidad
B4123	30 cm Ø	12
B4124	24 cm Ø	12
B4125	18 cm Ø	24

Bol Huitre

Referencia	Medidas	Cantidad
B1967	29x17 cm	12
B1968	19x11 cm	24
B1969R	15x9 cm	24

Bandeja Cairo

Referencia	Medidas	Cantidad
B2608	43x21 cm	12
B2609	38x18 cm	12
B2610	32x13 cm	12
B2611	25x10 cm	12
B2612	20x8 cm	72

Bandeja Kayuko

Referencia	Medidas	Cantidad
B2486	40x18 cm	12
B2487	35x15 cm	24
B2488	30x13 cm	36
B2489	20x9 cm	72

Bandeja Harvest

Referencia	Medidas	Cantidad
B3431	35x22 cm	6
B3432	30x20 cm	6
B3433	30x15 cm	12
B3434	25x15 cm	12
B3435	20x13 cm	24

Bandeja Notte

Referencia	Medidas	Cantidad
B4177	35x25 cm	12
B4178	32x22 cm	24
B4179	26x18 cm	24
B4180	19x13 cm	60
B4181	14x10 cm	120

Bandeja Altamira

Referencia	Medidas	Cantidad
B3421	45x14 cm	6
B3422	41x13 cm	6
B3423	35x12 cm	6



Sprinkle

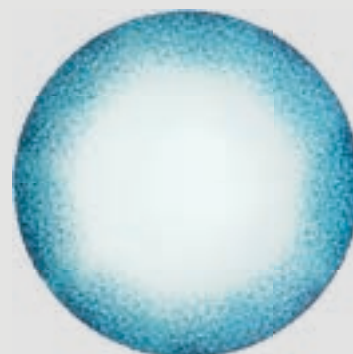

Plato presentación dec. ala

Referencia	Medidas	Cantidad
21125250	33 cm Ø	1



Plato presentación dec. centro

Referencia	Medidas	Cantidad
21125251	33 cm Ø	4



Plato llano

Referencia	Medidas	Cantidad
21125252	28 cm Ø	4
21125253	23 cm Ø	4
21125254	20 cm Ø	4



Bol sopa

Referencia	Medidas	Capacidad	Cantidad
21125255	14 cm Ø	54 cl	4



Taza c/plato

Referencia	Capacidad	Cantidad
21125258	22 cl	6
21125257	9 cl	6



Bol arroz

Referencia	Medidas	Capacidad	Cantidad
21125256	11 cm Ø	33 cl	4

Una decoración de carácter ligero y delicado, diseñada para enfatizar y elevar los mejores sabores.

Mandarín

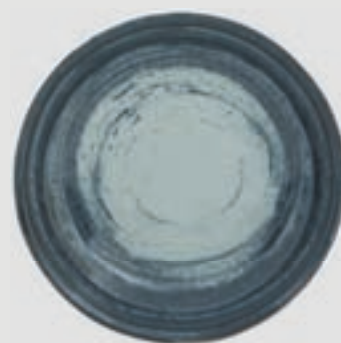

Plato redondo

Referencia	Medidas	Cantidad
21122810	28 cm Ø	12
21123849	25 cm Ø	12
21122812	23 cm Ø	12



Plato cuadrado

Referencia	Medidas	Cantidad
21122813	16x16 cm	16



Plato mantequilla

Referencia	Medidas	Cantidad
21122815	10 cm Ø	6



Taza c/plato

Referencia	Capacidad	Cantidad
21123852	9 cl	6

Con motivos y tonos armoniosos que reproducen el toque rústico de la pintura manual, la colección mandarín propone la relectura de algunas influencias asiáticas, destacando la sobriedad. Un conjunto que une las enseñanzas tradicionales a las tendencias actuales del diseño y de la decoración.



Fuente rectangular

Referencia	Medidas	Cantidad
21122814	32x15 cm	6

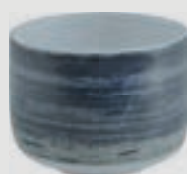

Bol sopa

Referencia	Medidas	Capacidad	Cantidad
21122816	8,9 cm Ø	26 cl	6
21122818	7,7 cm Ø	13 cl	6
21122812	6,2 cm Ø	9 cl	12

Colores disponibles



Verde



Naranja



Gris

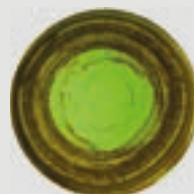

Verde Oscuro

VISTA ALEGRE
 1824

Karma



Plato oval c/bol

Referencia	Medidas	Cantidad
------------	---------	----------

21108772	30x30 cm	1
----------	----------	---



Plato llano

Referencia	Medidas	Cantidad
------------	---------	----------

21108765	28 cm Ø	4
21108767	22 cm Ø	4



Plato hondo

Referencia	Medidas	Cantidad
------------	---------	----------

21108766	27 cm Ø	4
----------	---------	---



Bol

Referencia	Medidas	Cantidad
------------	---------	----------

21108770	17 cm Ø	6
----------	---------	---



Taza c/plato

Referencia	Capacidad	Cantidad
------------	-----------	----------

21108771	9 cl	4
----------	------	---



Bol mini c/plato

Referencia	Capacidad	Cantidad
------------	-----------	----------

21108775	7 cl	4
----------	------	---



Plato redondo

Referencia	Medidas	Cantidad
------------	---------	----------

21118027	29 cm Ø	6
----------	---------	---



Plato oval

Referencia	Medidas	Cantidad
------------	---------	----------

21118025	32x26 cm	6
21118026	30x24 cm	6



Fuente oval

Referencia	Medidas	Cantidad
------------	---------	----------

21118334	47x24 cm	1
21118059	40x20 cm	1



Plato cuadrado

Referencia	Medidas	Cantidad
------------	---------	----------

21118028	29x29 cm	6
21118029	24x24 cm	6



Plato hondo

Referencia	Medidas	Cantidad
------------	---------	----------

21118030	29 cm Ø	5
----------	---------	---



Plato pasta

Referencia	Medidas	Cantidad
------------	---------	----------

21118081	30 cm Ø	1
----------	---------	---



Bol redondo

Referencia	Medidas	Cantidad
------------	---------	----------

21118031	22 cm Ø	1
21118032	13 cm Ø	6



Bol especial

Referencia	Medidas	Cantidad
------------	---------	----------

21118035	28x16 cm	1
21118058	19x10 cm	6



Bol oval

Referencia	Medidas	Cantidad
------------	---------	----------

21118033	27x21 cm	4
21118034	18x14 cm	6

Infinita



Plato grande

Referencia	Medidas	Cantidad
------------	---------	----------

21121478	28 cm Ø	2
----------	---------	---



Plato pequeño

Referencia	Medidas	Cantidad
------------	---------	----------

21121479	22 cm Ø	2
----------	---------	---



VISTA ALEGRE
1824

Mineral



Plato redondo Biscuit

Plato redondo Glaze

Referencia	Medidas	Cantidad
------------	---------	----------

21122762	23 cm Ø	4
----------	---------	---

Referencia	Medidas	Cantidad
------------	---------	----------

21123216	23 cm Ø	4
----------	---------	---



Plato rect Biscuit

Plato rect Glaze

Referencia	Medidas	Cantidad
------------	---------	----------

21122763	23 cm Ø	4
----------	---------	---

Referencia	Medidas	Cantidad
------------	---------	----------

21123217	23 cm Ø	4
----------	---------	---

Temptation



Plato centro pequeño

Referencia	Medidas	Cantidad
------------	---------	----------

21122367	29 cm Ø	4
----------	---------	---



Plato centro grande

Referencia	Medidas	Cantidad
------------	---------	----------

21122366	29 cm Ø	4
----------	---------	---



VISTA ALEGRE
1824

Tecido



Plato plano

Referencia	Medidas	Cantidad
------------	---------	----------

21117389	28 cm Ø	2
----------	---------	---



Plato hondo

Referencia	Medidas	Cantidad
------------	---------	----------

21121416	28 cm Ø	2
----------	---------	---

Terra Stoneware Azul



VISTA ALEGRE
1824



Plato llano

Referencia	Medidas	Cantidad
------------	---------	----------

37002915	28 cm Ø	6
37002926	23 cm Ø	6
37003008	19 cm Ø	6
37003007	16 cm Ø	6



Plato hondo

Referencia	Medidas	Cantidad
------------	---------	----------

37003006	25 cm Ø	6
----------	---------	---



Fuente redonda

Referencia	Medidas	Cantidad
------------	---------	----------

37002928	40 cm Ø	1
----------	---------	---



Bol redondo

Referencia	Medidas	Cantidad
------------	---------	----------

37002927	16 cm Ø	6
----------	---------	---



Fuente redonda

Referencia	Medidas	Cantidad
------------	---------	----------

37003009	18 cm Ø	6
----------	---------	---



Vaso

Referencia	Capacidad	Cantidad
------------	-----------	----------

37003012	38 cl	6
----------	-------	---



Taza café c/plato

Referencia	Capacidad	Cantidad
------------	-----------	----------

37003010	9 cl	6
----------	------	---



Taza té c/plato

Referencia	Capacidad	Cantidad
------------	-----------	----------

37003011	25 cl	6
----------	-------	---

Terra Stoneware Zafiro



Plato llano

Referencia	Medidas	Cantidad
37003031	28 cm Ø	6
37003032	23 cm Ø	6
37003037	19 cm Ø	6
37003036	16 cm Ø	6



Plato hondo

Referencia	Medidas	Cantidad
37003035	25 cm Ø	6



Fuente redonda

Referencia	Medidas	Cantidad
37003034	40 cm Ø	1



Bol redondo

Referencia	Medidas	Cantidad
37003033	16 cm Ø	6



Fuente redonda

Referencia	Medidas	Cantidad
37003038	18 cm Ø	6



Vaso

Referencia	Capacidad	Cantidad
37003041	38 cl	6



Taza café c/plato

Referencia	Capacidad	Cantidad
37003039	9 cl	6



Taza té c/plato

Referencia	Capacidad	Cantidad
37003040	25 cl	6



Terra Stoneware Arena



Plato llano

Referencia	Medidas	Cantidad
37002936	28 cm Ø	6
37002937	23 cm Ø	6
37003015	19 cm Ø	6
37003014	16 cm Ø	6



Plato hondo

Referencia	Medidas	Cantidad
37003013	25 cm Ø	6



Fuente redonda

Referencia	Medidas	Cantidad
37002939	40 cm Ø	1



Bol redondo

Referencia	Medidas	Cantidad
37002938	16 cm Ø	6



Fuente redonda

Referencia	Medidas	Cantidad
37003016	18 cm Ø	6



Vaso

Referencia	Capacidad	Cantidad
37003019	38 cl	6



Taza café c/plato

Referencia	Capacidad	Cantidad
37003017	9 cl	6



Taza té c/plato

Referencia	Capacidad	Cantidad
37003018	25 cl	6

Utopía



Plato llano

Referencia	Medidas	Cantidad
21127753	32 cm Ø	4
21127754	29 cm Ø	4
21127756	23 cm Ø	4
21127757	17 cm Ø	



Plato pasta

Referencia	Medidas	Cantidad
21127758	28 cm Ø	4



Plato hondo

Referencia	Medidas	Cantidad
21127755	27 cm Ø	4



Ensaladera bol

Referencia	Medidas	Cantidad
21127760	22 cm Ø	4
21127761	16 cm Ø	4
21127762	11 cm Ø	4



Taza/platillo

Referencia	Capacidad	Cantidad
21127763	42 cl	4
21128452	24 cl	4
21128450	11 cl	4
21128453	17 cl	
21128451	13 cl	



Fuente oval

Referencia	Medidas	Cantidad
21127759	35x28 cm	4



Tetera

Referencia	Capacidad	Cantidad
21128448	1,32 Lt	4
21128449	0,48 Lt	



Lechera

Referencia	Capacidad	Cantidad
21127767	26 cl	4

VISTA ALEGRE
 1824

Sandía

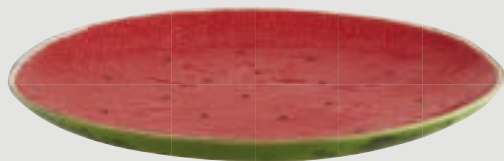

Fuente redonda

Referencia	Medidas	Cantidad
65020802	43 cm Ø	1



Ensaladera

Referencia	Medidas	Cantidad
65020807	35 cm Ø	1
65020808	28 cm Ø	1

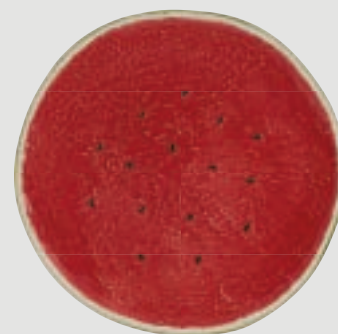

Plato llano

Referencia	Medidas	Cantidad
65020803	32,5 cm Ø	1
65030804	21 cm Ø	1



Bol c/tapa

Referencia	Medidas	Cantidad
65018693	26x22 cm	1
65018687	21x19 cm	1
65018681	13x12 cm	1



Bol c/tapa

Referencia	Medidas	Cantidad
65018690	26x22 cm	1
65018684	21x19 cm	1
65018678	13x12 cm	1



Bol c/tapa

Referencia	Medidas	Cantidad
65018648	26x22 cm	1
65018645	21x19 cm	1
65018642	13x12 cm	1



Plato llano

Referencia	Medidas	Cantidad
65018597	32,5 cm Ø	1
65003120	20 cm Ø	1



Melón



Frutero

Referencia	Capacidad	Cantidad
65018596	3,7 Lt	1



Bol/ensaladera

Referencia	Medidas	Cantidad
65003300	25 cm Ø	1
65003466	15 cm Ø	1
65003467	13 cm Ø	1



Terrina

Referencia	Capacidad	Cantidad
65018599	3,7 Lt	1

Arborescence



Plato llano

Referencia	Referencia	Referencia	Medidas	Cantidad
648324	648325	648326	31 cm	2
648279	648280	648281	28 cm	6
648342	648344	648345	26 cm	6
648353	648474	648475	21,5 cm	6
648362	648364	648365	16 cm	6



REVOL

Plato hondo

Referencia	Referencia	Referencia	Medidas	Cantidad
648288	648289	648290	24 cm	6
648297	648298	648299	19 cm	6
648390	648391	648392	15 cm	6



Fuente recta

Referencia	Referencia	Referencia	Medidas	Cantidad
648307	648308	648309	32x23 cm	2
648334	648335	648336	30x15 cm	6

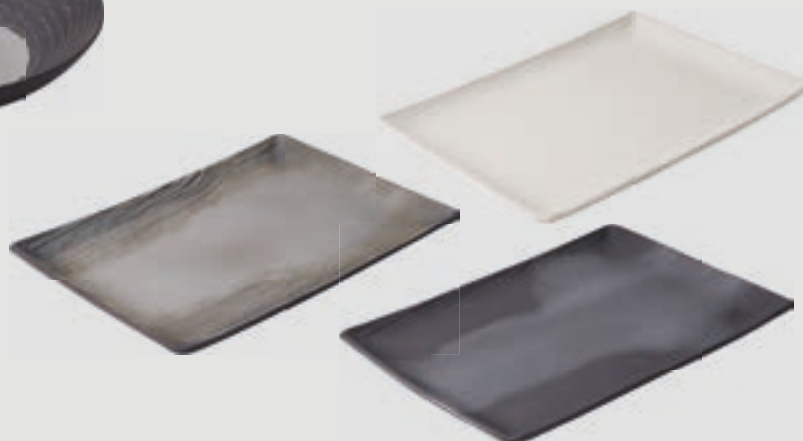



Ensaladera

Referencia	Referencia	Referencia	Medidas	Cantidad
650476	650477	650478	27,3 cm	1

Cuenco

Referencia	Referencia	Referencia	Medidas	Cantidad
648941	648942	648943	14 cm	6
650001	650002	650003	16 cm	6
648398	648399	648400	7 cm	6



Taza - Mug

Referencia	Referencia	Referencia	Capacidad	Cantidad
648406	648407	648408	8 cl	6
648843	648844	648845	18 cl	6
648431	648432	648433	25 cl	6



Bol arroz

Referencia	Referencia	Referencia	Medidas	Cantidad
648926	648927	648928	12 cm	6



Equinaxe



Plato llano



Referencia	Referencia	Referencia	Medidas	Cantidad
649503	649502	649501	31 cm	2
649500	649499	649497	28 cm	6
650423	650420	650421	26 cm	6
650432	650430	650431	24 cm	6
649496	849495	649494	21,5 cm	6
649493	649492	649491	16 cm	6



Plato hondo



Referencia	Referencia	Referencia	Medidas	Cantidad
649559	649557	649558	27 cm	4
649506	649505	649504	24 cm	6
649579	649578	649577	19 cm	6
649589	649588	649587	15 cm	6



Bol arroz

Referencia	Referencia	Referencia	Medidas	Cantidad
649596	649595	649594	12 cm	6



Bol plano

Referencia	Referencia	Referencia	Medidas	Cantidad
649509	649508	649507	14 cm	6



Bol cónico

Referencia	Referencia	Referencia	Capacidad	Cantidad
649611	649609	649610	25 cl	4
649607	649605	649606	5 cl	6



REVOL

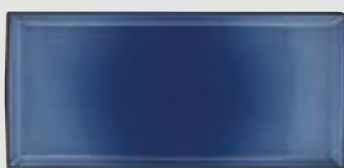

Dim Sum

Referencia	Referencia	Referencia	Medidas	Cantidad
649524	649522	649523	22 cm	1

Fuente oval

Referencia	Referencia	Referencia	Medidas	Cantidad
649556	649554	649555	35 cm	4

Fuente recta

Referencia	Referencia	Referencia	Medidas	Cantidad
649568	649566	649567	32,5 cm	4

- Cirrus Bleu
- Noir
- Poivre



Solid

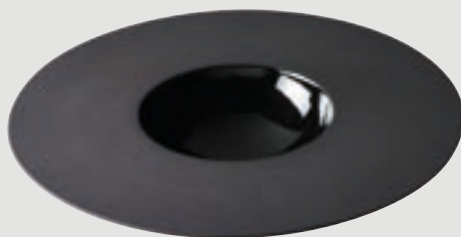

Plato esfera

Referencia	Medidas	Cantidad
645673	30 cm	4



650354



650355

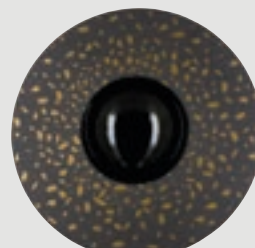

650356



Baguette

Referencia	Medidas	Cantidad
645765	8,5x5 cm	6
645768	15x5 cm	6
645866	27x5 cm	6



Plato hondo

Referencia	Referencia	Referencia	Medidas	Cantidad
649099	649100	649101	23,5 cm	4
647495	647496	647497	17,5 cm	4
○	●	●		



Referencia	Referencia	Referencia	Medidas	Cantidad
Ensaladera 649096	649097	649098	20 cm - 1,5 lt	3
Bol 646369	646370	646371	13 cm - 0,55 lt	6
Bol 646398	646399	646400	11 cm - 0,30 lt	6
Bol mini 647322	647323	647324	5 cm - 0,03 lt	6
○	●	●		



Plato tapas

Referencia	Referencia	Referencia	Medidas	Cantidad
646231	646232	646233	16 cm	6
○	●	●		

Tubo



Referencia	Referencia	Referencia	Capacidad	Cantidad
646428	646429	646430	5 cl	6
○	●	●		



REVOL

Bol tapas

Referencia	Referencia	Referencia	Capacidad	Cantidad
646421	646422	646423	15 cl	6
○	●	●		



Jarra

Referencia	Referencia	Referencia	Capacidad	Cantidad
644309	644375	644385	0,10 lt	4
644306	644378	644386	0,25 lt	4
644303	644346	644387	0,50 lt	4
644837	644833	644836	0,75 lt	4
○	●	●		



Salsera

Referencia	Referencia	Referencia	Capacidad	Cantidad
644988	644989	644990	20 cl	4
○	●	●		



Sopera

Referencia	Referencia	Referencia	Capacidad	Cantidad
646403	646407	646408	45 cl	6
○	●	●		



Saturno



Cúpula plato hondo

Referencia	Cantidad
------------	----------

04514320001	4
04514300001	4



Plato llano

Referencia	Medidas	Cantidad
------------	---------	----------

04500030001	33 cm Ø	6
04600100001	29 cm Ø	12
04500200001	24 cm Ø	12
04500400001	17 cm Ø	12



Plato hondo gourmet

Referencia	Medidas	Cantidad
------------	---------	----------

04500060001	29 cm Ø	12
04514290001	25 cm Ø	12



Plato hondo

Referencia	Medidas	Cantidad
------------	---------	----------

04600250001	25 cm Ø	12
-------------	---------	----



Ensaladera oval

Referencia	Medidas	Cantidad
------------	---------	----------

04500780001	33x18 cm	1
04500800001	25x13 cm	2
04500900001	17x9 cm	8
04510150001	10x7 cm	12



Bol

Referencia	Medidas	Cantidad
------------	---------	----------

04503690001	14 cm Ø	12
04510160001	10 cm Ø	12



Tacerío

Referencia	Capacidad	Cantidad
------------	-----------	----------

04501810001	34 cl	12
04501910001	26 cl	12
04502100001	20 cl	12
04501990001	10 cl	12
04502010001	7,5 cl	12

Fuente oval

Referencia	Medidas	Cantidad
------------	---------	----------

0450037001	57x24 cm	1
0450038001	48x21 cm	1
0450039001	38x20 cm	1



04501820001	18 cm Ø	12
04502110001	16 cm Ø	12
04502020001	12 cm Ø	12

costaverde



Boheme

Aria



Plato llano

Plato hondo

Plato llano

Plato hondo

Referencia	Medidas	Cantidad
------------	---------	----------

04100150001	30x26 cm	12
04100300001	23x20 cm	12

Referencia	Medidas	Cantidad
------------	---------	----------

0450037001	20x18 cm	12
------------	----------	----

Referencia	Medidas	Cantidad
------------	---------	----------

04200150001	30x26 cm	12
04200300001	23x20 cm	12
04200250001	20x18 cm	12

Referencia	Medidas	Cantidad
------------	---------	----------

04200060001	30x26 cm	12
-------------	----------	----

Opera



Plato llano

Plato hondo

Fuente

Referencia	Medidas	Cantidad
------------	---------	----------

04000030001	36x30 cm	6
04000150001	31x26 cm	12
04000300001	25x21 cm	12
04000350001	21x18 cm	12

Referencia	Medidas	Cantidad
------------	---------	----------

0400025001	21x18 cm	12
------------	----------	----

Referencia	Medidas	Cantidad
------------	---------	----------

04000450001	43x30 cm	1
04000500001	37x26 cm	1
04000550001	33x24 cm	1

Fuente larga

Referencia	Medidas	Cantidad
------------	---------	----------

04000370001	57x23 cm	1
04000380001	47x19 cm	1
04000490001	38x14 cm	1



costaverde

Concrete



Plato rectangular

Referencia	Medidas	Cantidad
9129688	27,5x13 cm	4



Plato cuadrado

Referencia	Medidas	Cantidad
9129690	28x28 cm	2



Plato redondo

Referencia	Medidas	Cantidad
9129689	28,5 cm Ø	4



Holi Carbone



Plato llano negro

Referencia	Medidas	Cantidad
9129681	28,5 cm Ø	6
9129687	16 cm Ø	6



Plato llano negro

Referencia	Medidas	Cantidad
9129682	25,5 cm Ø	6
9129684	21,5 cm Ø	6



Plato llano rojo

Referencia	Medidas	Cantidad
9129675	28,5 cm Ø	6
9129679	16 cm Ø	6



Plato llano rojo

Referencia	Medidas	Cantidad
9129677	25,5 cm Ø	6
9129678	21,5 cm Ø	6



Plato gourmet

Referencia	Medidas	Cantidad
7534248	28 cm Ø	6



Plato cuadrado

Referencia	Medidas	Cantidad
7534246	27x27 cm	12



Plato cuadrado

Referencia	Medidas	Cantidad
7534245	20x20 cm	12



Plato hondo

Referencia	Medidas	Cantidad
7534247	26 cm Ø	6



Plato triangular

Referencia	Medidas	Cantidad
7534250	29x19 cm	6



Plato triangular

Referencia	Medidas	Cantidad
7534249	21x14 cm	12



Bol triangular

Referencia	Medidas	Cantidad
7534252	14x10 cm	12



Bol triangular

Referencia	Medidas	Cantidad
7534251	12x8 cm	12



Plato llano blanco

Referencia	Medidas	Cantidad
A02/0101	27,5 cm Ø	24
A02/0102	21 cm Ø	36
A02/0103	17 cm Ø	36



Plato hondo blanco

Referencia	Medidas	Cantidad
A0148	27 cm Ø	12
A02/0104	23 cm Ø	36
A0150	20 cm Ø	48



Plato pasta

Referencia	Medidas	Cantidad
A0149	30,5 cm Ø	12



Plato presentación

Referencia	Medidas	Cantidad
A02/0105	31 cm Ø	6

CRISTALERÍA

Glassware • Verrerie • Vetreria • Glaswaren





100 00 37



100 00 35



100 00 01



100 00 02



100 00 07

Código	Descripción	Capacidad	Altura
100 00 37	Copa Burdeos	660 ml	223,5 mm
100 00 35	Copa Burdeos	540 ml	212,0 mm
100 00 01	Copa Tinto	450 ml	205,0 mm
100 00 02	Copa Blanco	350 ml	195,5 mm
100 00 07	Copa Champagne	200 ml	212,0 mm





Las proporciones bien equilibradas y elegantes de la copa Exquisit se combinan para crear una copa atractiva y funcional. En comparación con otros diseños, la Exquisit destaca por la forma independiente de su cáliz y la curvatura suave con la que continúa el tallo, para finalizar en una base sólida y resistente, que hacen que esta copa tenga el equilibrio perfecto.

Su diseño estético y su alta durabilidad hacen de la Exquisit la copa perfecta para la restauración y la hostelería, con una relación calidad/precio inmejorable.

Código	Descripción	Capacidad	Altura
1470035	Copa Burdeos	645 ml	230 mm
1470001	Copa Tinto	480 ml	215 mm
1470003	Copa Blanco	420 ml	211 mm
1470002	Copa Blanco	350 ml	203 mm
1470029	Copa Champagne	265 ml	223 mm
1470007	Copa Cava	175 ml	221 mm
1477402	Copa Negra	350 ml	203 mm
3520012	Vaso	465 ml	120 mm



3520012





3770000



3770001



3770002



3770007

Código	Descripción	Capacidad	Altura
3770000	Copa Burdeos	545 ml	220 mm
3770001	Copa Tinto	490 ml	225 mm
3770002	Copa Blanco	365 ml	220 mm
3770007	Copa Cava	200 ml	225 mm





2200000



2200035



2200001



2200002



2200003



2200007

Código	Descripción	Capacidad	Altura
2200000	Copa Burdeos	695 ml	231 mm
2200035	Copa Burdeos	645 ml	238 mm
2200001	Copa Tinto	450 ml	225 mm
2200002	Copa Blanco	350 ml	214 mm
2200003	Copa Blanco	285 ml	208 mm
2200007	Copa Champagne	188 ml	224 mm



Probablemente, el mejor cristal del mundo.



*Más duro y brillante.
Más resistente a las roturas.
Mas resistente al lavavajillas.*

Un salto revolucionario en la fabricación de cristal.

Tras una larga e intensa investigación. Schott Zwiesel ha desarrollado un nuevo cristal libre de plomo. En su composición entran óxidos de zinc, titanio y circonio.

Combinado con un nuevo proceso de fabricación, surge un cristal de cualidades extraordinarias en cuanto a dureza, brillo y sonoridad, muy resistente a la rotura y a la acción corrosiva del lavavajillas.

Un cristal muy duro, sonoro y brillante.

El nuevo cristal **Tritan®** posee grados de sonoridad, dureza y brillantez superiores. Las pruebas de laboratorio avalan que después de 1.000 vueltas en arena de cuarzo, la superficie de las copas fabricadas con Tritan® no presenta signos de rayaduras. La exposición continuada a la luz intensa tampoco merma el brillo radiante de las copas.





N-0



N-2



N-77



N-130



N-140

Código	Descripción	Capacidad	Altura
119958	Chardonnay N-0	37,2 cl	199 mm
119959	Riestling N-2	31,3 cl	191 mm
119962	Champán N-77	24,5 cl	204 mm
119960	Burdeos N-130	50,5 cl	214 mm
119961	Borgoña N-140	61,6 cl	199 mm



Compacta, sofisticada y excepcionalmente funcional. Éste el concepto de la copa Fiesta y su versátil colección se adapta a todos los ambientes. Desarrollada para uso profesional y con unos requerimientos de forma, calidad y funcionalidad.





N-140



N-130



N-1



N-0



N-7

Código	Descripción	Capacidad	Altura
115589	Borgoña N-140	78,3 cl	221 mm
115588	Burdeos N-130	63,3 cl	230 mm
115587	Tintos N-1	50,6 cl	224 mm
115586	Blancos N-0	34,9 cl	208 mm
115590	Cava N-7	22,8 cl	222 mm





Código	Descripción	Capacidad	Altura
118609	Vino N-1	43,7 cl	244 mm
118602	Chardonnay N-0	38,5 cl	229 mm
118604	Riesling N-2	31,6 cl	222 mm
118607	Champán N-77	29,8 cl	238 mm
118605	Agua N-32	38,5 cl	181 mm
118608	Burdeos N-130	63,0 cl	261 mm
118609	Borgoña N-140	66,0 cl	233 mm





Código	Descripción	Capacidad	Altura
174487	Copa Vino N-1	41,5 cl	205 mm
133903	Copa Vino N-0	32,0 cl	197 mm
133920	Copa Vino N-2	25,0 cl	187 mm
167703	Copa Vino N-3	20,0 cl	180 mm
133934	Copa Cava N-7	19,0 cl	210 mm
172927	Copa Borgoña N-140	58,5 cl	195 mm



Taste



Código	Descripción	Capacidad	Altura
115671	Copa Vino N-1	49,7 cl	225 mm
115670	Copa Vino N-0	35,6 cl	211 mm
115674	Copa Cava N-7	28,3 cl	231 mm
115672	Copa Burdeos N-130	65,6 cl	237 mm
115673	Copa Borgoña N-140	78,2 cl	227 mm





N-1



N-0



N-2



N-7



N-130



N-140



Código	Descripción	Capacidad	Altura
112413	Copa Vino N-1	54,0 cl	244 mm
112412	Copa Vino N-0	40,8 cl	232 mm
112414	Copa Vino N-2	30,0 cl	220 mm
112415	Copa Cava N-7	20,9 cl	252 mm
112420	Copa Burdeos N-130	68,0 cl	267 mm
112421	Copa Borgoña N-140	69,2 cl	234 mm

Classico



N-1



N-0



N-2



N-7



N-130



N-140



Código	Descripción	Capacidad	Altura
106220	Copa Vino N-1	54,5 cl	240 mm
106219	Copa Vino N-0	40,8 cl	225 mm
106221	Copa Vino N-2	31,2 cl	210 mm
106223	Copa Cava N-7	21,0 cl	242 mm
106226	Copa Burdeos N-130	64,5 cl	250 mm
106227	Copa Borgoña N-140	81,4 cl	230 mm

ARCOROC

Los profesionales de la sumillería buscan copas que respondan a sus exigencias de perfección y refinamiento.

Su deseo: una mesa en su restaurante compuesta por artículos finos, ligeros y extremadamente transparentes.

Su exigencia profesional: Un uso intensivo diario que reclama productos con una gran resistencia a los golpes y a los detergentes. Para responder a ese doble desafío de excelencia estética y de resistencia, el centro de investigación Arc, presenta una nueva generación de cristalino sin plomo: KRYSTA, el cristalino con un rendimiento excepcional.



Mayor finura y resistencia



Mayor transparencia y brillo



Sonido claro y puro



Brillo extremo y duradero





ARCOROC

Reveal Up

CRISTALERÍA



9219014



9218909



9218742



9218743



9218908



9218907

Código	Descripción	Capacidad	Altura
9219014	Copa Vino	55 cl	236 mm
9218909	Copa Vino	50 cl	247 mm
9218742	Copa Vino	45 cl	222 mm
9218743	Copa Vino	40 cl	232 mm
9218908	Copa Vino	30 cl	217 mm
9218907	Copa Flauta	21 cl	234 mm
9219522	Vaso Soft	40 cl	93 mm
9219524	Vaso Intense	40 cl	86 mm



9219522



9219524



Cabernet

ARCOROC



CRISTALERÍA



1121198



1121197



1121196



1121195



1121194



8853468

Código	Descripción	Capacidad	Altura
1121198	Tulipe	75 cl	240 mm
1121197	Tulipe	58 cl	230 mm
1121196	Tulipe	47 cl	220 mm
1121195	Tulipe	35 cl	202 mm
1121194	Tulipe	25 cl	180 mm
8853468	Tulipe	19 cl	165 mm
9222789	Copa Vino	58 cl	220 mm
9222790	Copa Vino	47 cl	210 mm
9222788	Copa Vino	35 cl	200 mm



9222789



9222790



9222788





Código	Descripción	Capacidad	Altura
9261013	Tannic	55 cl	232 mm
9261012	Soft	47 cl	228 mm
9261011	Universal Tasting	40 cl	231 mm
9261010	Round	37 cl	210 mm
9261009	Sweet	27 cl	190 mm
9261008	Pro Tasting	32 cl	180 mm
9261051	Effervescent	20 cl	233 mm
9261041	Vaso Alto	35 cl	120 mm
9261033	Vaso Bajo	38 cl	92 mm



Grandes Cepages



CRISTALERÍA

ARCOROC



9226245



9226101



9290935



9219088



9226250



9219198

Código	Descripción	Capacidad	Altura
9226245	Copa Tinto	62 cl	238 mm
9226101	Copa Tinto	47 cl	227 mm
9290935	Copa Tinto	35 cl	210 mm
9219088	Copa Tinto	25 cl	185 mm
9226250	Copa Flauta	24 cl	235 mm
9219198	Copa Flauta	19 cl	204 mm





9227695



9227696



9227697



9227698



9227700

Código	Descripción	Capacidad	Altura
9227695	Copa Agua grande	41 cl	205 mm
9227696	Copa Agua	31 cl	195 mm
9227697	Copa Tinto	25 cl	185 mm
9227698	Copa Blanco	20 cl	180 mm
9227700	Copa Cava	19 cl	210 mm



Viña

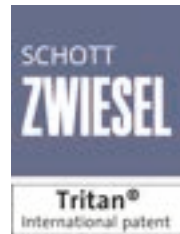

N-1



N-0



N-2



N-7



N-130



N-140

Código	Descripción	Capacidad	Altura
110459	Copa Vino N-1	58 cl	227 mm
110458	Copa Vino N-0	45 cl	217 mm
110485	Copa Vino N-2	35 cl	203 mm
110488	Copa Cava N-7	27 cl	225 mm
110496	Copa Burdeos N-130	16 cl	225 mm
110499	Copa Borgoña N-140	16 cl	221 mm





9202091

9202006

9202007

9202010

9202090

Código	Descripción	Capacidad	Altura
9202091	Copa Vino	58 cl	255 mm
9202006	Copa Vino	45 cl	234 mm
9202007	Copa Vino	35 cl	219 mm
9202010	Copa Vino	27 cl	202 mm
9202090	Copa Cava Flauta	16 cl	224 mm



Sequence



Finura de la boca (1,2 mm),
confort al contacto con los labios

El perfil sigue unas perfectas
líneas continuas

Base ancha, mejor respiración
del vino

Pie delicado con unión lisa

Base del pié plana que favorece la
estabilidad y evita la retención del
agua en el lavavajillas



Código	Descripción	Capacidad	Altura
9129951	Copa Vino	74 cl	235 mm
9129950	Copa Vino	53 cl	235 mm
9129949	Copa Vino	44 cl	227 mm
9129948	Copa Vino	35 cl	210 mm
9129947	Copa Vino	17 cl	208 mm

El modelo Spirit de Hoterali@ combina robustez y elegancia con la mejor relación calidad/precio.



Código	Descripción	Capacidad	Altura
3642SCL58	Copa Vino	58 cl	213 mm
3656SCL46	Copa Vino	46 cl	207 mm
3565SCL35	Copa Vino	35 cl	196 mm
3565SCL24	Copa Vino	25 cl	180 mm
3656SCL20	Copa Cava Flauta	20 cl	198 mm



Lira



Agua

Vino

Flauta

Código	Descripción	Capacidad	Altura
10511650	Copa Agua	23 cl	156 mm
10511651	Copa Vino	16 cl	140 mm
10511653	Copa Flauta	15 cl	169 mm

Normandie

ARCOROC

Agua

Vino

Jerez

Cava

Código	Descripción	Capacidad	Altura
1031120	Copa Agua	23 cl	174 mm
1031121	Copa Vino	16 cl	145 mm
1031122	Copa Jerez	11 cl	127 mm
1231123	Copa Cava	15 cl	174 mm

Lineal



Gran vino

Agua

Vino

Jerez

Cava

Código	Descripción	Capacidad	Altura
9239515	Gran vino	45 cl	215 mm
9233570	Agua	31 cl	197 mm
9233572	Vino	25 cl	174 mm
9233571	Jerez	19 cl	165 mm
9233569	Cava	18 cl	196 mm

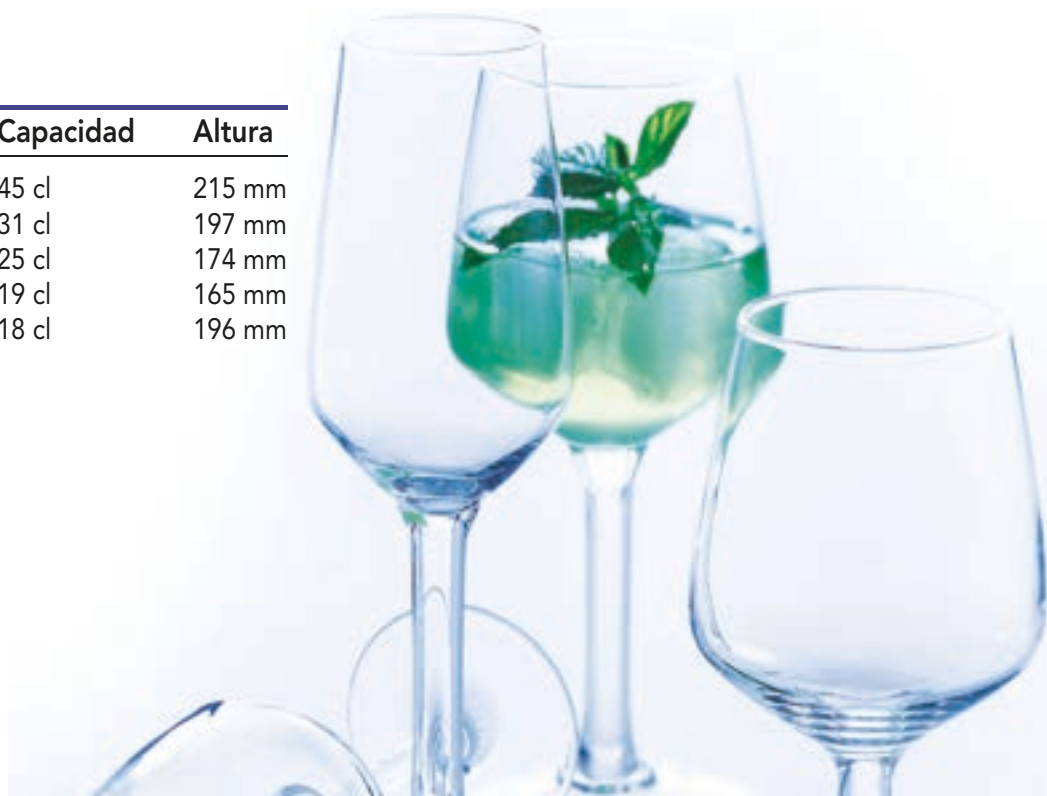

Vesubio



Código	Descripción	Capacidad	Altura
9214613	Copa Mesa	23 cl	122 mm
9215354	Copa Mesa	14 cl	109 mm
9214612	Copa Zumó	20 cl	155 mm
9216021	Copa Flauta	15 cl	150 mm

Suecia

ARCOROC



Código	Descripción	Capacidad	Altura
1051610	Copa Agua	25 cl	134 mm
1051611	Copa Vino	20 cl	124 mm

CRISTALERÍA

Princesa



Código	Descripción	Capacidad	Altura
1051719	Gran vino	42 cl	212 mm
1051720	Agua	31 cl	197 mm
1051721	Agua pequeña	23 cl	174 mm
1051723	Vino	19 cl	165 mm
1051722	Vino pequeña	14 cl	153 mm
1051724	Jerez	9 cl	139 mm
1051726	Cava	15 cl	196 mm





XL

Large

Medium

Small

Flute

Código	Descripción	Capacidad	Altura
365700	Copa XL	64 cl	243 mm
365710	Copa Large	56 cl	233 mm
365720	Copa Medium	47 cl	220 mm
365730	Copa Small	38 cl	207 mm
365740	Copa Flute	28 cl	243 mm





XL

Large

Medium

Small

XS

Flute

Código	Descripción	Capacidad	Altura
365780	Copa XL	65,5 cl	243 mm
365781	Copa Large	57 cl	235 mm
365782	Copa Medium	46,5 cl	220 mm
365783	Copa Small	38,5 cl	210 mm
365784	Copa XS	22,5 cl	185 mm
365785	Copa Flute	32 cl	239 mm



Riserva



Burdeos

Borgoña

Nebbiolo

Cabernet

Barolo

Cava

Código	Descripción	Capacidad	Altura
166150	Burdeos	53 cl	233 mm
166820	Borgoña	40 cl	212 mm
166860	Nebbiolo	50 cl	224 mm
166870	Cabernet	39 cl	212 mm
166170	Barolo	46 cl	195 mm
166220	Cava	21 cl	220 mm



New Kalix



Burgundy

Goblet

Agua

Vino

Cava

Código	Descripción	Capacidad	Altura
136100	Copa Burgundy	43 cl	200 mm
136140	Copa Goblet	35 cl	188 mm
136130	Copa Agua	27 cl	180 mm
136110	Copa Vino	22 cl	169 mm
136120	Copa Cava	17 cl	196 mm





Código	Descripción	Capacidad	Altura
192342	Copa Vino XL	65 cl	240 mm
192210	Copa Vino L	55 cl	230 mm
192200	Copa Vino M	44 cl	216 mm
192341	Copa Vino S	35 cl	160 mm
192340	Copa Vino XS	19 cl	160 mm
192343	Copa Cava	23 cl	235 mm



Código	Descripción	Capacidad	Altura
192346	Vaso Cooler	43 cl	145 mm
192345	Vaso Long Drink	39 cl	129 mm
192344	Vaso D.O.F.	38 cl	100 mm





V1093



V1092



V1091



V1090



V1089

Código	Descripción	Capacidad	Altura
V1093	Copa Vino Victoria	58 cl	230 mm
V1092	Copa Vino Victoria	47 cl	221 mm
V1091	Copa Vino Victoria	35 cl	202 mm
V1090	Copa Vino Victoria	25 cl	182 mm
V1089	Copa Cava Victoria	17 cl	192 mm





V1082



V1083



V1084



V1085



V1086

Código	Descripción	Capacidad	Altura
V1082	Copa Platine Vino	58 cl	230 mm
V1083	Copa Platine Vino	44 cl	220 mm
V1084	Copa Platine Vino	31 cl	202 mm
V1085	Copa Platine Vino	25 cl	182 mm
V1086	Copa Platine Cava	17 cl	205 mm



Mencia



V0265



V0264



V0263



V0262



V0290

Código	Descripción	Capacidad	Altura
V0265	Copa Mencia Vino	58 cl	235 mm
V0264	Copa Mencia Vino	44 cl	230 mm
V0263	Copa Mencia Vino	31 cl	208 mm
V0262	Copa Mencia Vino	25 cl	192 mm
V0290	Copa Mencia Cava	17 cl	205 mm



Syrah



V0176



V0177



V0178



V0179



V0180

Código	Descripción	Capacidad	Altura
V0176	Copa Syrah Vino	58 cl	230 mm
V0177	Copa Syrah Vino	47 cl	220,5 mm
V0178	Copa Syrah Vino	35 cl	202 mm
V0179	Copa Syrah Vino	25 cl	182 mm
V0180	Copa Syrah Cava	17 cl	192 mm





V0759



V0758



V0757



V0755



V0754

Código	Descripción	Capacidad	Altura
V0759	Copa Vino Vintage	56 cl	217 mm
V0758	Copa Vino Vintage	42 cl	205 mm
V0757	Copa Vino Vintage	25 cl	187 mm
V0755	Copa Vino Vintage	20 cl	180 mm
V0754	Copa Cava Vintage	19 cl	210 mm



Primary

ARCOROC

9275725

9275724

9275723

Código	Descripción	Capacidad	Altura
9275725	Vaso Bajo	27 cl	93 mm
9275724	Vaso Alto	36 cl	100 mm
9275723	Vaso Alto	44 cl	105 mm



Lima



9122356

9293368

9293367

Código	Descripción	Capacidad	Altura
9122356	Vaso Alto	45 cl	160 mm
9293368	Vaso Alto	38 cl	110 mm
9293367	Vaso Bajo	35 cl	80 mm



Prysm



9221513

9221514

9221515

Código	Descripción	Capacidad	Altura
9221513	Vaso Alto	35 cl	125 mm
9221514	Vaso Bajo	37 cl	96 mm
9221515	Vaso Bajo	27 cl	88 mm





Código	Descripción	Capacidad	Altura
1031238	Vaso Alto	65 cl	178 mm
8838939	Vaso Alto	46 cl	160 mm
1031236	Vaso Alto	42 cl	130 mm
8829903	Vaso Alto	35 cl	122 mm
8829878	Vaso Alto Estrecho	31 cl	140 mm
1031232	Vaso Alto Estrecho	20 cl	137 mm
1031233	Vaso Bajo	27 cl	98 mm
1121805	Vaso Bajo	20 cl	81 mm
1031231	Vaso Bajo	16 cl	73 mm



Princesa

Código	Descripción	Capacidad	Altura
1121636	Vaso Alto	43 cl	163 mm
1121321	Vaso Alto	34 cl	148 mm
1121357	Vaso Alto	28 cl	127 mm
1031242	Vaso Alto	24 cl	110 mm
1031241	Vaso Alto	18 cl	127 mm
1031245	Vaso Bajo	32 cl	79 mm
8850778	Vaso Bajo	22 cl	79 mm

Islande



Código	Descripción	Capacidad	Altura
1031157	Vaso Alto	36 cl	170 mm
10067	Vaso Alto	33 cl	157 mm
1031154	Vaso Alto	31 cl	166 mm
1031152	Vaso Alto	16 cl	100 mm
1121555	Vaso Alto	10 cl	87 mm
10068	Vaso Bajo	38 cl	96 mm
1031155	Vaso Bajo	30 cl	93 mm
1031153	Vaso Bajo	20 cl	84 mm

Banquet



SCHOTT
ZWIESEL

Tritan®
International patent

Código	Descripción	Capacidad	Altura
128089	Vaso Alto	54 cl	156 mm
974258	Vaso Alto	42 cl	142 mm
974244	Vaso Alto	32 cl	120 mm
128075	Vaso Bajo	40 cl	85 mm
978483	Vaso Bajo	33 cl	83 mm
974261	Vaso Bajo	26 cl	81 mm



Viña



Código	Descripción	Capacidad	Altura
114674	Vaso Alto	56 cl	127 mm
114672	Vaso Bajo	60 cl	101 mm



Pure



Código	Descripción	Capacidad	Altura
112419	Vaso Alto	54 cl	165 mm
113771	Vaso Alto	36 cl	144 mm
112841	Vaso Alto	25 cl	140 mm
112417	Vaso Bajo	39 cl	90 mm
112844	Vaso Bajo	31 cl	83 mm





Código	Descripción	Capacidad	Altura
4527214	Vaso Tumbler verde	470 ml	120 mm
4527314	Vaso Tumbler ámbar	470 ml	120 mm
4527014	Vaso Tumbler azul	470 ml	120 mm
4527114	Vaso Tumbler rojo	470 ml	120 mm



Código	Descripción	Capacidad	Altura
3527312-E	Vaso Elements ámbar	465 ml	120 mm
3527112-E	Vaso Elements rojo	465 ml	120 mm
3528112-E	Vaso Elements lila	465 ml	120 mm
3527712-E	Vaso Elements rosa	465 ml	120 mm
3527012-E	Vaso Elements azul	465 ml	120 mm
3527912-E	Vaso Elements azul claro	465 ml	120 mm
3527812-E	Vaso Elements gris	465 ml	120 mm
3527512-E	Vaso Elements marrón	465 ml	120 mm
3527612-E	Vaso Elements verde oliva	465 ml	120 mm
3527212-E	Vaso Elements verde	465 ml	120 mm



Código	Descripción	Capacidad	Altura
3527512-T	Vaso Twister marrón	465 ml	120 mm
3527612-T	Vaso Twister verde oliva	465 ml	120 mm
3527912-T	Vaso Twister azul	465 ml	120 mm
3527812-T	Vaso Twister gris	465 ml	120 mm
3527212-T	Vaso Twister verde	465 ml	120 mm
3527312-T	Vaso Twister ámbar	465 ml	120 mm
3527712-T	Vaso Twister rosa	465 ml	120 mm



Código	Descripción	Capacidad	Altura
956069	Vaso Alto	48 cl	160 mm
956055	Vaso Bajo	40 cl	95 mm

Iceberg



París



Código	Descripción	Capacidad	Altura
577705	Vaso Alto N-79	33 cl	156 mm
571703	Vaso Alto N-42	27 cl	142 mm
813893	Vaso Alto N-12	24 cl	117 mm
579704	Vaso Bajo N-60	28 cl	80 mm
575706	Vaso Bajo N-89	15 cl	62 mm

Ypsilon



Código	Descripción	Capacidad	Altura
125140	Vaso Alto Cooler	43,5 cl	175 mm
125030	Vaso Alto Long Drink	31,8 cl	160 mm
157120	Vaso Alto Long Drink	24 cl	140 mm
125060	Vaso Bajo Dof	35,5 cl	117 mm
125020	Vaso Bajo Pre Dinner	25,5 cl	107 mm
125040	Vaso Bajo After Dinner	15 cl	95 mm

Vega



Código	Descripción	Capacidad	Altura
340340	Vaso Alto Vega	32 cl	112 mm
430410	Vaso Medio Vega	22 cl	100 mm
430400	Vaso Bajo Vega	11 cl	80 mm

Endeavor



Libbey
GLASSWARE



Código	Descripción	Capacidad	Altura
15714	Vaso Alto Beverage	41,4 cl	168 mm
15712	Vaso Alto Beverage	35,5 cl	160 mm
15711	Vaso Alto Hi-Ball	29,6 cl	159 mm
15712	Vaso Bajo Old Fashioned	35,5 cl	105 mm
15710	Vaso Bajo Rocks	26,6 cl	98 mm
15709	Vaso Bajo Rocks	20,7 cl	92 mm
15733	Vaso Bajo Espresso	11 cl	76 mm



Diamond



Código	Descripción	Capacidad	Altura
350240	Vaso Cooler	47 cl	143,5 mm
302260	Vaso D.O.F.	38,5 cl	102,5 mm
350200	Vaso	30,5 cl	92,5 mm



Código

350250
302257
350210



Código

350260
302259
350220



Código

350270
302258
350230



Código	Descripción	Capacidad	Altura
V0244	Vaso Alto	47 cl	109 mm
V0245	Vaso Bajo	35 cl	99 mm

Syrah



Jerte



Código	Descripción	Capacidad	Altura
V1063	Vaso Alto Jerte	62 cl	144,5 mm
V1064	Vaso Bajo Jerte	49 cl	114 mm



Inverness

Libbey
GLASSWARE

Código	Descripción	Capacidad
V76215479	Vaso Alto	41,4 cl
V76215482	Vaso Bajo	37 cl
V76215485	Vaso Alto Hi-Ball	26,6 cl



Bravura



Código	Descripción	Capacidad	Altura
2212	Vaso Alto	49,5 cl	159 mm
2211	Vaso Bajo	36,2 cl	102 mm



Quartz

Durobor®

Código	Descripción	Capacidad	Altura
VV20534249	Vaso Alto Quartz	47 cl	16 cm
VV20534238	Vaso Bajo Quartz	33 cl	10,25 cm
20534230	Vaso Alto Quartz	30 cl	15,6 cm
20534225	Vaso Bajo Quartz	25 cl	9,5 cm





Código	Descripción	Capacidad	Altura
15244	Vaso Alto Beverage	41,4 cl	130 mm
15238	Vaso Alto Beverage	35,5 cl	123 mm
15236	Vaso Alto Hi-Ball	26,6 cl	118 mm
15239	Vaso Alto Hi-Ball	20,7 cl	115 mm
15243	Vaso Bajo Double Rocks	35,5 cl	100 mm
15232	Vaso Bajo Rocks	29,6 cl	96 mm
15241	Vaso Bajo Rocks	20,7 cl	79 mm

Durobor



Código	Descripción	Capacidad	Altura
V20534705	Vaso Chupito	5 cl	9,2 cm
V20534709	Vaso Bajo	9 cl	9,2 cm
V20534715	Vaso Bajo	15 cl	7 cm
V20534721	Vaso Bajo	20 cl	8,5 cm
V20534729	Vaso Bajo	29 cl	9,3 cm
V20534730	Vaso Tubo	30 cl	17,3 cm
V20534734	Vaso Tubo	34 cl	14 cm
VV20534731	Vaso Bajo	31 cl	9,8 cm
VV20534750	Vaso Bajo	50 cl	16 cm

Disco



Básicos



Código	Descripción	Capacidad	Altura
410610	Vaso Caña	47,6 cl	149 mm
410590	Vaso Caña	21,5 cl	104 mm
410580	Vaso Caña	17,7 cl	98 mm
410570	Vaso Caña	14,1 cl	109 mm
410620	Vaso Caña	8,9 cl	86 mm



Código	Descripción	Capacidad	Altura
V0055	Vaso Sidra	50 cl	121 mm
V0191	Vaso Pinta	36 cl	89 mm
V0203	Vaso Chiquito	23 cl	59 mm



Código	Descripción	Capacidad	Altura
V0034	Vaso Tubo	31 cl	164 mm
V0036	Vaso Tubo	27 cl	163 mm
V0043	Vaso Tubo	25 cl	150 mm





Belagua

Código	Descripción	Capacidad	Altura
V0384	Vaso Cerveza	56 cl	150 mm
V0398	Vaso Cerveza	47 cl	145 mm
V0386	Vaso Cerveza	33 cl	134 mm



Conil

Código	Descripción	Capacidad	Altura
V0225	Vaso Cerveza	56 cl	150 mm
V0224	Vaso Cerveza	47 cl	145 mm
V0223	Vaso Cerveza	33 cl	134 mm
V0222	Vaso Cerveza	28 cl	119 mm
V0221	Vaso Cerveza	22 cl	105 mm



Nonic

Código	Descripción	Capacidad	Altura
8804137	Vaso Cerveza	66 cl	159 mm
1031107	Vaso Cerveza	57 cl	152 mm
1031103	Vaso Cerveza	34 cl	127 mm
1031104	Vaso Cerveza	28 cl	115 mm



Executive

Código	Descripción	Capacidad	Altura
128550	Copa Cerveza	53 cl	205 mm
128540	Copa Cerveza	39 cl	186 mm
128530	Copa Cerveza	26 cl	167 mm



Harmonía

Código	Descripción	Capacidad	Altura
128550	Vaso Cerveza	53 cl	205 mm
128540	Vaso Cerveza	39 cl	186 mm
128530	Vaso Cerveza	26 cl	167 mm



Palladio

Código	Descripción	Capacidad	Altura
165280	Vaso Cerveza	54 cl	278 mm
165270	Vaso Cerveza	38 cl	238 mm
165260	Vaso Cerveza	28 cl	208 mm



Abadía

Código	Descripción	Capacidad	Altura
V0287	Copa Cerveza	42 cl	169 mm
V0286	Copa Cerveza	29 cl	150 mm



Dunkel

Código	Descripción	Capacidad	Altura
V0882	Vaso Cerveza	38 cl	182 mm
V0881	Vaso Cerveza	28 cl	165 mm



Toscana

Código	Descripción	Capacidad	Altura
V0294	Copa Cerveza	62 cl	157 mm
V0293	Copa Cerveza	41 cl	145 mm

Cerveza



Alemana

Código	Descripción	Capacidad	Altura
1051973	Copa Cerveza	44 cl	164 mm
1051972	Copa Cerveza	29 cl	157 mm



Cervoise

Código	Descripción	Capacidad	Altura
8824941	Copa Cerveza	62 cl	207 mm
8807131	Copa Cerveza	50 cl	191 mm
1031142	Copa Cerveza	38 cl	179 mm
1031141	Copa Cerveza	32 cl	166 mm
1031140	Copa Cerveza	26 cl	156 mm



Martigues

Código	Descripción	Capacidad	Altura
1031145	Vaso Cerveza	33 cl	150 mm
8818603	Vaso Cerveza	16 cl	123 mm



Malta

Código	Descripción	Capacidad	Altura
V0278	Copa Cerveza	56 cl	173 mm
V0273	Copa Cerveza	44 cl	157 mm
V0277	Copa Cerveza	33 cl	147 mm



G. Servicio

Código	Descripción	Capacidad	Altura
1051647	Copa Cerveza	60 cl	168 mm
1051646	Copa Cerveza	41 cl	147 mm



Príncipe

Código	Descripción	Capacidad	Altura
3163LCP48	Vaso Cerveza	48,5 cl	214 mm
3163LCP37	Vaso Cerveza	37 cl	204 mm
3163LCP30	Vaso Cerveza	30 cl	194 mm
3163LCP25	Vaso Cerveza	25 cl	172 mm



Baviera

Código	Descripción	Capacidad	Altura
133450	Jarra Cerveza	69 cl	197 mm
133440	Jarra Cerveza	50 cl	183 mm
133430	Jarra Cerveza	38 cl	168 mm
133420	Jarra Cerveza	26 cl	153 mm



Britania

Código	Descripción	Capacidad	Altura
1006067	Jarra Cerveza	56 cl	125 mm
1221101	Jarra Cerveza	28 cl	96 mm



Haworth

Código	Descripción	Capacidad	Altura
1221098	Jarra Cerveza	56 cl	130 mm
1121307	Jarra Cerveza	28 cl	103 mm



Pure

Código	Descripción	Capacidad	Altura
113755	Copa Cocktail	34 cl	180 mm



Mondial

Código	Descripción	Capacidad	Altura
185534	Copa Cocktail	24 cl	170 mm



Cóctel Saucer

Código	Descripción	Capacidad	Altura
115840	Copa Cocktail	25,9 cl	129 mm



Cabernet Cocktail

Código	Descripción	Capacidad	Altura
9222972	Copa Cocktail	21 cl	172 mm
8862449	Copa Cocktail	30 cl	188 mm



Margarita

Código	Descripción	Capacidad	Altura
8879921	Copa Cocktail	27 cl	106 mm
8862447	Copa Cocktail	44 cl	192 mm



Hurricane

Código	Descripción	Capacidad	Altura
8854584	Copa Cocktail	44 cl	208 mm
8810770	Copa Cocktail	25 cl	195 mm



Cóctel



Ypsilon Cocktail

Código	Descripción	Capacidad	Altura
122490	Copa Cocktail	24,5 cl	182 mm
149820	Copa Cocktail	12,5 cl	145 mm



Diamante

Código	Descripción	Capacidad	Altura
166131	Copa Cocktail	17 cl	151 mm



Z-STEM

Código	Descripción	Capacidad	Altura
37719	Copa Cocktail	15 cl	136 mm
37339	Copa Cocktail	22 cl	162 mm
37799	Copa Cocktail	27 cl	165 mm



Fountainware

Código	Descripción	Capacidad	Altura
5110	Vaso Cocktail	35 cl	190 mm



Cosmopolitan

Código	Descripción	Capacidad	Altura
400	Vaso Cocktail	24 cl	100 mm



Vintage

Código	Descripción	Capacidad	Altura
CO6587CV	Copa Cocktail	28 cl	168 mm



Classic

Código	Descripción	Capacidad	Altura
CO6587CP	Copa Cocktail	17 cl	170 mm
CO6587CP	Copa Cocktail	21 cl	183 mm



Xarel

Código	Descripción	Capacidad	Altura
V0201	Copa Cocktail	17 cl	221 mm



Chardonnay

Código	Descripción	Capacidad	Altura
V0403	Copa Cocktail	21 cl	221 mm



Subirats

Código	Descripción	Capacidad	Altura
V0317	Copa Cocktail	17 cl	194,5 mm

Coñac



Gran Coñac

Código	Descripción	Capacidad	Altura
9306757	Copa	77 cl	111 mm



Coñac Degustación

Código	Descripción	Capacidad	Altura
10070	Copa	41 cl	129 mm
10069	Copa	25 cl	112 mm
1031147	Copa	15 cl	96 mm



Coñac

Código	Descripción	Capacidad	Altura
V1964	Copa	30 cl	116 mm
V1962	Copa	25 cl	110 mm
V0821	Copa	20 cl	105 mm
V0743	Copa	15 cl	98 mm
V0187	Copa	10 cl	90,5 mm



Mondial

Código	Descripción	Capacidad	Altura
133948	Copa	51 cl	147 mm



Open Up

Código	Descripción	Capacidad	Altura
9261059	Copa	39 cl	132 mm



Pure

Código	Descripción	Capacidad	Altura
113756	Copa	62 cl	171 mm

Catavinos



Viticole

Código	Descripción	Capacidad	Altura
8819010	Copa	40 cl	200 mm
8842257	Copa	31 cl	175 mm
8837266	Copa	21,5 cl	155 mm
7742258	Copa	12 cl	131 mm



Arc

Código	Descripción	Capacidad	Altura
9238708	Copa	15,5 cl	151 mm



Catavinos

Código	Descripción	Capacidad	Altura
V0247	Copa	21 cl	155 mm
V0246	Copa	15,5 cl	151 mm

Frascas



Frasca Cuadrada

Código	Descripción	Capacidad	Altura
1012014	Frasca	2 L	200 mm
1012002	Frasca	1 L	175 mm
1012000	Frasca	0,5 L	155 mm
1012001	Frasca	0,25 L	131 mm



Misura

Código	Descripción	Capacidad	Altura
184179	Frasca	100 cl	262 mm
184169	Frasca	50 cl	235 mm
184159	Frasca	25 cl	190 mm



Ypsilon

Código	Descripción	Capacidad	Altura
125000	Frasca	108 cl	255 mm
125080	Frasca	55 cl	204 mm
128070	Frasca	29 cl	165 mm

Helado



Sorbet

Código	Descripción	Capacidad	Altura
8843121	Copa	38 cl	94 mm
1121308	Copa	21 cl	78 mm



Pepite

Código	Descripción	Capacidad	Altura
8853496	Copa	20 cl	60 mm



Glacé

Código	Descripción	Capacidad	Altura
1032173	Copa	21 cl	127 mm



Palmier

Código	Descripción	Capacidad	Altura
1121624	Copa	37 cl	201 mm
8858010	Copa	21 cl	101 mm



Jazzed

Código	Descripción	Capacidad	Altura
9126753	Copa	25 cl	92 mm



Catalina

Código	Descripción	Capacidad	Altura
3825	Copa	30 cl	100 mm



Deliss

Código	Descripción	Capacidad	Altura
V14033021	Copa	225 cc	140 mm



Dune

Código	Descripción	Capacidad	Altura
V14080020	Copa	270 cc	120 mm



Vértigo

Código	Descripción	Capacidad	Altura
V20579737	Vaso	370 cc	65 mm
V20579722	Vaso	220 cc	55 mm
V20579712	Vaso	120 cc	50 mm



Primavera

Código	Descripción	Capacidad	Altura
1121624	Copa	37 cl	201 mm



Jerba

Código	Descripción	Capacidad	Altura
134630	Copa	36 cl	140 mm



Ypsilon

Código	Descripción	Capacidad	Altura
340750	Copa	37 cl	90 mm



Acapulco

Código	Descripción	Capacidad	Altura
134010	Copa	30 cl	125 mm
134080	Copa	17,5 cl	105 mm



Gelatto

Código	Descripción	Capacidad	Altura
133990	Copa	28 cl	166 mm



Fortuna

Código	Descripción	Capacidad	Altura
191410	Copa	30 cl	180 mm



Combinados



Giona

Código	Descripción	Capacidad	Altura
CO6587	Copa	81 cl	210 mm
CO6587N	Copa	81 cl	210 mm



Barman - Gran Barman

Código	Descripción	Capacidad	Altura
CO69799B	Copa Barman	62 cl	185 mm
CO6799GB	Copa Gran Barman	62 cl	210 mm



Party

Código	Descripción	Capacidad	Altura
9126460	Copa	62 cl	200 mm



Havana

Código	Descripción	Capacidad	Altura
V0093	Copa	62 cl	195 mm
V0095	Copa	41 cl	170 mm



London

Código	Descripción	Capacidad	Altura
V0219	Copa	64 cl	221 mm



Peak

Código	Descripción	Capacidad	Altura
7144090	Copa	72 cl	225 mm



Vodka Plus

Código	Descripción	Capacidad	Altura
9225560	Copa	72 cl	255 mm



VB22299

Misket

Código	Descripción	Capacidad	Altura
VB22299	Copa	64,5 cl	200 mm
VA22299	Copa	64,5 cl	200 mm
VR22299	Copa	64,5 cl	200 mm
W22299	Copa	64,5 cl	200 mm
VX22299	Copa	64,5 cl	200 mm
VN22299	Copa	64,5 cl	200 mm



VA22299

VR22299

VV22299



VX22299

VN22299



Irish Coffee

Código	Descripción	Capacidad	Altura
8811874	Copa	24 cl	139 mm



Oslo

Código	Descripción	Capacidad	Altura
121870	Taza Multiuso	32 cl	107 mm
121880	Taza Capuchino	22 cl	96 mm
121890	Taza Café	10 cl	62 mm



Ypsilon

Código	Descripción	Capacidad	Altura
340340	Taza Té	32 cl	112 mm
340330	Taza Capuchino	22 cl	100 mm
340320	Taza Café	11 cl	80 mm



Carajillo

Código	Descripción	Capacidad	Altura
1051677	Vaso	11 cl	67 mm



Aroma

Código	Descripción	Capacidad	Altura
9231511	Taza	22 cl	85 mm
9231360	Taza	8 cl	64 mm



Barista

Código	Descripción	Capacidad	Altura
V205879512	Vaso	120 cc	8,5 cm
V205879522	Vaso	220 cc	13,65 cm



Bombón

Código	Descripción	Capacidad	Altura
121890	Vaso	13 cl	77 mm



Colombia

Código	Descripción	Capacidad	Altura
V0285	Vaso	18 cl	84,4 mm
V0292	Vaso	13 cl	77 mm
V0284	Vaso	11 cl	70 mm



Saturn

Código	Descripción	Capacidad	Altura
B803001	Mug borosilicato	29 cl	11 cm



Venus

Código	Descripción	Capacidad	Altura
B803006	Taza Capuchino borosilicato	20 cl	100 mm
B803007	Taza Café borosilicato	8 cl	65 mm



Jarras



Pichet

Código	Descripción	Capacidad	Altura
9230214	Jarra	130 cl	199 mm
9230215	Jarra	50 cl	153 mm



Arc

Código	Descripción	Capacidad	Altura
9227254	Jarra	130 cl	217 mm
9227255	Jarra	100 cl	202 mm
9227258	Jarra	50 cl	146 mm



Sangría

Código	Descripción	Capacidad	Altura
1013006	Jarra	175 cl	220 mm
1013001	Jarra	150 cl	200 mm
1013002	Jarra	125 cl	190 mm
1013003	Jarra	100 cl	180 mm



Bistrot

Código	Descripción	Capacidad	Altura
146160	Jarra	115 cl	186 mm
146150	Jarra	60 cl	145 mm
146140	Jarra	30 cl	115 mm



Exclusiv

Código	Descripción	Capacidad	Altura
85154/85	Jarra	1,5 L	213 mm



Decantadores



Pure

Código	Descripción	Capacidad	Altura
113745	Decantador	75 cl	271 mm



Clásico

Código	Descripción	Capacidad	Altura
110727	Decantador	75 cl	230 mm



Electra

Código	Descripción	Capacidad	Altura
192347	Decantador	161 cl	211 mm



Open Up

Código	Descripción	Capacidad	Altura
9276653	Decantador	1,4 L	314 mm



Intuito

Código	Descripción	Capacidad	Altura
9203075	Decantador	1,75 L	238 mm



Chupito / Licor



Riserva Grappa

Código	Descripción	Capacidad	Altura
166181	Copa	8,1 cl	163 mm



Amaro

Código	Descripción	Capacidad	Altura
V20590907	Copa licor	70 cc	153 mm

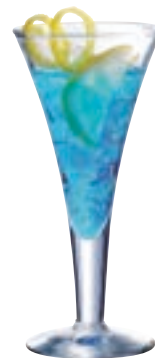

Royal

Código	Descripción	Capacidad	Altura
V205191516	Copa licor	60 cc	13,05 cm



Dublino

Código	Descripción	Capacidad	Altura
168169	Vaso chupito	3,4 cl	70 mm
169249	Vaso chupito	5,7 cl	90 mm



Chupito

Código	Descripción	Capacidad	Altura
V0187	Vaso chupito	4 cl	47 mm



Disco

Código	Descripción	Capacidad	Altura
20534705	Vaso chupito	5 cl	67 mm



Fiore Schnaps

Código	Descripción	Capacidad	Altura
129090	Vaso chupito	5,5 cl	145 mm



Islande

Código	Descripción	Capacidad	Altura
1031151	Vaso chupito	6 cl	105 mm



Pisa

Código	Descripción	Capacidad	Altura
V11006520	Vaso chupito	5 cl	57 mm



Granity

Código	Descripción	Capacidad	Altura
8804755	Vaso chupito	4,5 cl	57 mm



Conic

Código	Descripción	Capacidad	Altura
V11109522	Vaso chupito	55 cc	70 mm



Limoncino

Código	Descripción	Capacidad	Altura
128940	Vaso chupito	6 cl	115 mm

Ensaladeras



Apilable

Código	Descripción	Capacidad	Tamaño
8810011	Ensaladera	3,5 cl	6 cm
8810018	Ensaladera	7,5 cl	7 cm
8810040	Ensaladera	15 cl	9 cm
8810019	Ensaladera	24 cl	10 cm
8810000	Ensaladera	38 cl	12 cm
8810003	Ensaladera	62 cl	14 cm
8810027	Ensaladera	110 cl	17 cm
1121974	Ensaladera	180 cl	20 cm
1121975	Ensaladera	390 cl	23 cm
1121976	Ensaladera	430 cl	26 cm
1221148	Ensaladera	600 cl	29 cm



Mr. Chef

Código	Descripción	Capacidad	Tamaño
500000	Ensaladera	8 cl	9 cm
500010	Ensaladera	18 cl	11 cm
500020	Ensaladera	36 cl	14 cm
500030	Ensaladera	75 cl	17 cm
500040	Ensaladera	160 cl	22 cm
500050	Ensaladera	256 cl	26 cm
500060	Ensaladera	396 cl	30 cm



Practica

Código	Descripción	Tamaño
V14065120	Bowl	10 cm
V14065220	Bowl	12 cm
V14065320	Bowl	14 cm
V14065520	Bowl	18 cm
V14065431	Bowl	23 cm
V14065631	Bowl	25 cm

Ming Cristal

Código	Descripción	Tamaño
B3174	Bowl	20x20x8 cm
B3175	Bowl	14x14x7 cm
B3176	Bowl	10x10x6 cm
B3177	Bowl	8x8x4,5 cm



Apilable

Código	Descripción	Altura
1221102	Cenicero	85 mm
9231320	Cenicero	107 mm
8841471	Cenicero	145 mm



Apilable Negro

Código	Descripción	Altura
1221099	Cenicero	85 mm
1221116	Cenicero	107 mm
8841473	Cenicero	145 mm



Apilable Opal

Código	Descripción	Altura
8851254	Cenicero	85 mm
1221118	Cenicero	107 mm



Ceniceros

Bicos





VISTA ALEGRE

 1824

Código	Descripción	Capacidad	Altura
49000000	Copa Agua	28 cl	170 mm
49000062	Copa Vino	21 cl	153 mm
49000070	Copa Vino	14 cl	127 mm
49000078	Copa Licor	5,5 cl	101 mm
49000086	Copa Flauta	11 cl	190 mm



CUBERTERÍA

Cutlery • Couverts • Posate • Besteck



Guía de tamaños



Cuidados de la cubertería

- Eliminar los restos de comida lo antes posible antes de proceder al lavado.
- No utilizar estropajos metálicos o sintéticos para evitar el rayado de la cubertería.
- No utilice detergentes excesivamente abrasivos.
- No utilizar productos de limpieza con base ácida, ni agua con exceso de cloro.
- Una vez efectuado el lavado a mano o en el lavavajillas, es muy importante secar cuidadosamente los cubiertos con un paño suave.
- Al introducir los cubiertos en el lavavajillas, le recomendamos que los cuchillos se pongan verticalmente con las hojas hacia arriba.
- Controlar que la toma de tierra del lavavajillas funcione correctamente. Un mal funcionamiento de la misma puede provocar descargas que dañen la cubertería.



X-LO

- ✓ 3,5 mm
- ✓ Pulido Espejo
- ✓ Inox 18/10

Referencia	Descripción	←→ mm	Box
3090-1	Tenedor Mesa	220	12
3090-2	Cuchara Mesa	220	12
3090-5	Cuchillo Mesa	244	12
3090-45	Cuchillo Chuletero	244	12
3090-15	Cuhara Postre	193	12
3090-14	Tenedor Postre	193	12
3090-6	Cuchillo Postre	219	12
3090-3	Cuchara café	144	12
3090-26	Cuchara moka	110	12
3090-4	Tenedor lunch	141,5	12
3090-40	Cuchillo Mantequero	165	12
3090-16	Tenedor Pescado	182,5	12
3090-17	Pala de Pescado	208,5	12

eternum 
created 1924





Baguette

- √ 3 mm
- √ Pulido Espejo
- √ Inox 18/10

Referencia	Descripción	←→ mm	Box
42001	Cuchara Mesa	205	12
42002	Tenedor Mesa	205	12
42003	Cuchillo Mesa MB	240	12
42033	Cuchillo Chuletero	240	12
42004	Cuchara Postre	185	12
42005	Tenedor Postre	185	12
42006	Cuchillo Postre MB	216	12
42007	Cuchara Café	145	12
42009	Tenedor Lunch	145	12
42027	Cuchillo Lunch MB	178	12
42008	Cuchara Moka	115	12
42012	Pala Pescado	200	12
42013	Tenedor Pescado	195	12

Hoterali@



Verdi

- ✓ 3 mm
- ✓ Pulido Espejo
- ✓ Inox 18/10



Referencia	Descripción	←→ mm	Box
42601	Cuchara Mesa	203	12
42602	Tenedor Mesa	203	12
42603	Cuchillo Mesa MB	225	12
42633	Cuchillo Chuletero	225	12
42604	Cuchara Postre	186	12
42605	Tenedor Postre	186	12
42606	Cuchillo Postre MB	202	12
42607	Cuchara Café	150	12
42609	Tenedor Lunch	156	12
42608	Cuchara Moka	118	12
42612	Pala Pescado	204	12
42613	Tenedor Pescado	185	12

Hoterali@





City

- ✓ 3 mm
- ✓ Pulido Espejo
- ✓ Inox 18/10

Referencia	Descripción	<—> mm	Box
120001	Cuchara Mesa	210	12
120002	Tenedor Mesa	215	12
120003	Cuchillo Mesa MB	230	12
120004	Cuchara Postre	180	12
120005	Tenedor Postre	180	12
120006	Cuchillo Postre MB	200	12
120007	Cuchara café	135	12
120008	Cuchara moka	116	12
120012	Tenedor Lunch	155	12
120015	Tenedor Pescado	200	12
120016	Pala Pescado	207	12

Hoterali@



Daniela

- ✓ 3 mm
- ✓ Pulido Espejo
- ✓ Inox 18/10

Referencia	Descripción	<—> mm	Box
111001	Cuchara Mesa	202	12
111002	Tenedor Mesa	202	12
111003	Cuchillo Mesa MB	220	12
111004	Cuchara Postre	179	12
111005	Tenedor Postre	178	12
111006	Cuchillo Postre MB	192	12
111007	Cuchara Café	133	12
111012	Tenedor Lunch	153	12
111008	Cuchara Moka	116	12
111015	Tenedor Pescado	201	12
111016	Pala Pescado	207	12



Evento

- ✓ 4 mm
- ✓ Pulido Espejo
- ✓ Inox 18/10

Referencia	Descripción	←→ mm	Box
1001201	Cuchara Mesa	203	12
1001202	Tenedor Mesa	201	12
1001203	Cuchillo Mesa MB	230	12
1001237	Cuchillo Chuletero	225	12
1001204	Cuchara Postre	171	12
1001205	Tenedor Postre	171	12
1001206	Cuchillo Postre MB	206	12
1001207	Cuchara Café	134	12
1001212	Tenedor Lunch	155	12
1001208	Cucharita Moka	117	12
1001216	Pala Pescado	204	12
1001215	Tenedor Pescado	202	12



comas
EVERYDAY CUTLERY

Hotel

- ✓ 1,5 mm
- ✓ Acabado vibrado
- ✓ Inox 18%

Referencia	Descripción	←→ mm	Box
0014	Cuchara Mesa	195	12
0015	Tenedor Mesa	197	12
0013	Cuchillo Mesa	214	12
2454	Cuchillo Chuletero	225	12
0019	Cuchara Postre	186	12
0020	Tenedor Postre	178	12
0018	Cuchillo Postre	190	12
0023	Cuchara Café	140	12
0024	Cuchara Moka	110	12
0022	Tenedor Lunch	150	12
0021	Cuchillo Lunch	165	12



Mahé

- ✓ 5 mm
- ✓ Pulido Espejo
- ✓ Inox 18/10

Referencia	Descripción	←→ mm	Box
1810-1	Tenedor Mesa	214	12
1810-2	Cuchara Mesa	214	12
1810-5	Cuchillo Mesa MB	237	12
1810-5V	Cuchillo Mesa Vertical	235	12
1810-15	Cuchara Postre	188	12
1810-14	Tenedor Postre	188	12
1810-6	Cuchillo Postre MB	215	12
1810-6V	Cuchillo Postre Vertical	213	12
1810-3	Cuchara Café	140	12
1810-26	Cuchara Moka	110	12
1810-4	Tenedor Lunch	155	12
1810-40	Cuchillo Mantequero	172	12
1810-16	Tenedor Pescado	184	12
1810-17	Pala Pescado	204	12

eternum 
created 1924





X-15

- ✓ 10 mm
- ✓ Pulido Espejo
- ✓ Inox 18/10

Referencia	Descripción	←→ mm	Box
1860-1	Tenedor Mesa	218	12
1860-2	Cuchara Mesa	215	12
1860-5	Cuchillo Mesa MB	242	12
1860-45	Cuchillo Chuletero	243	12
1860-15	Cuchara Postre	191	12
1860-14	Tenedor Postre	193	12
1860-6	Cuchillo Postre MB	216	12
1860-26	Cuchara Café	143	12
1860-26	Cuchara Moka	110	12
1860-4	Tenedor Lunch	144	12
1860-40	Cuchillo Mantequero	162	12
1860-16	Tenedor Pescado	192	12
1860-17	Pala Pescado	206	12

eternum 
created 1924





London

- ✓ 2,5 mm
- ✓ Pulido Espejo
- ✓ Inox 18/10

Referencia	Descripción	←→ mm	Box
4335	Cuchara Mesa	205	12
4336	Tenedor Mesa	205	12
4362	Cuchillo Mesa	240	12
5952	Cuchillo Chuletero	228	12
5374	Cuchara Postre	185	12
5375	Tenedor Postre	185	12
5012	Cuchillo Postre	217	12
5437	Cuchara Café	137	12
5439	Tenedor Lunch	145	12
5438	Cuchara Moka	115	12
5373	Tenedor Pescado	195	12
5372	Pala Pescado	200	12

comas
EVERYDAY CUTLERY

North

- ✓ 3 mm
- ✓ Pulido Espejo
- ✓ Inox 18/10



Referencia	Descripción	←→ mm	Box
4536	Cuchara Mesa	205	12
4537	Tenedor Mesa	205	12
4535	Cuchillo Mesa	230	12
4402	Cuchillo Chuletero	228	12
5378	Cuchara Postre	185	12
5379	Tenedor Postre	185	12
4538	Cuchillo Postre	212	12
3948	Cuchara Café	135	12
5566	Tenedor Lunch	145	12
5015	Cuchillo Lunch	178	12
3949	Cuchara Moka	115	12
5377	Tenedor Pescado	195	12
5376	Pala Pescado	200	12



Mia

- √ 3 mm
- √ Pulido Espejo
- √ Inox 18/10

Referencia	Descripción	←→ mm	Box
2710	Cuchara Mesa	207	12
2711	Tenedor Mesa	203	12
2774	Cuchillo Mesa	229	12
2712	Cuchara Postre	190	12
2713	Tenedor Postre	190	12
5826	Cuchillo Postre	200	12
2715	Cuchara Café	136	12
2714	Tenedor Lunch	136	12
2716	Cuchara Moka	109	12
2734	Pala Pescado	215	12

comas
EVERYDAY CUTLERY



Madrid

- √ 3 mm
- √ Pulido Espejo
- √ Inox 18%

Referencia	Descripción	←→ mm	Box
1340	Cuchara Mesa	210	12
1341	Tenedor Mesa	205	12
2775	Cuchillo Mesa	221	12
1339	Cuchillo Chuletero	220	12
1595	Cuchara Postre	183	12
6117	Tenedor Postre	185	12
6115	Cuchillo Postre	204	12
1342	Cuchara Café	140	12
9655	Tenedor Lunch	140	12
9654	Cuchara Moka	110	12
9653	Tenedor Pescado	185	12
6114	Pala Pescado	200	12



Estasi

- ✓ 4 mm
- ✓ Pulido Espejo
- ✓ Inox 18/10

Referencia	Descripción	←→ mm	Box
997801	Cuchara Mesa	208	12
997802	Tenedor Mesa	208	12
997803	Cuchillo Mesa MB	236	12
997804	Cuchara Postre	183	12
997805	Tenedor Postre	183	12
997806	Cuchillo Postre MB	205	12
997807	Cuchara Café	142	12
997812	Tenedor Lunch	144	12
997808	Cucharita Moka	112	12
997815	Tenedor Pescado	208	12
997816	Pala Pescado	193	12



Gold

Referencia	Descripción	←→ mm	Box
0997801VO	Cuchara Mesa	208	12
0997802VO	Tenedor Mesa	208	12
0997803VO	Cuchillo Mesa MB	236	12
0997804VO	Cuchara Postre	183	12
0997805VO	Tenedor Postre	183	12
0997806VO	Cuchillo Postre MB	205	12
0997807VO	Cuchara Café	142	12
0997812VO	Tenedor Lunch	144	12
0997808VO	Cucharita Moka	112	12
0997815VO	Tenedor Pescado	208	12
0997816VO	Pala Pescado	193	12



Black

Referencia	Descripción	←→ mm	Box
0997801VN	Cuchara Mesa	208	12
0997802VN	Tenedor Mesa	208	12
0997803VN	Cuchillo Mesa MB	236	12
0997804VN	Cuchara Postre	183	12
0997805VN	Tenedor Postre	183	12
0997806VN	Cuchillo Postre MB	205	12
0997807VN	Cuchara Café	142	12
0997812VN	Tenedor Lunch	144	12
0997808VN	Cucharita Moka	112	12
0997815VN	Tenedor Pescado	208	12
0997816VN	Pala Pescado	193	12



Bronze

Referencia	Descripción	←→ mm	Box
0997801VR	Cuchara Mesa	208	12
0997802VR	Tenedor Mesa	208	12
0997803VR	Cuchillo Mesa MB	236	12
0997804VR	Cuchara Postre	183	12
0997805VR	Tenedor Postre	183	12
0997806VR	Cuchillo Postre MB	205	12
0997807VR	Cuchara Café	142	12
0997812VR	Tenedor Lunch	144	12
0997808VR	Cucharita Moka	112	12
0997815VR	Tenedor Pescado	208	12
0997816VR	Pala Pescado	193	12



Baguette

- ✓ 3 mm
- ✓ Envejecido
- ✓ Inox 18/10



Vittoriale

- ✓ 3 mm
- ✓ Envejecido
- ✓ Inox 18/10



Settecento

- ✓ 3 mm
- ✓ Envejecido
- ✓ Inox 18/10

PINTINOX

Baguette

Referencia	Descripción	←→ mm	Box
08320001	Cuchara Mesa	206	12
08320002	Tenedor Mesa	206	12
08320003	Cuchillo Mesa MH	241	12
08320004	Cuchara Postre	178	12
08320005	Tenedor Postre	185	12
08320006	Cuchillo Postre MH	220	12
08320007	Cuchara Café	146	12
08320008	Cuchara Moka	118	12
08320017	Tenedor Lunch	151	12

Vittoriale

Referencia	Descripción	←→ mm	Box
16420001	Cuchara Mesa	209	12
16420002	Tenedor Mesa	209	12
16420003	Cuchillo Mesa MH	240	12
16420004	Cuchara Postre	188	12
16420005	Tenedor Postre	188	12
16420006	Cuchillo Postre MH	215	12
16420007	Cuchara Café	145	12
16420008	Cuchara Moka	120	12
16420017	Tenedor Lunch	159	12

Settecento

Referencia	Descripción	←→ mm	Box
20540001	Cuchara Mesa	201	12
20540002	Tenedor Mesa	201	12
20540003	Cuchillo Mesa MH	227	12
20540004	Cuchara Postre	171	12
20540005	Tenedor Postre	171	12
20540006	Cuchillo Postre MH	202	12
20540007	Cuchara Café	146	12
20540008	Cuchara Moka	118	12
20540017	Tenedor Lunch	148	12



Danubio

- ✓ 2,5 mm
- ✓ Pulido Espejo
- ✓ Inox 18/10

Referencia	Descripción	←→ mm	Box
5000010	Cuchara Mesa	208	12
5000020	Tenedor Mesa	208	12
5000035	Cuchillo Mesa MB	220	12
5000040	Cuchara Postre	193	12
5000050	Tenedor Postre	191	12
5000095	Cuchillo Postre MB	186	12
5000100	Cuchara Café	150	12
5000070	Cuchara Moka	122	12
5000800	Tenedor Lunch	155	12
5000130	Tenedor Pescado	193	12
5000120	Pala Pescado	217	12



Lidia

- ✓ 2 mm
- ✓ Pulido Espejo
- ✓ Inox 18/10

Referencia	Descripción	←→ mm	Box
6100010	Cuchara Mesa	202	12
6100020	Tenedor Mesa	200	12
6100030	Cuchillo Mesa MB	211	12
6100100	Cuchara Café	145	12
6100620	Cuchara Moka	107	12
6100625	Tenedor Lunch	145	12
6100035	Cuchillo Lunch MB	174	12



Iris

- ✓ 3,5 mm
- ✓ Pulido Espejo
- ✓ Inox 18/10

Referencia	Descripción	<—> mm	Box
9400010	Cuchara Mesa	217	12
9400020	Tenedor Mesa	216	12
9400035	Cuchillo Mesa MB	230	12
9400625	Cuchillo Chuletero MB	228	12
9400040	Cuchara Postre	186	12
9400050	Tenedor Postre	188	12
9400095	Cuchillo Postre MB	187	12
9400100	Cuchara Café	151	12
9400070	Cuchara Moka	131	12
9400080	Tenedor Lunch	153	12
9400130	Tenedor Pescado	188	12
9400120	Pala Pescado	199	12

DALIA



Royal

- ✓ 2,5 mm
- ✓ Pulido Espejo
- ✓ Inox 18/10

Referencia	Descripción	<—> mm	Box
1725010	Cuchara Mesa	199	12
1725020	Tenedor Mesa	195	12
1725035	Cuchillo Mesa MB	206	12
1725040	Cuchara Postre	188	12
1725050	Tenedor Postre	182	12
1725095	Cuchillo Postre MB	172	12
1725100	Cuchara Café	142	12
1725070	Cuchara Moka	118	12
1725080	Tenedor Lunch	147	12
1725130	Tenedor Pescado	193	12
1725120	Pala Pescado	210	12



Laura

- √ 2,5 mm
- √ Pulido Espejo
- √ Inox 18/10

Referencia	Descripción	<—> mm	Box
9600010	Cuchara Mesa	214	12
9600020	Tenedor Mesa	208	12
9600035	Cuchillo Mesa MB	214	12
9600625	Cuchillo Chuletero MB	218	12
9600040	Cuchara Postre	190	12
9600050	Tenedor Postre	188	12
9600095	Cuchillo Postre MB	185	12
9600100	Cuchara Café	156	12
9600070	Cuchara Moka	121	12
9600080	Tenedor Lunch	153	12
9600130	Tenedor Pescado	190	12
9600120	Pala Pescado	212	12



Teresa

- √ 2,5 mm
- √ Pulido Espejo
- √ Inox 18/10



Referencia	Descripción	<—> mm	Box
8100010	Cuchara Mesa	198	12
8100020	Tenedor Mesa	200	12
8100035	Cuchillo Mesa MB	215	12
8100625	Cuchillo Chuletero MB	221	12
8100040	Cuchara Postre	175	12
8100050	Tenedor Postre	174	12
8100095	Cuchillo Postre MB	185	12
8100100	Cuchara Café	145	12
8100070	Cuchara Moka	109	12
8100080	Tenedor Lunch	145	12
8100130	Tenedor Pescado	175	12
8100120	Pala Pescado	198	12

Aranjuez

√ 3 mm
√ Pulido Espejo
√ Inox 18/10



Referencia	Descripción	<—> mm	Box
163010	Cuchara Mesa	207	12
163020	Tenedor Mesa	204	12
163030	Cuchillo Mesa	245	12
163040	Cuchara Postre	172	12
163050	Tenedor Postre	171	12
163060	Cuchillo Postre	196	12
163100	Cuchara Café	135	12
163070	Cuchara Moka	101	12
163080	Tenedor Lunch	135	12
163090	Cuchillo Lunch	178	12
163130	Tenedor Pescado	181	12
163120	Pala Pescado	198	12



Inglete

√ 3 mm
√ Pulido Espejo
√ Inox 18/10



Referencia	Descripción	<—> mm	Box
107010	Cuchara Mesa	213	12
107020	Tenedor Mesa	217	12
107030	Cuchillo Mesa	252	12
107040	Cuchara Postre	179	12
107050	Tenedor Postre	182	12
107060	Cuchillo Postre	210	12
107100	Cuchara Café	142	12
107070	Cuchara Moka	94	12
107080	Tenedor Lunch	144	12
107090	Cuchillo Lunch	185	12
107130	Tenedor Pescado	178	12
107120	Pala Pescado	211	12



Olivia

- ✓ 3 mm
- ✓ Pulido Espejo
- ✓ Inox 18/10

Referencia	Descripción	<—> mm	Box
49001	Cuchara Mesa	230	12
49002	Tenedor Mesa	230	12
49003	Cuchillo Mesa MB	245	12
49004	Cuchara Postre	198	12
49005	Tenedor Postre	197	12
49006	Cuchillo Postre MB	214	12
49007	Cuchara Café	165	12
49017	Tenedor Lunch	197	12
49008	Cucharita Moka	110	12
49028	Tenedor Pescado	197	12
49029	Pala Pescado	218	12

PINTINOX



Ellade

- ✓ 3 mm
- ✓ Pulido Espejo
- ✓ Inox 18/10

Referencia	Descripción	<—> mm	Box
79001	Cuchara Mesa	212	12
79002	Tenedor Mesa	211	12
79003	Cuchillo Mesa MB	240	12
79004	Cuchara Postre	187	12
79005	Tenedor Postre	184	12
79006	Cuchillo Postre MB	217	12
79007	Cuchara Café	155	12
79017	Tenedor Lunch	164	12
79008	Cucharita Moka	125	12
79028	Tenedor Pescado	186	12
79029	Pala Pescado	206	12



Wave

- ✓ 3 mm
- ✓ Pulido Espejo
- ✓ Inox 18%

Referencia	Descripción	<—> mm	Box
2610001	Cuchara Mesa	210	12
2610002	Tenedor Mesa	210	12
2610003	Cuchillo Mesa	226	12
2610005	Tenedor Postre	185	12
2610006	Cuchillo Postre	203	12
2610007	Cuchara Café	147	12
2610008	Cucharita Moka	110	12

PINTINOX



Swing

- ✓ 3 mm
- ✓ Pulido Espejo
- ✓ Inox 18/10

Referencia	Descripción	<—> mm	Box
880001	Cuchara Mesa	208	12
880002	Tenedor Mesa	209	12
880003	Cuchillo Mesa	225	12
880004	Cuchara Postre	187	12
880005	Tenedor Postre	187	12
880006	Cuchillo Postre	205	12
880007	Cuchara Café	146	12
880017	Tenedor Lunch	154	12
880008	Cucharita Moka	118	12
880028	Tenedor Pescado	181	12
880029	Pala Pescado	198	12



Sonate

- ✓ 5 mm
- ✓ Pulido Espejo
- ✓ Inox 18/10

Referencia	Descripción	<—> mm	Box
977-1	Tenedor Mesa	199	12
977-2	Cuchara Mesa	198	12
977-5	Cuchillo Mesa	219	12
977-45	Cuchillo Chuletero	228	12
977-15	Cuchara Postre	175	12
977-14	Tenedor Postre	181	12
977-6	Cuchillo Postre	191	12
977-3	Cuchara Café	143	12
977-26	Cuchara Moka	114	12
977-4	Tenedor Lunch	149	12
977-16	Tenedor Pescado	180	12
977-17	Pala Pescado	206	12

eternum 
created 1924



Rustic

- ✓ Forjado
- ✓ Pulido Espejo
- ✓ Inox 18/10



Referencia	Descripción	←→ mm	Box
8005-1	Tenedor Mesa	199	12
8005-2	Cuchara Mesa	198	12
8005-5	Cuchillo Mesa	225	12
8005-45	Cuchillo Chuletero	225	12
8005-3	Cuchara Café	142	12
8005-26	Cuchara Moka	112	12
8005-4	Tenedor Lunch	150	12

eternum 
created 1924





Pétale

- ✓ 5,5 mm
- ✓ Pulido Espejo
- ✓ Inox 18/10

Referencia	Descripción	<—> mm	Box
1880-1	Tenedor Mesa	215	12
1880-2	Cuchara Mesa	215	12
1880-5	Cuchillo Mesa	240	12
1880-15	Cuchara Postre	190	12
1880-14	Tenedor Postre	190	12
1880-6	Cuchillo Postre	215	12
1880-3	Cuchara Café	145	12
1880-26	Cuchara Moka	110	12
1880-4	Tenedor Lunch	145	12
1880-16	Tenedor Pescado	190	12
1880-17	Pala Pescado	210	12

eternum 
created 1924



Iris

- ✓ 3 mm
- ✓ Pulido Espejo
- ✓ Inox 18/10



Referencia	Descripción	<—> mm	Box
11090001	Cuchara Mesa	214	12
11090002	Tenedor Mesa	213	12
11090003	Cuchillo Mesa	226	12
11090004	Cuchara Postre	189	12
11090005	Tenedor Postre	188	12
11090007	Cuchara Café	150	12
11090008	Tenedor Lunch	162	12
11090009	Cuchillo Lunch/Postre	197	12
11090010	Pala Pescado	207	12
11090011	Tenedor Pescado	188	12
11090012	Cuchara Moka	118	12
11090043	Cuchillo Carne	226	12



Ébano

- ✓ 3 mm
- ✓ Pulido Espejo
- ✓ Inox 18/10



Referencia	Descripción	<—> mm	Box
11086001	Cuchara Mesa	204	12
11086002	Tenedor Mesa	205	12
11086003	Cuchillo Mesa	229	12
11086004	Cuchara Postre	185	12
11086005	Tenedor Postre	185	12
11086006	Cuchillo Postre	202	12
11086007	Cuchara Café	149	12
11086008	Tenedor Lunch	153	12
11086009	Cuchillo Lunch	188	12
11086010	Pala Pescado	205	12
11086011	Tenedor Pescado	185	12
11086012	Cuchara Moka	117	12
11086030	Pala mantequilla	170	12



Vanity

✓ 2 mm

✓ Pulido Espejo

✓ Inox

Referencia	Descripción	←→ mm	Box
11049001	Cuchara Mesa	207	12
11049002	Tenedor Mesa	206	12
11049003	Cuchillo Mesa	222	12
11049004	Cuchara Postre	184	12
11049005	Tenedor Postre	184	12
11049007	Cuchara Café	145	12
11049008	Tenedor Lunch	160	12
11049009	Cuchillo Lunch/Postre	195	12
11049010	Pala Pescado	204	12
11049011	Tenedor Pescado	184	12
11049012	Cuchara Moka	117	12



Silk

✓ 2 mm

✓ Pulido Espejo

✓ Inox



Referencia	Descripción	←→ mm	Box
12068001	Cuchara Mesa	203	12
12068002	Tenedor Mesa	201	12
12068003	Cuchillo Mesa	215	12
12068004	Cuchara Postre	185	12
12068005	Tenedor Postre	183	12
12068006	Cuchillo Postre	202	12
12068007	Cuchara Café	143	12
12068008	Tenedor Lunch	148	12
12068009	Cuchillo Lunch	182	12
12068010	Pala Pescado	203	12
12068011	Tenedor Pescado	183	12
12068012	Cuchara Moka	115	12
12068043	Cuchillo Carne	222	12

Chuleteros



Referencia	Descripción
371500	Cuchillo Chuletero M/Madera
371600	Tenedor Chuletero M/Madera



Referencia	Descripción
375500	Cuchillo Chuletero Inox Sierra
376500	Cuchillo Chuletero Inox Filo
7021400	Tenedor Chuletero Inox



Referencia	Descripción
375000	Cuchillo Chuletero Virola Latón
375100	Tenedor Chuletero Virola Latón



Referencia	Descripción
372500	Cuchillo Chuletero M/Madera
372600	Tenedor Chuletero M/Madera



Referencia	Descripción
372800	Cuchillo Chuletero M/PP Sierra
372600	Tenedor Chuletero M/PP Filo



Referencia	Descripción
0681	Cuchillo Chuletero Inox Satinado
42633	Cuchillo Chuletero Inox Verdi



Referencia	Descripción
373700	Cuchillo Chuletero M/Palisandro
373723	Cuchillo Chuletero M/Resina
373728	Cuchillo Chuletero M/Resina



Referencia	Descripción
076000Y	Cuchillo Chuletero Sierra



Referencia	Descripción
374610	Cuchillo Chuletero Macheta
374210	Tenedor Chuletero Macheta



Referencia	Descripción
3000	Cuchillo Chuletero Alps



Referencia	Descripción
3136	Cuchillo Chuletero K2 Natural
3137	Cuchillo Chuletero K2 Negro



Referencia	Descripción
741000EU	Cuchillo Chuletero Sierra
741000EY	Tenedor Chuletero Filo



Referencia	Descripción
374822	Cuchillo Chuletero M/POM Rojo
374722	Tenedor Chuletero M/POM Rojo
374823	Cuchillo Chuletero M/POM Azul
374723	Tenedor Chuletero M/POM Azul
374821	Cuchillo Chuletero M/POM Verde
374721	Tenedor Chuletero M/POM Verde
374825	Cuchillo Chuletero M/POM Amarillo
374725	Tenedor Chuletero M/POM Amarillo

CUCHILLERÍA

Knives • Couteaux • Coltelli • Messer



Clásica

HOJA: Acero inoxidable Forjado NITRUM®.
MANGO: Polioximetileno (POM).

ARCOS

Referencia	Descripción	<—> mm
1 255300	Cocinero	260
2 255200	Cocinero	230
3 255100	Cocinero	210
4 255500	Cocinero	160
5 256800	Jamoner	300
6 256700	Jamoner	250
7 256000	Filetear	210
8 255900	Filetear	160
9 256600	Santoku	180
10 256900	Santoku	140
11 256500	Deshuesar	160
12 256200	Deshuesar	140
13 256400	Pan	180
14 256300	Tenedor	160
15 255600	Tomatero	130
16 255800	Chuletero	120
17 255700	Puntilla	100



Kyoto

HOJA: Acero inoxidable Forjado NITRUM®.
MANGO: Polioximetileno (POM).

ARCOS

Referencia	Descripción	←→ mm
1 178400	Cocinero	240
2 178300	Cocinero	210
3 178600	Jamonero	250
4 178800	Santoku	185
5 178500	Deshuesar	145
6 178700	Pan	220
7 179000	Cocina Sierra	160
8 178900	Cocina	160
9 178200	Verduras	125
10 178000	Mondador	100



Riviera

HOJA: Acero inoxidable Forjado NITRUM®.
MANGO: Polioximetileno (POM).

ARCOS

Referencia	Descripción	<—> mm
233800	Cocinero	300
233700	Cocinero	250
233600	Cocinero	200
233400	Cocinero	150
231100	Jamonero	300
231000	Jamonero	250
233000	Filetear	200
232900	Filetear	170
233500	Santoku	180
233200	Santoku	140
231500	Deshuesar	130
231300	Pan	200
233300	Tenedor	180
232800	Queso	145
232000	Tomatero	130
230600	Cocinero	150
230500	Cocinero	130
230200	Mondador	100



Tango

HOJA: Acero inoxidable Forjado NITRUM®.
MANGO: Polipropileno.

ARCOS

Referencia	Descripción	←→ mm
1	Cocinero	200
2	Jamonero	240
3	Filetear	170
4	Santoku	180
5	Pan	200
6	Cocinero	160
7	Verduras	120
8	Mondador	100



Universal

HOJA: Acero inoxidable Forjado NITRUM®.
MANGO: Polioximetileno (POM).

ARCOS

Referencia	Descripción	<—> mm
280804	Cocinero	300
280704	Cocinero	250
1 280604	Cocinero	200
280504	Cocinero	175
280804	Cocinero	155
283304	Carnicero	300
2 283204	Carnicero	250
283104	Carnicero	200
282604	Deshuesar	160
3 282504	Deshuesar	130
282204	Panero	250
4 282104	Panero	200
5 284304	Pastelero	300
6 283904	Pastelero	250
7 281604	Queso	145
280304	Puntilla	120
8 280204	Puntilla	100
9 282004	Jamón P/redonda	290
10 284004	Salmón P/redonda	290
11 283804	Jamón Ancho	300
12 283704	Salmón Ancho	300
281904	Jamón Punta	280
13 281804	Jamón Punta	240
281901	Salmón Punta	280
14 281801	Salmón Punta	240
15 286400	Espátula	125x90
16 286500	Espátula	125x120
17 286600	Espátula Codo	160
286304	Espátula Pastelero	300
18 286204	Espátula Pastelero	250
286104	Espátula Pastelero	205



Universal

HOJA: Acero inoxidable Forjado NITRUM®.
MANGO: Polioximetileno (POM).

ARCOS

Referencia	Descripción	←→ mm
1	Macheta	180
2	Macheta	160
3	Macheta	280
4	Macheta	220
5	Cuchilla Filetear	280
6	Cuchilla Filetear	260
7	Cuchillo Carnicero	300
8	Cuchillo Carnicero	275
9	Pescadero Redondo	300
10	Pescadero Punta	320
11	Pescadero Punta	290
12	Queso 2 Mangos	400



2900

HOJA: Acero inoxidable Forjado NITRUM®.
MANGO: Inyectado Polipropileno.

Gracias al color del mango del cuchillo podemos saber para qué tipo de alimento se va a utilizar, permitiendo así un control higiénico-sanitario exhaustivo y el cumplimiento de las normas europeas sanitarias de control de la alimentación.



ARCOS

Referencia	Descripción	←→ mm	00	21	22	23	24	25	28	31
2923	Cocinero	300	x	x	x	x		x		
1 2922	Cocinero	250	x	x	x	x	x	x	x	
2921	Cocinero	200	x	x	x	x	x	x	x	x
2 2904	Puntilla	130	x	x	x	x		x		x
2938	Jamonero	400	x		x			x		
3 2935	Jamonero	350	x		x			x		
2934	Jamonero	300	x		x		x	x		
2988	Fiambre	410	x					x		
4 2987	Fiambre	360	x					x		
2957	Fiambre	300	x					x		
5 2914	Pan	200	x				x	x		x
6 2997	Espátula	125x120	x					x		
2996	Espátula	125x90	x					x		
2992	Espátula Pastelero	300	x				x	x		
7 2991	Espátula Pastelero	250	x				x	x		x
2990	Espátula Pastelero	200	x				x	x		



NUEVO COLOR ALÉRGENOS
Propuesta color fucsia para
facilitar la identificación de
los cuchillos a utilizar en las
preparaciones para personas
con algún tipo de alergia.



Referencia	Descripción	<—> mm	00	22	23	25
2964	Macheta	270	x	x		x
1 2963	Macheta	250	x	x		x
2962	Macheta	220	x	x		x
2983	Cuchilla 3 mm	280	x	x		x
2981	Cuchilla 3 mm	260	x	x		x
2 2982	Cuchilla 2 mm	280	x	x		x
2980	Cuchilla 2 mm	260	x	x	x	x
3 2924	Carnicero	350	x	x	x	x
4 2925	Pescadero	350	x	x	x	x
2971	Cuchilla Pescadero	320	x		x	x
5 2970	Cuchilla Pescadero	290	x		x	x
6 2969	Carnicero	300	x	x		x
7 2968	Pollero	275	x			x
8 2979	Golpe	255	x			x



Global

Los cuchillos GLOBAL están hechos con el más fino acero inoxidable. A la hora de confeccionar las hojas se utiliza el CROMOVA 18, siendo 18% el porcentaje de Cromo que hay en el acero. Este hecho le da una dureza suficiente al acero para que el cuchillo permanezca más tiempo afilado que la competencia, pero a su vez ésta no es excesiva para que no sea muy difícil de afilar.

El filo es de forma cóncava y no en forma de "V", ya que de esta forma se consigue que dure más tiempo afilado y también que el cuchillo se deslice mejor a través del alimento. Es importante resaltar que el afilado del cuchillo GLOBAL es artesanal.

Los cuchillos GLOBAL están templados al hielo y endurecidos con el proceso, "Rockwell", que somete la hoja a una temperatura de 56°C-58°C, lo que dota a los cuchillos de un filo cortante de más duración que el filo hecho con cualquier otro acero. Lo hace muy resistente a la herrumbre, a todo tipo de manchas y, en especial, a la corrosión.



Referencia	Descripción	<—> mm
G17	Cocinero	270
1 G16	Cocinero	240
G2	Cocinero	200
G19	Filetear flexible	270
2 G18	Filetear flexible	240
G20	Filetear flexible	210
3 G5	Vegetales	180
G56	Vegetales alveolado	180
4 G46	Santoku	180
G48	Santoku alveolado	180
5 G09	Pan	220
6 G10	Jamonero flexible	310
7 G14	Yanagi sashimi	300
G11	Yanagi sashimi	250
8 G7	Deba	180
9 G15	Tako sashimi	300
GS2110	Espatula	250
10 GS2108	Espatula	200
GS2106	Espatula	150
GS2104	Espatula	110
11 GS38	Puntilla	90



Classic

PEtec: ¡La nueva tecnología de WÜSTHOF para una agudeza superior!

Tecnología:

- El láser mide las hojas antes del afilado.
- Los ordenadores calculan de forma individual para cada hoja el ángulo de afilado exacto.
- Unos robots de precisión afilan las hojas en una piedra húmeda.
- Finalmente, los cuchillos reciben la pasada definitiva de pulido mediante una muela especial.

Ventajas:

- Capacidad de corte inicial extrema.
- Duración del filo extraordinariamente larga.
- Geometría del filo óptima en toda la longitud de la hoja.
- Calidad incomparable, reproducible y siempre del mismo nivel.



WÜSTHOF

Referencia	Descripción	<—> mm
1522087	Chef hoja ancha	360
1522086	Chef hoja ancha	320
1522082	Chef hoja ancha	260
1522080	Chef hoja ancha	200
1522078	Chef	320
1522075	Chef	260
1522074	Chef	230
1522073	Chef	200
0505105	Cocinero flexible	200
152035	Cocinero flexible	160
0542010	Jamonero largo	320
0509100	Jamonero P. redonda	260
1575067	Santoku	170
1575063	Santoku	140
1522027	Cuchillo trinchar	200
16580320	Tenedor trinchar	200
1522024	Puntilla	120
1522022	Puntilla	100
1522020	Puntilla	90



Shun Damasco

Los productos Kai tienen desde hace tiempo prestigio y culto en Japón, junto con un alto grado de reconocimiento internacional. Grandes chefs de los cinco continentes utilizan sus cuchillos, junto a los buenos aficionados a la cocina.

Fundada en Seki en 1908, la compañía lleva más de 100 años fabricando cuchillos de las más altas gamas, con la serie Shun en acero damasco, como protagonista.



Referencia	Descripción	<—> mm
1577207	Chef	250
1577205	Chef	200
1577203	Chef	150
1577201	Chef	105
1577104	Chef hoja estrecha	225
1577102	Chef hoja estrecha	180
1577195	Jamonero	300
1577661	Santoku	180
1577190	Cuchillo trinchar	200
1580025	Tenedor trinchar	200
1577000	Puntilla	85



Gen Series

La cerámica se encuentra cada vez más a menudo entre los utensilios de nuestra cocina. En el caso de los cuchillos, ha demostrado tener beneficios: Un filo inalterable, impermeabilidad a los colores, oxidaciones y una mejor higiene.

La cerámica es un material resistente que mantiene su capacidad de corte hasta diez veces más que el acero. Además, los cuchillos Kyocera no transfieren su sabor u olor a los alimentos, no se oxidan con los ácidos de las frutas y vegetales y evitan que estos se pongan negros al manipularlos.

Sin embargo, la dureza implica fragilidad. Es fundamental evitar los golpes contra superficies duras. Deben usarse sobre tablas de madera o de plástico y jamás para cortar huesos, espinas o alimentos congelados.



Referencia	Descripción	<—> mm
2681122	Chef blanco	200
1 2681124	Chef blanco	180
2681123	Chef blanco	160
2681122	Chef blanco	140
2 2681120	Usos varios blanco	110
3 2681109	Puntilla blanco	75
2681018	Chef negro	180
4 2681019	Chef negro	160
2681018	Chef negro	140
5 2681014	Usos varios negro	110
6 2681008	Puntilla negro	75



Tijeras



Soportes magnéticos



Código	(mm)
692700	500x45
692600	450x45
692500	300x45

Bolsas



Fundas protectoras

Código	(mm)
694000	80x22
694100	130x22
694200	200x32
694300	205x50
694400	265x50
694500	310x33



Código	(mm)	Capacidad
690200	460x275	4 Piezas
690400	500x510	8 Piezas
690500	730x510	12 Piezas
691400	520x920	17 Piezas

Polietileno



Consultar para otras medidas y colores.

Certificado ISO 9001-2008.
Inscripción registro sanitario.
Certificado Garantía Sanitaria.

Tablas Polietileno

Tamaño	20 mm	30 mm	40 mm	50 mm
300x200	322000	323000	424000	425000
400x200	422000	423000	424000	425000
500x300	532000	533000	534000	645000
600x400	442000	443000	444000	445000
400x400	442000	443000	444000	445000
500x500	552000	553000	554000	555000

Disponible en: 



Reparador Tablas
Cod. NPPR1
177x64x87 mm

Cuchilla repuesto NPPR01



Soporte Tablas

Código	(mm)
NC016	300x280x263; 6 Tablas
NC016-1	310x230x270; 5 Tablas

Guantes malla



Cod. 615000
210 mm
Talla XXS



Cod. 615100
230 mm
Talla XS



Cod. 615200
240 mm
Talla S



Cod. 615300
250 mm
Talla M



Cod. 615400
270 mm
Talla L

Corte y decoración



Referencia	Descripción
1	7201425 Vaciador Melón 25 mm Ø
	7201510 Vaciador Patata 10 mm Ø
	7201515 Vaciador Patata 15 mm Ø
2	7201518 Vaciador Patata 18 mm Ø
	7201522 Vaciador Patata 22 mm Ø
	7201525 Vaciador Patata 25 mm Ø
	7201530 Vaciador Patata 30 mm Ø
3	7201210 Decorador Fruta
4	7200516 Descorazonador Manzana 16 mm
	7200620 Descorazonador Manzana 20 mm
5	7201800 Vaciador Melón Oval
6	7203010 Pelador Uvas
7	7204005 Pelador Patatas
8	7209003 Rallador Limón
9	7209504 Acanalador Rectangular
10	7209704 Acanalador Redondo
11	7207507 Ruleta Lisa 7 cm Ø
12	7207007 Ruleta Rizada 7 cm Ø
13	7209312 Cortador Juliana
14	7211911 Espátula Queso
	7251912 Espátula Lisa 12 cm
15	7250915 Espátula Lisa 15 cm
	7250120 Espátula Lisa 20 cm
	7252309 Espátula Codo 9 cm
16	7251312 Espátula Codo 12 cm
	7250220 Espátula Codo 20 cm

Afilado



Chaira redonda

Código	(mm)
278100	230x10 Ø
278200	250x13 Ø
278510	300x13 Ø



Chaira Oval

Código	(mm)
279010	300x20 Ø



Chaira Oval Diamante

Código	(mm)
279200	280x17 Ø



Afilador Manual Minosharp
Cod. 220/GB



Afilador eléctrico Waring
Cod. WKS800E
318x146x108 mm
2 piedras afilar + 1 rueda pulir

COCINA

Kitchen • Cuisine • Cucina • Küche



Batería profesional



Chef Classic

- Toda la pieza está fabricada en Acero Inoxidable 18/10
- Fondo Termodifusor (Inox 18/10 - Aluminio - Inox)
- Espesor 0,7 - 1,2 mm.
- Apta para todos los tipos de cocina (incluida indicción y horno)
- Acabado mate interior y exterior.
- Máxima garantía en cuanto a resitencia, durabilidad e higiene.



Cacerola

Ref.	Ø (cm)	h (cm)	L
50016	16	8,0	1,60
50020	20	9,0	2,80
50024	24	9,5	4,25
50028	28	11,0	6,75
50032	32	12,5	10,00
50036	36	14,0	14,20
50040	40	15,5	19,40
50045	45	17,0	27,00
50050	50	20,0	38,20
50060*	60	25,0	70,00

* NO inducción · NOT induction



Cacerola alta

Ref.	Ø (cm)	h (cm)	L
50017	16	11,0	2,20
50021	20	13,0	4,00
50025	24	14,0	6,75
50029	28	17,5	10,00
50033	32	18,0	14,40
50037	36	21,5	21,80
50044	40	24,5	30,70
50046	45	27,5	43,70
50051	50	30,0	58,80
50061*	60	35,0	98,00

* NO inducción · NOT induction



Olla

Ref.	Ø (cm)	h (cm)	L
50116	16	16,0	3,20
50120	20	20,2	6,20
50124	24	24,0	10,50
50128	28	28,0	17,20
50132	32	32,0	25,70
50136	36	36,0	36,60
50140	40	40,0	50,00
50145	45	45,0	68,30
50150	50	50,0	98,00
50160*	60	50,0	141,00

* NO inducción · NOT induction



Olla baja

Ref.	Ø (cm)	h (cm)	L
50119	20	15,0	4,70
50123	24	20,0	9,00
50127	28	22,5	13,50
50131	32	26,0	20,80
50135	36	29,0	29,50
50139	40	32,0	40,00



Tapa

Ref.	Ø (cm)
------	--------

50916	16
50918	18
50920	20
50924	24
50928	28
50932	32
50936	36
50940	40
50945	45
50950	50
50960	60



Paellera

Ref.	Ø (cm)	h (cm)	L
------	--------	--------	---

50624	24	6,0	2,70
50628	28	6,0	3,60
50632	32	6,0	5,00
50636	36	7,0	7,10
50640	40	8,0	10,00
50645	45	8,5	13,50
50650	50	9,0	17,60
50660*	60	9,0	25,40

* NO inducción · NOT induction



Cazo Recto

Ref.	Ø (cm)	h (cm)	L
------	--------	--------	---

50212	12	7,0	0,75
50214	14	7,5	1,10
50216	16	8,0	1,60
50218	18	9,0	2,20
50220	20	9,0	2,80
50224	24	9,5	4,25
50228	28	11,0	6,75



Cazo Recto Alto

Ref.	Ø (cm)	h (cm)	L
------	--------	--------	---

50217	16	11,0	2,10
50219	18	12,0	3,00
50221	20	13,0	4,00
50225	24	14,0	6,30
50229	28	17,5	10,20



Cazo Francés

Ref.	Ø (cm)	h (cm)	L
------	--------	--------	---

50225N	24	12,0	5,50
50229N	28	14,0	8,50



Cazo Cónico

Ref.	Ø (cm)	h (cm)	L
------	--------	--------	---

51216	16	6,0	1,00
51218	18	6,0	1,20
51220	20	6,5	1,60
51222	24	7,0	2,10
51224	28	7,5	2,70



Sautex

Ref.	Ø (cm)	h (cm)	L
------	--------	--------	---

50625	24	6,5	2,70
50629	28	7,0	4,00
50633	32	8,5	4,70
50637	36	10,0	7,00



Baño María

Ref.	Ø (cm)	h (cm)	L
------	--------	--------	---

50717	16	16,0	3,20
50721	20	20,0	6,20

Batería cocina

pujadas
A VOLLRATH COMPANY

PROFESSIONAL COOKWARE

Inox-Pro

- Cuerpo Acero Inoxidable 18/10
- Asas soldadas de varilla matizada.
- Espesor 0,7 - 1,2 mm.
- Soldadura artesanal.
- Fondo Sandwich.



Cacerola

Ref.	Ø (cm)	h (cm)	L
207.116	16	7,5	1,50
207.018	18	8,0	2,00
207.020	20	8,0	2,50
207.024	24	9,5	4,30
207.028	28	11,0	6,70
207.030	30	12,0	8,40
207.032	32	12,5	10,00
207.035	35	14,0	13,60
207.040	40	15,5	19,50
207.045	45	17,0	27,00
207.050	50	20,0	39,00
207.060	60	23,0	65,00



Olla

Ref.	Ø (cm)	h (cm)	L
208.016	16	16,0	3,00
208.018	18	18,0	4,50
208.020	20	20,0	6,20
208.024	24	24,0	10,00
208.028	28	28,0	16,50
208.030	30	30,0	21,20
208.032	32	32,0	24,00
208.035	35	35,0	33,60
208.040	40	40,0	50,00
208.045	45	45,0	72,00
208.050	50	50,0	98,00
208.060	60	55,0	155,00



Cacerola alta

Ref.	Ø (cm)	h (cm)	L
206.016	16	11,0	2,10
206.016	18	12,0	3,00
206.016	20	13,0	4,00
206.016	24	14,0	6,30
206.016	28	17,5	10,20
206.016	30	18,0	12,70
206.016	32	19,0	15,20
206.016	35	21,0	20,20
206.016	40	25,0	31,40
206.016	45	28,0	44,50
206.016	50	30,0	59,00
206.016	60	35,0	99,00



Paellera

Ref.	Ø (cm)	h (cm)	L
215.020	20	6,0	1,90
215.024	24	6,0	2,70
215.028	28	6,0	3,70
215.030	30	6,0	4,30
215.032	32	6,0	4,70
215.035	35	7,0	6,70
215.040	40	8,0	10,00
215.045	45	8,5	12,00
215.050	50	9,0	17,50
215.060	60	10,0	28,00



Cazo Francés

Ref.	Ø (cm)	h (cm)	L
200.012	12	7,0	0,70
200.014	14	7,0	1,00
200.016	16	7,5	1,50
200.018	18	9,0	2,30
200.020	20	10,0	3,10
200.022	22	11,0	4,20
200.024	24	12,0	5,40
200.028	28	14,0	8,60



Cazo Recto

Ref.	Ø (cm)	h (cm)	L
201.016	16	7,5	1,50
201.018	18	8,0	2,00
201.020	20	8,0	2,50
201.024	24	9,5	4,30
201.028	28	11,0	6,70
201.032*	32	12,5	10,00

*Con contraasa



Cazo Recto Alto

Ref.	Ø (cm)	h (cm)	L
202.016	16	11,0	2,10
202.018	18	12,0	3,00
202.020	20	13,0	4,00
202.024	24	14,0	6,30
202.028	28	17,5	10,20
202.032*	32	19,0	15,20

*Con contraasa



Cazo Cónico

Ref.	Ø (cm)	h (cm)	L
214.016	16	6,0	1,00
214.018	18	6,0	1,20
214.020	20	6,5	1,60
214.022	22	7,0	2,10
214.024	24	7,5	2,70



Cazo con Picos

Ref.	Ø (cm)	h (cm)	L
200.116	16	7,5	1,50
200.120	20	10,0	3,10



Cazo Bombado

Ref.	Ø (cm)	h (cm)	L
200.320	20	7,5	1,80
200.324	24	8,5	3,00



Pote

Ref.	Ø (cm)	h (cm)	L
210.016	16	16,0	3,00
210.018	18	18,0	4,50
210.020	20	20,0	6,20



Baño María

Ref.	Ø (cm)	h (cm)	L
203.016	16	16,0	3,00
203.018	18	18,0	4,50
203.020	20	20,0	6,20
203.024	24	24,0	10,00



Sautex

Ref.	Ø (cm)	h (cm)	L
204.020	20	6,0	1,90
204.024	24	6,0	2,70
204.028	28	6,0	3,70
204.030	30	6,0	4,30
204.032	32	6,0	4,70
204.035	35	7,0	6,70
204.040*	40	8,0	10,00

*Con contraasa

Ollas presión



Chef

- Acero Inoxidable 18/10

Ref.	Ø (cm)	h (cm)	L
------	--------	--------	---

71815	28	25,0	15,00
71821	28	33,0	20,00



Robust

- Aluminio 99,55% pureza
- Triple sistema de seguridad

Ref.	Ø (cm)	h (cm)	L
------	--------	--------	---

20830	42	31,0	30,00
20840	42	39,0	40,00
20850	42	46,0	50,00



Pro-classic

- Uso profesional
- Aluminio 99,55% pureza

Ref.	Ø (cm)	h (cm)	L
------	--------	--------	---

20518	32	23,0	18,00
20522	34	23,0	22,00



Pro-classic alta

- Uso profesional
- Aluminio 99,55% pureza

Ref.	Ø (cm)	h (cm)	L
------	--------	--------	---

20615	27	27,5	15,00
20618	27	32,5	18,00



Classic

- Uso doméstico
- Acero inoxidable 18/10

Ref.	Ø (cm)	h (cm)	L
------	--------	--------	---

71874	22	11,5	4,00
71876	22	17,0	6,00
71878	24	19,0	8,00
71871	24	23,0	10,00
71872	26	23,0	12,00
71875	26	29,0	15,00



Rustideras



Rustidera Chef-inox

• Acero Inoxidable 18/10

Ref.	cm	h (cm)
50540	40x30	8,0
50550	50x40	8,0
50560	60x45	8,0
50570	70x45	9,5



Rustidera s/asas

• Acero Inoxidable 18/10

Ref.	cm	h (cm)
62530	30x21	5,5
62535	35x26	5,5
62540	40x31	6,0



Rustidera a/abatible

• Acero Inoxidable 18% Cr

Ref.	cm	h (cm)
61530	30x22	5,0
61535	35x26	5,3
61540	40x28	5,6
61545	45x32	7,5
61550	50x36	8,5



Rustidera Honda a/abatible

• Acero Inoxidable 18/10

Ref.	cm	h (cm)
62530A	30x22	7,5
62535A	35x26	7,8
62540A	40x28	8,5
62545A	45x32	9,0



Rustidera Robust

• Aluminio antiadherente

Ref.	cm	h (cm)
23540A	40x30	6,0
23550A	50x35	8,0



Rustidera a/abatible

• Aluminio

Ref.	cm	h (cm)	e (cm)	L
20540A	40x30	6,2	2,5	7,45
20545A	45x32	6,2	2,5	10,40
20550A	50x35	7,0	3,0	12,60
20555A	55x37	7,7	3,0	16,30
20560A	60x40	7,7	3,0	18,95
20565A	65x43	7,9	3,0	24,30
20570A	70x45	9,0	3,0	28,65



Rustidera a/fija

• Aluminio

Ref.	cm	h (cm)	e (cm)	L
20540F	40x30	6,2	2,5	7,45
20545F	45x32	6,2	2,5	10,40
20550F	50x35	7,0	3,0	12,60
20555F	55x37	7,7	3,0	16,30
20560F	60x40	7,7	3,0	18,95
20565F	65x43	7,9	3,0	24,30
20570F	70x45	9,0	3,0	28,65

Utensilios



Escurridera cónica

Ref.	Ø (cm)	h (cm)	L
50829	28	17,0	13,20
50833	32	20,0	14,50
50837	36	23,0	16,00
50841	40	26,0	18,00
50846	45	29,0	20,00
50851	50	33,0	22,00



Escurridera c/base

Ref.	Ø (cm)	h (cm)	L
50332	32	18,0	9,50
50336	36	19,0	12,00
50340	40	21,0	14,50



Escurrefritos

Ref.	cm	h (cm)
50541	40x29	8,0
50551	50x39	8,0
50561	60x39	8,0

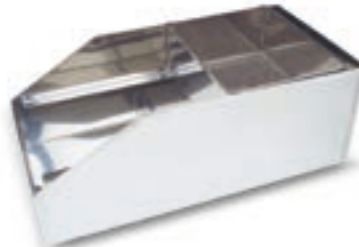

Harinero

Ref.	cm
50438	18x37x26,5
50450	18x50x26,5



Colador 4 sectores

• Combinables con cacerola alta de 36,40 cm.

Ref.	Ø (cm)	h (cm)
50335	36	23,0
50339	40	26,0



Utensilios



Hervidor pescado

Ref.	(cm)	h (cm)	L
50440	40x19	11	10,05
50445	50x17	11	13,80
50460	60x19	11	20,80



Vaporera

Ref.	Ø (cm)	h (cm)
50428	28	11,0
50432	32	12,5



Cuscusera

Ref.	Ø (cm)	h (cm)	L
50437	30x16,5	28	15,0
50441	40x22	32	22,0

Batidores



Batidor universal

Ref.	L (cm)
2610.25	26,5
2610.30	32,0
2610.35	37,0
2610.40	41,5
2610.45	46,5
2610.50	50,0



Batidor fiberglass

Ref.	L (cm)
61624	25
61629	30
61634	35
61639	40
61644	45
61649	50



Batidor extra

Ref.	L (cm)
61626	25
61631	30
61636	35
61641	40
61646	45
61651	50



Batidor mini

Ref.	L (cm)
61615	15
61620	20



Batidor gigante

Ref.	L (cm)
61610	100
61612	129

Utensilios cocina



Cacillo

Ref.	Ø (cm)	h (cm)	L
60306	6,50	33,50	0,07
60308	8,00	33,50	0,12
60309	9,00	44,50	0,20
60310	10,00	44,50	0,25
60312	12,00	49,00	0,50
60314	14,00	54,00	0,75
60316	16,00	55,50	1,00



Cuchara lisa

Ref.	Ø (cm)	L (cm)
60507	7,50	47



Espátula lisa

Ref.	(cm)	L (cm)
61410	10	49,50
61412	12	50,50



Espumadera

Ref.	Ø (cm)	L (cm)
60408	8	34,00
60410	10	48,00
60412	12	49,50
60414	14	55,00
60416	16	57,00



Cuchara oblicua

Ref.	Ø (cm)	ml
60509	7,5x34	70



Cacillo perforado

Ref.	Ø (cm)	h (cm)	L
61308	8	39	0,12
61310	10	46	0,25
61312	12	47	0,50



Cuchara perforada

Ref.	Ø (cm)	L (cm)
60508	7,50	47



Espátula perforada

Ref.	(cm)	L (cm)
61411	10	49,50
61413	12	50,50



Paleta pescado

Ref.	(cm)	L (cm)
62988	20,5x8	37,00



Tenedor

Ref.	Puntas	L (cm)	cm
60002	2	57	7x7
60003	3	57	7x7

Espumadera alambre

Ref.	Ø (cm)	L (cm)
60409	10	47,50
60411	12	50,00
60413	14	51,00
60415	16	53,00
60417	18	62,00
60419	20	62,00
60423	24	73,00
60427	28	73,00



Rasera alambre

Ref.	Ø (cm)	L (cm)
67410	10	37,00
67412	12	44,00
67415	15	55,50
67417	17	56,00
67420	20	58,00

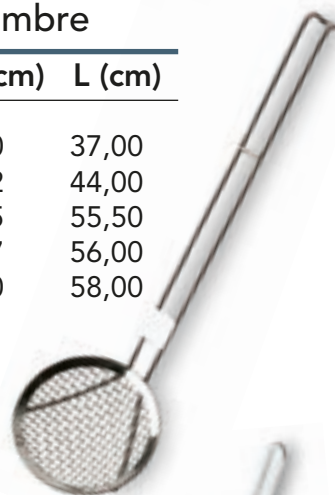

Espumadera alambre estaño

Ref.	Ø (cm)	L (cm)
63514	14	54,00
63516	16	56,50
63518	18	56,50
63520	20	67,00
63524	24	70,50
63528	28	76,00



Tenedor estaño

Ref.	L (cm)	cm
64040	40,50	7x7
64060	60,50	7,5x9

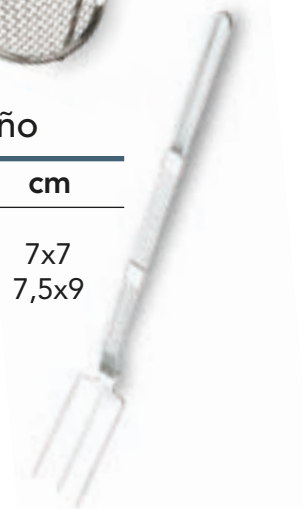

Super Mono Block



Cacillo

Ref.	ml	L (cm)
62603	100	31,00



Espumadera

Ref.	L (cm)
62604	36,50



Tenedor

Ref.	L (cm)
62605	33,50



Espátula

Ref.	L (cm)
62606	33,50



Cuchara lisa

Ref.	L (cm)
62607	32,00



Cuchara perforada

Ref.	L (cm)
62608	32,00



Cacillo salsa

Ref.	ml	L (cm)
62609	30	31,00



Cacillo spaghetti

Ref.	L (cm)
62811	31,00

Batería aluminio fundido

Efficient

- Apto para lavavajillas.
- Apto para todo tipo de fuegos.
- Recubrimiento antiadherente Teflón® Platinum Plus.
- Tecnología Eco+: 100% libre PFOA.
- Asas silicóna desmontables.
- 6 mm. espesor.



Cacerola alta

Ref.	Ø (cm)	L
270320	20	3,0
270324	24	4,0
270328	28	5,7
270332	32	8,3
270336	36	11,2



Cacerola baja

Ref.	Ø (cm)	L
270516	16	0,8
270520	20	1,5
270524	24	2,3
270528	28	3,1
270530	30	4,1
270532	32	5,0
270536	36	7,1
270540	40	9,0
270545*	45	12,0
274345**	45	



*Sin Tapa

** Tapa Inox Ø45



Olla alta

Ref.	Ø (cm)	L
273903	20	4,1
273905	24	6,8
273907	28	11,1



Wok

Ref.	Ø (cm)	L
272024	24	3,0
272028	28	4,2
272032	32	5,5

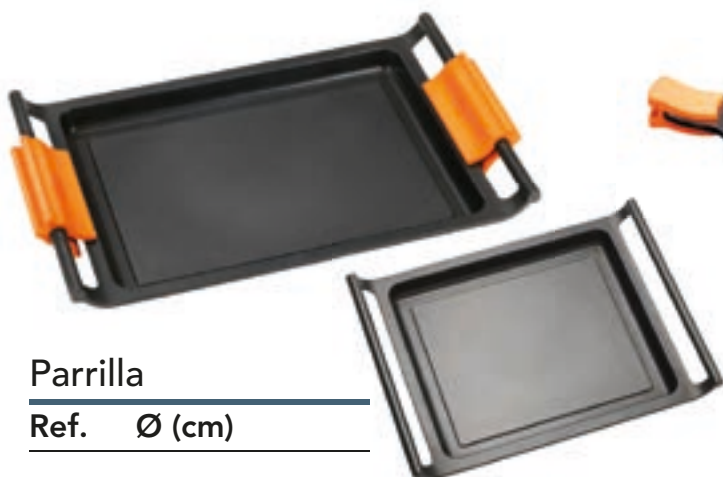

Parrilla

Ref.	Ø (cm)
------	--------

271535*	35
---------	----

271545*	45
---------	----

* Las asas de silicona se venden por separado.

Asas de silicona parrilla (blister 2 und.)

Ref.	Ø (cm)
------	--------

284008	35-45
--------	-------



Paellera

Ref.	Ø (cm)	raciones
------	--------	----------

271632	32	5
--------	----	---

271636	36	7
--------	----	---

271640	40	9
--------	----	---



Cazo

Ref.	Ø (cm)
------	--------

273816	16
--------	----



Crepera

Ref.	Ø (cm)
------	--------

272526	26
--------	----



Sartén

Ref.	Ø (cm)
------	--------

271216	16
--------	----

271218	18
--------	----

271220	20
--------	----

271222	22
--------	----

271224	24
--------	----

271226	26
--------	----

271228	28
--------	----

271230	30
--------	----



Grill

Ref.	Ø (cm)
------	--------

271322	22
--------	----

271328	28
--------	----



Grill c/rayas

Ref.	Ø (cm)
------	--------

271422	22
--------	----

271428	28
--------	----

Batería cobre

- Apto para lavavajillas.
- Apto para todo tipo de fuegos.
- Recubrimiento antiadherente Teflón® Platinum Plus.
- Tecnología Eco+: 100% libre PFOA.
- Asas silicona desmontables.
- 6 mm. espesor.



de BUYER
 DEPUIS 1830



Cacerola baja

Ref.	Ø (cm)	h (cm)	L
6446.20	20	6	1,8
6446.24	24	7	3,2
6446.28	28	9	5,5



Cacerola

Ref.	Ø (cm)	h (cm)	L
6447.16	16	8	1,6
6447.20	20	10	3,5
6447.24	24	11,5	5,2



Sartén

Ref.	Ø (cm)	L
6449.12	12	2
6449.16	16	3
6449.20	20	4
6449.24	24	4

Sartén c/asas

Ref.	Ø (cm)	L
6450.20	20	4
6450.24	24	4
6450.28	28	4



Sarten oval

Ref.	Ø (cm)	h (cm)	L
6451.32	23	32	4,5
6451.36	26,2	36	4,5



Cazo recto

Ref.	Ø (cm)	h (cm)	L
6445.10	10	5,5	
6445.12	12	6	0,8
6445.14	14	7	1
6445.16	16	8,5	1,6
6445.18	18	9	2,5
6445.20	20	10	3,5



Cazo recto bajo

Ref.	Ø (cm)	h (cm)	L
6448.16	16	5	1
6448.20	20	6	1,8
6448.24	24	6,5	3



Work

Ref.	Ø (cm)	L
6432.32	30,9	8,5



Perol esférico

Ref.	Ø (cm)	h (cm)	L
6580.26N	26	13	4,5
6580.30N	30	15	7
6580.40N	40	20	16,7
6581.30N	30	15	7



Perol plano

Ref.	Ø (cm)	h (cm)	L
6200.38N	38	15	9
6202.40N	40	14,4	11

Mini utensilios



Cacillo para salsa con tapadera

Ref.	Ø (cm)	h (cm)	L
6453.09	9	4,5	0,3



Cacillo para salsa

Ref.	Ø (cm)	h (cm)	L
6445.09	9	4,5	0,3
6445.10	10	5,5	



Mini cacerola con monturas

Ref.	Ø (cm)	h (cm)	L
6447.10	10	5,5	



Mini sartén

Ref.	Ø (cm)	h (cm)	L
6445.09	9,3	3,2	

Sartenes



Ergos

Ref.	Ø (cm)	h (cm)
------	--------	--------

120.018	18	4,0
120.020	20	4,0
120.022	22	4,5
120.024	24	4,5
120.026	26	5,0
120.028	28	5,0
120.032	32	5,5
120.036	36	6,0
120.040	40	6,5

Aluminio 4/5 mm.
Antiadherente



Ergos Excalibur

Ref.	Ø (cm)	h (cm)
------	--------	--------

220.018	18	3,5
220.020	20	3,8
220.022	22	4,2
220.024	24	4,6
220.026	26	5,0
220.028	28	5,5
220.032	32	6,0
220.036	36	6,0
220.040	40	6,5

Acero inoxidable 18/10
Antiadherente
Fondo sandwich



Chef tricapa

Ref.	Ø (cm)	h (cm)
------	--------	--------

21618	18	3,8
21620	20	4,0
21622	22	4,0
21624	24	4,5
21626	26	4,5
21628	28	4,5
21632	32	4,7
21636	36	5,5
21640	40	5,5

Aluminio 2,5/4 mm.
Antiadherente 3 capas



Choc

Ref.	Ø (cm)	h (cm)
------	--------	--------

8180.20	20	3
8180.24	24	3,5
8180.26	26	3,7
8180.28	28	3,8
8180.30	30	4,5
8180.32	32	4,5
8180.36	36	4,7
8180.40	40	5,3

Aluminio 4/5 mm.
Antiadherente 5 capas





Aire

Ref.	Ø (cm)	h (cm)
------	--------	--------

4641.25	20	4,0
4649.25	22	4,0
4642.25	24	4,5
4643.25	26	4,5
4644.25	28	4,5
4645.25	30	5,0

Marca: Yalira
Fundición aluminio
Antiadherente



Dynamic

Ref.	Ø (cm)	h (cm)
------	--------	--------

23420	20	4,0
23424	24	4,5
23428	28	4,5
23432	32	4,7
23436	36	5,5

Fundición aluminio
Antiadherente



Mineral

Ref.	Ø (cm)	h (cm)
------	--------	--------

5610.20	20	3,3
5610.24	24	3,5
5610.26	26	4
5610.28	28	4
5610.32	32	4,5
5610.36	36	5

Hierro 2,5/3 mm
Protección anti-oxidación



Lyonesa

Ref.	Ø (cm)	h (cm)
------	--------	--------

5020.14	14	3,3
5020.16	16	3,3
5020.18	18	3,6
5020.20	20	4
5020.22	22	4
5020.24	24	4,5
5020.26	26	4,5
5020.28	28	4,7
5020.30	30	5
5020.32	32	5,5
5020.36	36	6
5020.40	40	6,5
5020.45	45	7,5

Hierro azul 1/1,5 mm
Rápida difusión de calor



Paellas



Paella pulida

Ref.	Ø (cm)	raciones	asas
0124	24	1	2
0126	26	2	2
0128	28	3	2
0130	30	4	2
0132	32	5	2
0134	34	6	2
0136	36	7	2
0138	38	8	2
0140	40	9	2
0142	42	10	2
0146	46	12	2
0150	50	13	2
0155	55	16	2
0160	60	20	2
0165	65	25	2
0170	70	30	2
0180	80	40	4
0190	90	50	4
01100	100	85	4
01115	115	120	4
01130	130	200	6



Paella esmaltada

Ref.	Ø (cm)	raciones	asas
0224	24	1	2
0226	26	2	2
0228	28	3	2
0230	30	4	2
0232	32	5	2
0234	34	6	2
0236	36	7	2
0238	38	8	2
0240	40	9	2
0242	42	10	2
0246	46	12	2
0250	50	13	2
0255	55	16	2
0260	60	20	2
0265	65	25	2
0270	70	30	2
0280	80	40	4
0290	90	50	4
02100	100	85	4
02115	115	120	4



Sarten esmaltada honda

Ref.	Ø (cm)	asas
0622	22	2
0624	24	2
0626	26	2
0628	28	2
0630	30	2
0632	32	2
0634	34	2
0636	36	2
0638	38	2
0640	40	2
0645	45	2
0650	50	2
0655	55	2
0660	60	2
0665	65	2



Tripode

Ref.	unidades
1800	5

Paellas

Ref.	Ø (cm)
0210	10
0212	12
0215	15
0220	20

Sartenes

Ref.	Ø (cm)
0614	14
0616	16
0618	18
0620	20

Paellero gas

Ref.	Ø (cm)	fuegos	paella (cm)
1320	20	1	26/36
1430	30	1	36/42
2635	35	2	20/50
2540	40	2	26/60
1550	50	2	36/70
1660	60	3	26/80
1770	70	3	36/90



Coladores



Cazo colador Marca: Lacor
Acero inoxidable 18/10

Ref.	Ø (cm)	h (cm)	L
50320	20	12	3,5
50324	24	14	6,5
50328	28	15	9,3



Colador doble malla

Ref.	Ø (cm)	<small>Marca: Lacor Acero estañado</small>
61316	16	
61318	18	
61320	20	
61323	23	
61326	26	
61330	30	
61335	35	



Colador 1/2 bola

Ref.	Ø (cm)	<small>Marca: Lacor Acero inoxidable 18/10</small>
62680	8	
62610	10	
62612	12	
62614	14	
62616	16	
62618	18	
62620	20	
62623	23	



Colador chino

Ref.	Ø (cm)	<small>Marca: Lacor Acero inoxidable 18/10</small>
60311	10	
60313	12	
60315	14	
60317	16	
60318	18	
60320	20	
60322	22	
60324	24	
60326	26	



Colador chino malla

Ref.	Ø (cm)	<small>Marca: Lacor Acero inoxidable 18/10</small>
60319	18	
60321	20	
60323	22	
60325	24	



Colador fuerte

Ref.	Ø (cm)	<small>Marca: Inoxibar Acero inoxidable 18/10</small>
53514	14	
53516	16	
53518	18	
53520	20	
53523	23	
53525	25	
53531	31	
53536	36	



Mano chino

Ref.	cm	U.E.	<small>Marca: Lacor Polietileno</small>
60400	28x6,5	6	



Soporte chino

Ref.	cm	<small>Marca: Tellier Acero inoxidable</small>
N3020	18x28	

Pasapures



Pasapures profesional

Ref. Ø (cm) Marca: Lacor

60026	26
60031	32



Pasapures

Ref. Ø (cm) Marca: Tellier

N3002X	20
N3004X	24



Pasapures eléctrico

Ref. cm Potencia W Marca: Tellier

EXT5T100	37x108	600
----------	--------	-----



Pasapures industrial

Ref. Ø (mm) Marca: Tellier

X500		sin rejilla
X510	1	con rejilla
X515	1,5	con rejilla
X520	2	con rejilla
X530	3	con rejilla
X540	4	con rejilla



Rejillas pasapures industrial

Ref. Ø (mm) Marca: Tellier

X510	1
X515	1,5
X520	2
X530	3
X540	4

Morteros



Mortero granito

Ref. Ø (cm) Marca: Lacor

60512	12x8
60514	14x10
60516	16x12



Mortero granito

Ref. Ø (cm) Marca: Lacor

60517	12x8
60518	11x11

Dosificadores



Mini kwik

Marca: De Buyer

Ref.	Ø (cm)	h (cm)	L
------	--------	--------	---

3353.00	15	15,5	0,8
---------	----	------	-----



Kwik pro

Marca: De Buyer

Ref.	Ø (cm)	h (cm)	L
------	--------	--------	---

3354.00	19	18	1,9
3354.02	19	18	1,9
3354.10	17,5	16,5	1,5
3354.12	17,5	16,5	1,5



Kwik maxi

Marca: De Buyer

Ref.	Ø (cm)	h (cm)	L
------	--------	--------	---

3354.50	20	38	3,3
---------	----	----	-----



Embudo

Ref.	cm	U.E.
------	----	------

Marca: Lacor

62512	12	1
62514	14	1
62516	16	1
62518	18	1
62521	20	1
62524	24	1



Dosificador

Ref.	Lts
------	-----

Marca: Lacor

67000	2
-------	---



Dosificador: Le tube

Ref.	L (cm)	L
------	--------	---

Marca: De Buyer

3358.00	38,4	0,75
---------	------	------



Ralladores

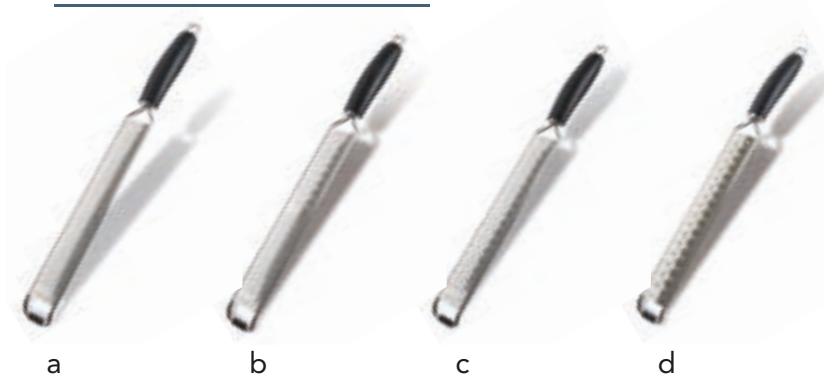

Ref.	descripción	medida
322104	Fino	39,5x3,5
322101	Dual	39,5x3,5
322102	Doble navaja	39,5x3,5
322103	Medio	39,5x3,5



Ref.	descripción	medida
322204	Fino	31,5x7,3
322201	Tiras largas	31,5x7,3
322202	Doble navaja	31,5x7,3
322203	Grueso	31,5x7,3



Rallador 4 caras

Ref. cm

328023 10,5x8x23,3



Rallador nuez moscada

Ref. cm

391000



Sopletes



Ref. descripción

786600 Cabezal soplete profesional
727060 Recambio gas profesional



Ref. descripción

704500 Soplete gourmet
727020 Recambio gas butano

Pinzas



Marca: Lacor

Pinza Multiusos Luxe

Ref. \longleftrightarrow mm

62334 250



Marca: Lacor

Pinza Repostería

Ref. \longleftrightarrow mm

62317 200

Pinza Multiusos

Marca: APS

Ref. descripción \longleftrightarrow mm

00685	Pinza ensalada	250
00688	Pinza multiusos	250
00687	Pinza Pan	250
00686	Pinza bollería	250



Marca: Lacor

Pinza Servir

Ref. \longleftrightarrow mm

68009 240



Marca: Lacor

Pinza Pasta Luxe

Ref. \longleftrightarrow mm

62981 200



Marca: Lacor

Pinza Pan

Ref. \longleftrightarrow mm

62982 230



Marca: Lacor

Pinza Hielo

Ref. \longleftrightarrow mm

62306 185



Marca: Lacor

Pinza Repostería Anillas

Ref. \longleftrightarrow mm

68008 160

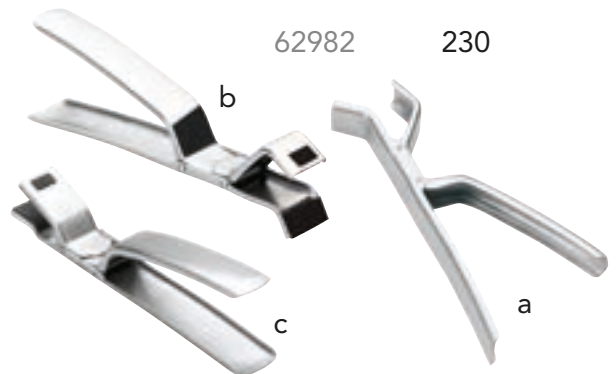

Pinza Multiusos

Marca: APS

Ref. descripción \longleftrightarrow mm

62989	Pinza horno	200	a
62998	Pinza horno c/silicona	200	b
00686	Pinza platos	250	c



Pinza Karu

Marca: Lacor

Ref. \longleftrightarrow mm Ref. \longleftrightarrow mm

63060	240	63070	300	Rojo
63061	240	63071	300	Negro
63062	240	63072	300	Azul
63063	240	63073	300	Amarillo
63064	240	63074	300	Verde
63065	240	63075	300	Marrón

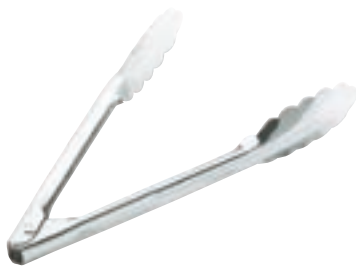

Pinza Jumbo

Ref.	<—> mm
62924	240
62930	300
62940	400



Pinza Jumbo Nylon

Ref.	<—> mm
62926	240
62929	300
62939	400



Pinza Servir

Ref.	<—> mm
62353	240



Pinza Silicona

Ref.	<—> mm	
64432	180	Naranja
64433	180	Rojo
64436	180	Azul
64437	180	Verde
64439	180	Morada



Pinza Grill

Ref.	<—> mm
62933	300



Pinza Emplatar

Ref.	<—> mm
62956	210
62955	155



Pinza Emplatar Precisión

Ref.	<—> mm
62821	210
62954	160



Bandejas Horno



Bandeja hierro borde recto

Ref.	←→ mm	Alt mm
532053	530x325	20
536240	400x300	20
536260	600x400	20



Bandeja hierro borde redondo

Ref.	←→ mm	Alt mm
532132	325x265	10
532153	530x325	10
532165	650x530	10
536340	400x300	10
536360	600x400	10

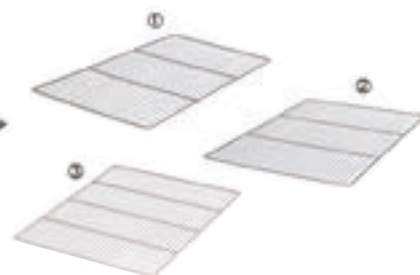

Rejilla Acero

Ref.	←→ mm	Alt mm
333053N	530x325	
333060N	600x400	
333065N	650x530	



Bandeja aluminio borde recto

Ref.	←→ mm	Alt mm
736260	600x400	20



Bandeja aluminio borde redondo

Ref.	←→ mm	Alt mm
736040	400x300	10
736053	530x325	10
736060	600x400	10

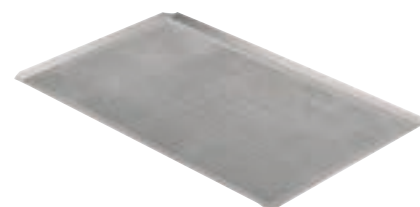

Bandeja aluminio perforada

Ref.	←→ mm	Alt mm
736740	400x300	10
736753	530x325	10
736760	600x400	10



Bandeja acero borde recto

Ref.	←→ mm	Alt mm
332032	325x265	7
332053	530x325	15
332065	650x530	15
336040	400x300	15
336060	600x400	17



Bandeja acero borde redondo

Ref.	←→ mm	Alt mm
332153	530x325	10
332165	650x530	10
336140	400x300	10
336160	600x400	10



Taete Silicona

Ref.	←→ mm
493140N	400x300
493158N	600x400
493151N	530x325

Preparación



Caldero cónico c/asas

Ref.	<—> cm	lts
50828	28 Øx13,2 h	5,00
50832	32 Øx14,5 h	7,00
50836	36 Øx16,0 h	11,00
50840	40 Øx18,0 h	15,00
50845	45 Øx20,0 h	22,00
50850	50 Øx21,0 h	30,00



Caldero semiesférico s/asas

Ref.	<—> cm	lts
50323S	22 Øx11,0 h	2,70
50327S	26 Øx13,0 h	4,00
50333S	32 Øx17,0 h	9,50
50337S	36 Øx18,0 h	12,00
50341S	40 Øx21,0 h	14,50



Caldero semiesférico c/asas

Ref.	<—> cm	lts
50323	22 Øx11,0 h	2,70
50327	26 Øx13,0 h	4,00
50333	32 Øx17,0 h	9,50
50337	36 Øx18,0 h	12,00
50341	40 Øx21,0 h	14,50



Fuente cónica honda

Ref.	<—> cm	lts
60013	13 Øx6,1 h	0,55
60016	16 Øx9,1 h	1,00
60020	20 Øx11,7 h	2,12
60024	24 Øx12,6 h	3,50
60028	28 Øx13,4 h	5,25
60032	32 Øx15,0 h	7,65
60036	36 Øx16,0 h	11,00
60040	40 Øx18,0 h	15,00



Soporte caldero semiesférico

Ref.
50300



Bol cónico inox 18% Cr

Ref.	<—> cm	lts
14016	16 Øx6,5 h	0,90
14019	20 Øx7,5 h	1,40
14025	24 Øx9,0 h	2,50
14029	30 Øx11,0 h	4,30
14033	34 Øx13,5 h	7,50



Guantes



Guante algodón+silicona

Ref.	<—> cm
61033	33,0



Guante algodón aluminado

Ref.	<—> cm
61024	24,0
61030	30,0
61036	36,0



Guante silicona

Ref.	<—> cm
60010	29,0
60011	42,0

Aros-Moldes

Aro redondo



Marca: Lacor

Ø cm	3,5 cm h	4 cm h	4,5 cm h	6 cm h
6		68406	68506	
7				86807
7,5		68407		
8	68308	68408	68508	68608
9			68509	68609
10	68310	68410	68510	68610
12		68412	68512	68612
14		68414	68514	68614
16		68416	68516	68616
18		68418	68518	68618
20		68420	68520	68620
22		68422	68522	68622
24		68424	68524	68624
26			68526	68626
28				68628

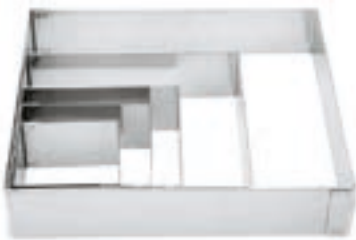

Marca: Lacor

Molde cuadrado

Ref.	<—> cm
68460	6x6x4
68480	8x8x4
68411	10x10x4
68441	14x14x4
68240	20x20x4



Marca: De Buyer

Molde triangular

Ref.	<—> cm
393716	20x4,5 h
393720	25x4,5 h
393724	30x4,5 h

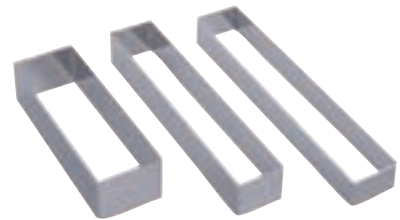

Marca: De Buyer

Molde rectangular

Ref.	<—> cm
394305	5x2,5x2,5 h
394308	8x2,5x2,5 h
394310	10x2,5x2,5 h
394312	12x4x3 h
394313	12x4x4 h
394216	16x3x2,5 h
394118	18x3x2 h



Marca: De Buyer

Molde piramidal

Ref.	<—> cm
302306N	6x6x4 h
302307N	7,5x7,5x5,2 h
302309N	9x9x6 h
302312N	12x12x8 h
302315N	15x15x10 h
302317N	17x17x12 h
302319N	19x19x13 h



Marca: De Buyer

Molde semiesférico

Ref.	<—> cm
313304N	4 Øx2 h
313300N	6 Øx2,7 h
313307N	7 Øx3,5 h
313308N	8 Øx4 h
313309N	9 Øx4,2 h
313310N	10 Øx4,8 h
313312N	12 Øx5,9 h
313314N	14 Øx6,7 h
313316N	16 Øx8 h
313318N	18 Øx8,7 h
313320N	20 Øx10 h

Medida



Marca: Lacor

Jarra medidora

Ref.	<—> cm	lts
62750	17 Øx22,5 h	5,00



Marca: Lacor

Jarra medidora cónica

Ref.	lts
67010	1,00



Marca: Lacor

Juego cucharas medida

Ref.	ml
67001	0,62/1,25/2/5/15



Marca: Lacor

Juego cazos medida

Ref.	ml
67007	60/80/125/250



Marca: Lacor

Librador inox

Ref.	<—> cm	ml
67012	19,0	60
67013	21,5	110
67014	24,0	200
67016	25,5	260
67017	29,0	360
67018	31,0	470
67019	35,0	640
67020	38,0	860



Marca: Lacor

Librador PC

Ref.	ml
67021	170
67022	900
67023	1800

Espátulas-pinceles



Marca: Lacor

Espátula silicona mango inox

Ref.	cm
67421	20
67427	26
67433	32



Marca: Lacor

Espátula silicona

Ref.	cm
64460	25
64461	35



Marca: Lacor

Espátula-cuchara silicona

Ref.	cm
64450	25
64451	35



Marca: Lacor

Pincel silicona inox 18/10

Ref.	cm
64418	22
64422	24
64438	24



Marca: Lacor

Pincel silicona mango inox

Ref.	cm
64425	24x6
64431	24x8

Mangas-decoración



Marca: De Buyer

Manga pastelera poliuretano

Ref. **<—> mm**

434735	350
434745	450
434750	500



Marca: De Buyer

Soporte mangas

Ref. **<—> mm**

434710N	195x230 h
---------	-----------



Marca: Lacor

Manga pastelera nylon

Ref. **<—> mm**

68930	30
68935	35
68940	40
68945	45
68950	50
68955	55
68960	60
68965	65
68970	70



Marca: De Buyer

Soporte mangas mural

Ref. **<—> mm**

434720N	500x500
---------	---------



Marca: Ibili

Set boquillas policarbonato 23 ud

Ref. 783800



Marca: Lacor

Manga pastelera desechable

- Galga 280
- Paquete 100 ud

Ref. **<—> mm**

68939	40
68954	55
68964	65



Marca: Ibili

Set boquillas rusas

Ref. 252000



Marca: Ibili

Set boquillas rusas XL

Ref. 252001



Corte



Mandolina kobra con pulsador

Ref. <—> mm

201101 365x122x80

Marca: De Buyer



Marca: Tellier

Rasqueta plástico flexible

Ref. <—> mm

485800N 15x11x0,2

Marca: De Buyer

Mandolina japonesa N4291

• ABS

<—> cm

34,5x14,5x2,3

Extractor manual frutas

Ref. <—> mm

261201 12 Ø
261202 20 Ø
261203 30 Ø

Marca: De Buyer



Marca: Tellier

Sacabocado turn up

Ref. <—> mm

N7103 30 Ø
N7101 40 Ø
N7102 50 Ø



Marca: De Buyer

Rodillo cortapasta extensible

Ref. <—> mm

478100N 5,5 Ø
478102 10,0 Ø

Sifones-cedazos



Marca: Lacor

Sifón crema inox

Ref.	Its
68404	0,50
68405	1,00



Marca: Lacor

Cedazo acero

Ø cm	Paso 50	Paso 35	Paso 25	Paso 20
12	68052			
16	68056			
18	68058			
20	68050	68350	68250	
26	68057	68357	68252	68026
30	68053	68351	68253	68023
40	68054	68354	68254	68024



Marca: Lacor

Carga sifón N20

Ref.	Pack
68402	10
68403	24



Marca: Lacor

Cribador harina

Ref.	Ø
67011	10
67015	12

Especiero 7 cm Ø x 11 cm h

Ref.	Descripción
62906	Especiero agujeros pequeños
62905	Especiero agujeros grandes
62904	Especiero agujeros queso
62907	Especiero hierbas
62903	Especiero malla fina



Marca: Lacor

Rodillos



Marca: Lacor

Rodillo inox 18/10

Ref.	←→ mm
67140	400/200
67148	480/250
67156	560/330

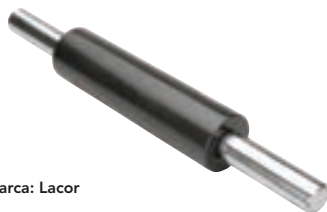

Marca: Lacor

Rodillo antiadherente

Ref.	←→ mm
67141	400/200
67149	480/250



Marca: Lacor

Rodillo madera haya

Ref.	←→ mm
68153	500/300
68154	600/400

Medición



Marca: Lacor

Báscula

Ref.	Kg
------	----

61703	5 kg / 1 gr
-------	-------------



Marca: Lacor

Báscula precisión

Ref.	gr
------	----

61709	650 / 0,1
-------	-----------



Marca: Lacor

Termómetro laser

Ref.	T
------	---

62457	-80°C / 400°C
-------	---------------



Marca: Lacor

Termómetro horno

Ref.	T
------	---

62454	50°C / 300°C
-------	--------------



Marca: Lacor

Termómetro refrigerador

Ref.	T
------	---

62450	-30°C / 30°C
-------	--------------



Marca: Lacor

Termómetro carne

Ref.	T
------	---

62452	-54°C / 88°C
-------	--------------



Marca: Lacor

Termómetro digital c/sonda

Ref.	T
------	---

62498	0°C / 300°C
-------	-------------



Marca: De Buyer

Termómetro digital

Ref.	T
------	---

488100	-50°C / 200°C
--------	---------------

Aceiteras



Marca: Ibili

Aceitera

Ref.	lts
------	-----

709703	0,30
709705	0,50
709710	1,00



Marca: Lacor

Aceitera cónica

Ref.	lts
------	-----

62525	0,25
62555	0,50
62551	1,00

Moldes silicona black

- Silicona 60x40 cm.
- 60°C / +230°C

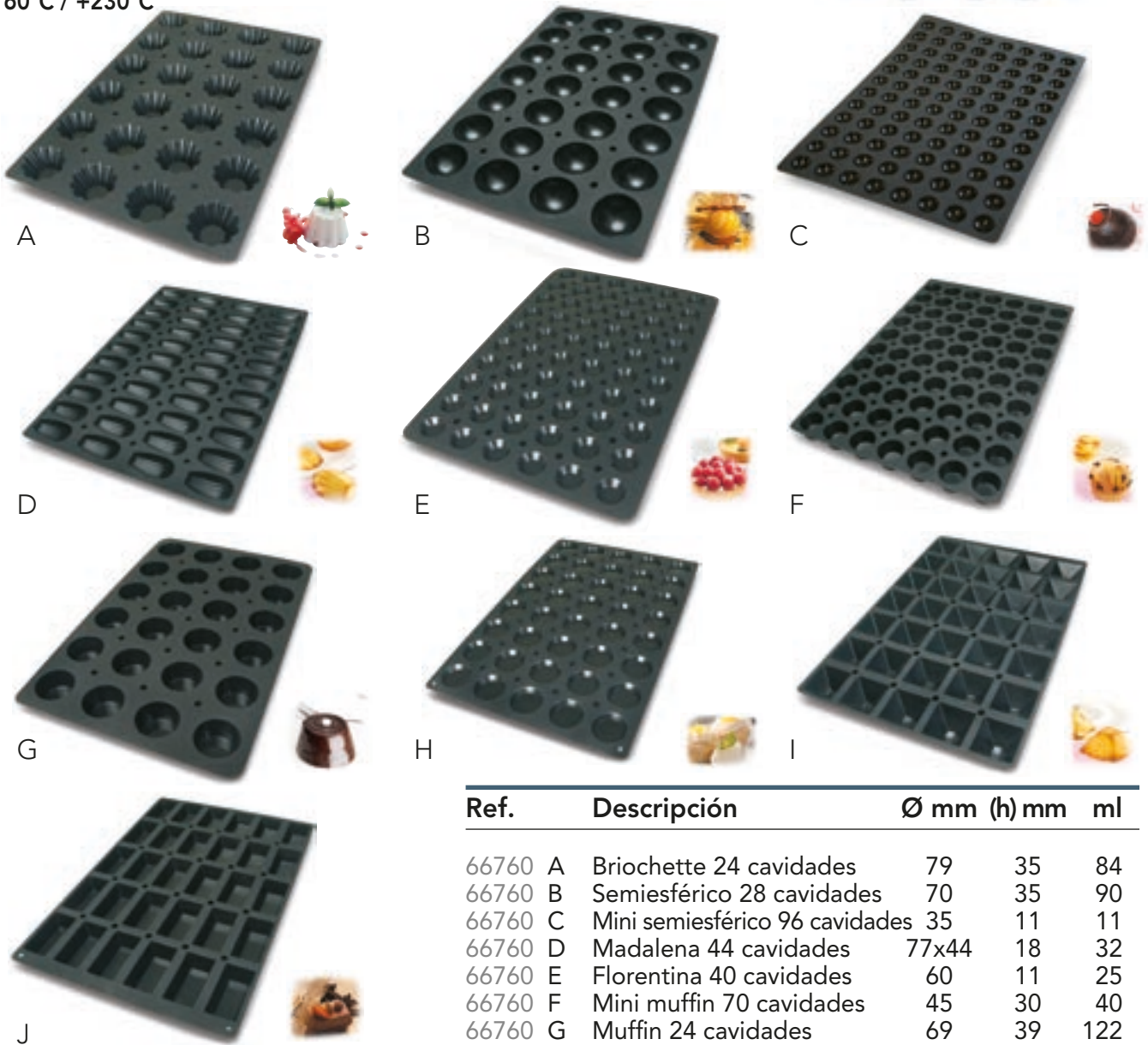

Ref.	Descripción	Ø mm	(h) mm	ml
66760 A	Briochette 24 cavidades	79	35	84
66760 B	Semiesférico 28 cavidades	70	35	90
66760 C	Mini semiesférico 96 cavidades	35	11	11
66760 D	Madalena 44 cavidades	77x44	18	32
66760 E	Florentina 40 cavidades	60	11	25
66760 F	Mini muffin 70 cavidades	45	30	40
66760 G	Muffin 24 cavidades	69	39	122
66760 H	Tartaleta 60 cavidades	44	10	10
66760 I	Piramide 35 cavidades	65x65	35	61
66760 J	Mini cake 30 cavidades	99x49	30	110

Moldes silicona

- -40°C / +260°C
- Con anillo de refuerzo



Molde cake

Ref. <—> mm

- 66733 240x100x65
- 66742 260x100x70



Molde savarin bajo

Ref. <—> mm

66734 230 Ø x 60 h



Molde savarin alto

Ref. <—> mm

66735 230 Ø x 105 h



Molde redondo

Ref. <—> mm

- 66737 240 Ø x 45 h
- 66738 260 Ø x 45 h



Molde tarta

Ref. <—> mm

66739 290 Ø x 35 h

Moldes silicona pastryflex



- Silicona 175x300 mm.
- -40°C / +260°C

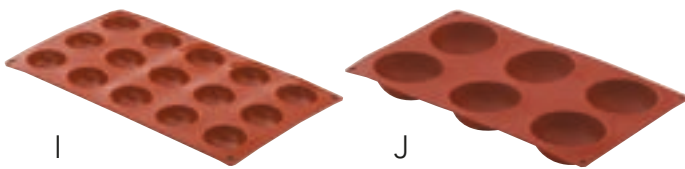
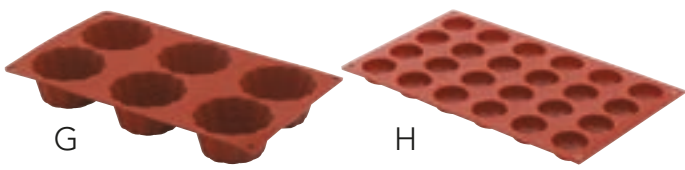
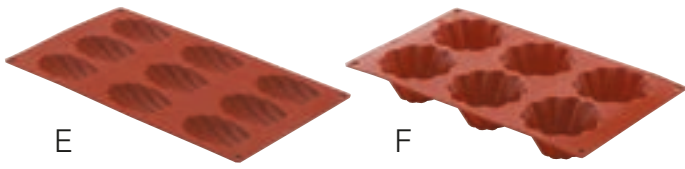
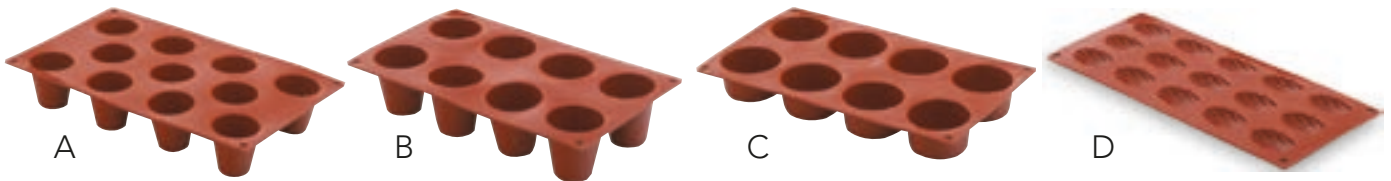

Ref.	Descripción	Ø mm	(h) mm
66812	A Cilindro 11 cavidades	45	48
66813	B Cilindro 8 cavidades	55	60
66807	C Cilindro 6 cavidades	60	35
66816	D Madalena 15 cavidades	42x30	11,5
66817	E Madalena 9 cavidades	78x45	17
66819	F Briochette 6 cavidades	103	20
66820	G Briochette 6 cavidades	79	30
66800	H Semiesfera 24 cavidades	30	17
66801	I Semiesfera 15 cavidades	40	20
66802	J Semiesfera 6 cavidades	70	35
66821	K Piramide 15 cavidades	36	22
66822	L Piramide 6 cavidades	71	41

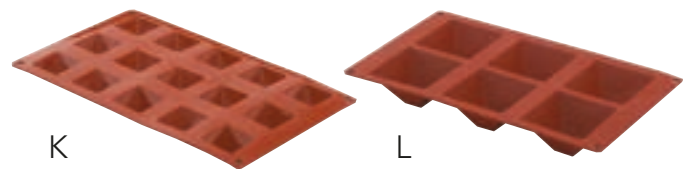

Ref.	Descripción	Ø mm	(h) mm
66823	A Oval 16 cavidades	53x33	20
66805	B Muffin 6 cavidades	70	40
66804	C Mini muffin 11 cavidades	50	28
66824	D Corazón 8 cavidades	65x60	35
66825	E Rectángulo 20 cavidades	49x26	11
66826	F Cake 12 cavidades	80x30	30
66827	G Petit four 15 cavidades	40	20
66828	H Pomponette 24 cavidades	34	16
66808	I Mini savarin 15 cavidades	41	12
66830	J Base esponjosa 3 cavidades	103	20
66844	K Mini bordelais 18 cavidades	25	30

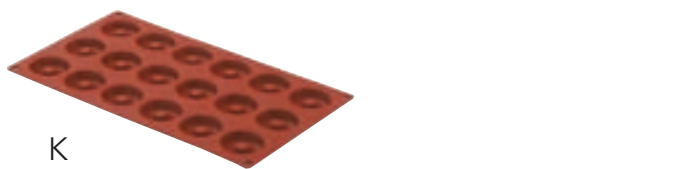
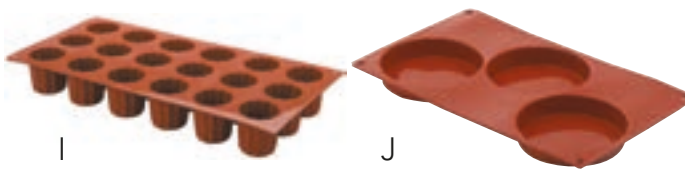
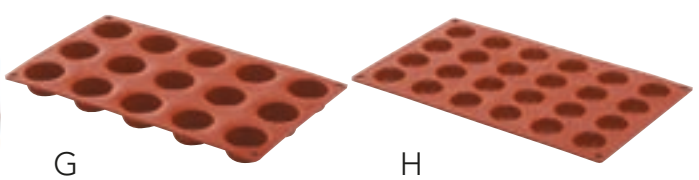
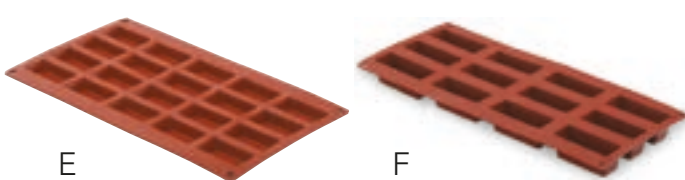
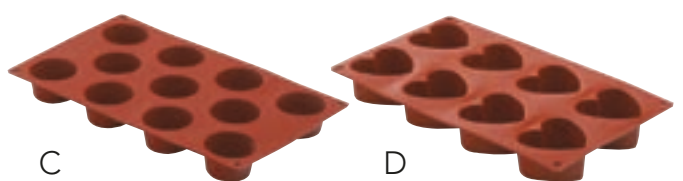
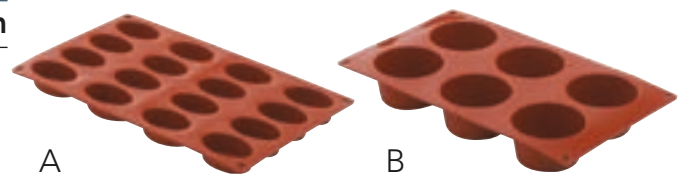

COCINA

Moldes



Molde cake antiadherente

Ref. <—> mm

68714 240Ø x 70 h
68716 260Ø x 70 h
68718 280Ø x 70 h



Molde savarin antiadherente

Ref. <—> mm

68724 240Ø x 65 h
68862 260Ø x 65 h
68863 280Ø x 65 h



Molde rizado antiadherente

Ref. <—> mm

68842 240 Ø
68882 280 Ø
68823 320 Ø



Tartaleta rizada

Ref. <—> mm

68104 40 Ø
68105 50 Ø
68109 90 Ø
68110 100 Ø
68112 120 Ø
68113 140 Ø



Madalena rizada

Ref. <—> mm

68015 50 Ø
68016 60 Ø
68019 90 Ø



Tartaleta lisa

Ref. <—> mm

68119 90 Ø



Cornete

Ref. <—> mm

68936 120



Molde cake inox

Ref. <—> mm

65925 250x120x85
65930 300x120x85
65935 350x120x85



Molde cake antiadherente

Ref. <—> mm

68725 250x120x85
68730 300x120x85
68735 350x120x85



Flanero aluminio

Ref. <—> mm

60006 240 Ø x 65 h
60007 70 Ø x 50 h
60008 80 Ø x 53 h



Flanero inox

Ref. <—> mm

12406 60 Ø x 49 h
12407 70 Ø x 49 h
12408 80 Ø x 50 h

Marco rectangular inox

Ref. <—> mm

68043 300x400x30
68048 310x480x30
68060 400x600x30
68041 300x400x50
68049 310x480x50
68061 400x600x50



Bandeja rectangular inox

Ref. <—> mm

68030 300x400x10
68031 310x480x10
68040 400x600x10

Máquinas



Corta-patatas

Ref.	Descripción
CX06	Cuchilla y empujador 6 mm
CX08	Cuchilla y empujador 8 mm
CX10	Cuchilla y empujador 10 mm
CX13	Cuchilla y empujador 13 mm



Cortador tomates secciones

Ref.	Descripción
CAX104	4 Secciones
CAX106	6 Secciones
CAX108	8 Secciones
CAX112	12 Secciones



Corta-patatas con pié

Ref.	Descripción
CP06	Cuchilla y empujador 6 mm
CP08	Cuchilla y empujador 8 mm
CP10	Cuchilla y empujador 10 mm
CP13	Cuchilla y empujador 13 mm



Cortadora tomates CTX55

- 48X20X32 cm
- Espesor rodaja 5,5 mm



Cortadora tomates CTXM55

- 30X14X18 cm
- Espesor rodaja 5,5 mm



Pelador manzanas N4230

- 39X12,5X21 cm
- Espesor rodaja 4 mm



Multi cortadora MCX

- Corte en rodajas: 5,5 mm
- Corte en sectores: 6/8 ud
- Corte en bastoncillos: 8/10 mm



Pelador-descorazonador piña EA

- Diámetro: 74/89/95/102 mm
- 45x39x72 cm



Cortador lechuga CSA

- 39X42X120 cm



Línea antialérgica

NUEVO



Prepare y sirva comida que no contengan alérgenos. Determine los utensilios que va a usar para preparar y servir comidas que no contengan alérgenos, color morado para una rápida identificación por parte de los empleados y clientes.



Gastronorm polipropileno

Ref.	tipo	Hmm	lts.
P111.5P6	1/1	150	19,60
P121.5P6	1/2	150	8,70
P131.5P6	1/3	150	5,00
P161.5P6	1/6	150	5,00



Tapa Polinorm

Ref.	Mod.	U.
P110.0P6	1/1	30
P120.0P6	1/2	60
P130.0P6	1/3	30
P160.0P6	1/6	60



Caja de almacenamiento

Ref.	<—>	L cm	U
1527-C80cj		38,1x50,8x17,8	6
1500-C80tp		39,7x57,2x6,4	6
1522-C80tp		10,3x54,9x2,5	6



Bol servicio doble redondo

Ref.	cms	lts.	U
4658765	14,4x7.6	0,7	6
4659065	18,4x10,3	1,6	6
4659165	24,1x12.9	3,2	6
4659265	30x16,5	6,6	3
4656965	35x17.5	9,6	2



Bol servicio doble cuadrado

Ref.	cms	lts.	U
4761965	14,4x7.6	0,7	6
4763265	18,4x10,3	1,6	6
4763465	24,1x12.9	3,2	6
4763565	30x16,5	6,6	3
4656965	35x17.5	9,6	2



Tabla de corte

Ref.	L cm	U
5200080	30,5x45,7x1,3	6



Accesorios

Ref.	<—>	cms
Batidor 47003		12
Cacillo 4980280		25 (60ml)
Pinzas 4780980		24
Cuchara 6414080		35
Espátula 4808880		42 (21x7,5)



Sartén antiadherente

Ref.	Ø cm	Hcm	U
T400780	18	4,0	6
T400880	20	5,0	6
T401080	25	5,0	6
T401280	30	5,5	2

CAFETERÍA Y SERVICIOS DE MESA

*Cafeteria and Table Service • Service de Cafétéria
Caffetteria e Tavolo di Servizio • Cafeteria und TISCH*



Cafetería

Classic



Código	Descripción	Capacidad (lt)
--------	-------------	----------------

62215	Lechera	0,15
62225	Lechera	0,25
62235	Lechera	0,35
62260	Lechera	0,60
62210	Lechera	1,00
62216	Lechera	1,50
62220	Lechera	2,00
62023	Tetera	0,23
62035	Tetera	0,35
62060	Tetera	0,60
62010	Tetera	1,00
62135	Cafetera	0,35
62160	Cafetera	0,60
62110	Cafetera	1,00
62115	Cafetera	1,50
62120	Cafetera	2,00



Código	Descripción	Capacidad (lt)
--------	-------------	----------------

882015	Lechera	0,15
882035	Lechera	0,35
882050	Lechera	0,50
882100	Lechera	1,00
882175	Lechera	1,75
880020	Tetera	0,20
880035	Tetera	0,35
880050	Tetera	0,50
880100	Tetera	1,00
880175	Tetera	1,75
881035	Cafetera	0,35
881050	Cafetera	0,50
881100	Cafetera	1,00
881175	Cafetera	1,75

Cosmo



Bella

Código	Descripción	Capacidad (lt)
--------	-------------	----------------

020901	Lechera	0,15
020902	Lechera	0,25
020903	Lechera	0,50
020904	Lechera	1,00
020401	Tetera	1,15
020402	Tetera	0,25
020403	Tetera	0,50
020215	Cafetera	0,25
020216	Cafetera	0,50
020217	Cafetera	1,00





Latina



Código	Descripción	Capacidad (lt)
010901	Lechera	0,15
010902	Lechera	0,25
010903	Lechera	0,50
010904	Lechera	1,00
010905	Lechera	1,50
010906	Lechera	2,25
011601	Tetera con filtro	0,12
011602	Tetera con filtro	0,25
011603	Tetera con filtro	0,50
011607	Tetera sin filtro	0,12
011608	Tetera con filtro	0,25
011609	Tetera con filtro	0,50
010407	Cafetera	0,25
010408	Cafetera	0,50
010409	Cafetera	1,00
010410	Cafetera	1,50

Barista



Código	lt
--------	----

90125	0,25
90135	0,35
90150	0,50
90175	0,75
90110	1,00
90115	1,50



Lechera Negra

Código	lt
--------	----

2535	0,35
2550	0,50
2575	0,75



Lechera Blanca

Código	lt
--------	----

2435	0,35
2450	0,50
2475	0,75



Lechera Verde

Código	lt
--------	----

2835	0,35
2850	0,50
2875	0,75



Lechera Roja

Código	lt
--------	----

2735	0,35
2750	0,50
2775	0,75



Lechera Naranja

Código	lt
--------	----

2635	0,35
2650	0,50
2675	0,75

Teteras



Tetera Stove

Código	lt
621702	0,20
621704	0,45
621708	0,80



Tetera Cristal

Código	lt
622303	0,35
622306	0,60
622309	0,95



Tetera Hierro Negra

Código	lt
620003	0,30
620007	0,72
620012	1,20



Tetera Hierro Hanoi

Código	lt
622603	0,30



Tetera Inox Tokio

Código	lt
622104	0,45



Tetera Hierro Nepal

Código	lt
622805	0,50



Código	Descripción	Capacidad (lt)
--------	-------------	----------------

62716	Jarra s/retén	1,5 - 12x16 cm
62721	Jarra s/retén	2,0 - 12x23 cm
62726	Jarra s/retén	2,5 - 12x26 cm
62715	Jarra c/retén	1,5 - 12x16 cm
62720	Jarra c/retén	2,0 - 12x23 cm
62725	Jarra c/retén	2,5 - 12x26 cm



Jarra Termo

Código	lt
63360	0,60
63310	1,00
63315	1,50
63320	2,00



Jarra Termo Luxe

Código	lt
63360	0,60
63310	1,00
63315	1,50
63320	2,00



Servidor Termo

Código	lt
62481	1,00
62482	1,20
62485	1,50
62486	2,00



Servidor Termo D/Pared

Código	Descripción	Capacidad (lt)
62483	Blanco	1,00
62484	Negro	1,00



Cafetera Pava

Código	lt
68215	1,50
68225	2,50
68235	3,50
68205	5,00



Hervidor

Código	lt
68619	2,00
68627	2,50
68629	3,00
68639	4,00
68649	5,00



Air Pot

Código	lt
62472	2,50
62473	3,00
62475	3,50



Jarra Policarbonato

Código	lt
P600CW	1,80
P480CW	1,40
P320CW	0,95



Jarra Oval Inox

Código	lt
1750	1,00

Cubiteras

Serie Latina

Código	Descripción	Dimensiones (cm)
--------	-------------	------------------

010703	Cubo 1 botella	18 Ø - 4 lt
010704	Cubo 2 botellas	22 Ø - 7 lt
016205	Portacubos	69h
010702	Cubo hielo	10 Ø - 0,75 lt



Serie Bella

Código	Descripción
--------	-------------

021102	Cubo 1 botella P/simple 4 Lt
021103	Cubo 1 botella P/doble 4 Lt
021104	Cubo 2 botellas P/simple 7 Lt
021105	Cubo 2 botellas P/doble 7 Lt
026201	Portacubos



Bella

Latina



Cubo 1 botella anillas
Cod. 311F71
20 Ø x 19h cm



Cubo 1 botella pomos
Cod. 311F72
20 Ø x 19,5h cm

Pulido
satinado

pujadas
PROFESIONAL COOKWARE



Cubo 2 botellas anillas
Cod. 3212F51
20 Ø x 20h cm



Cubo 2 botellas pomos
Cod. 311F52
20 Ø x 20h cm



Portacubos 1 botella
Cod. 311004
18 Ø x 67,5h cm



Portacubos 2 botellas
Cod. 311020
22 Ø x 69,0h cm



Soporte Mesa

Código	(cm)
--------	------

62478	18 Ø
62479	20 Ø



Cubo Oval
Cod. 62338
30x20x20cm - 7,0 lt

LACOR

Cubo Luxe

Código	Descripción	Dimensiones (cm)
--------	-------------	------------------

62315	Cubo hielo	14 Ø - 1,20 lt
62320	Cubo 1 botella	20 Ø - 4,50 lt
62322	Cubo 2 botellas	22 Ø - 5,50 lt



Portacubos Luxe
Cod. 62300
20 Ø x 65h cm



Portacubos Oval
Cod. 62342
30x20 x 64h cm

Champaneras



Barreño liso o oval

Código	Dimensiones (cm)
--------	------------------

62271	43x30x20 - 20 lt
62272	53x38x25 - 27 lt
62273	61x43x28 - 32 lt

Luxe

Código	Dimensiones (cm)
--------	------------------

62436	36 Ø - 11,5 lt
62439	40 Ø - 15 lt



Enfriador inox

Código	Dimensiones (cm)
--------	------------------

62346	36 Ø x 20 - 13 lt
62347	40 Ø x 20 - 16 lt



Champanera redonda

Policarbonato + acero inox
Cod. 36049
44 Ø x 25h cm



Champanera oval

Acrílico
Cod. 36057
47 Ø x 28h cm



Champanera doble pared

Acero inox
Cod. 36044
44 Ø x 24h cm



Champanera acrílica

Código	Descripción	Dimensiones (cm)
--------	-------------	------------------

36078	Transparente	20 Ø x 25h - 3,50 lt
36079	Negra	20 Ø x 25h - 3,50 lt
36080	Blanca	20 Ø x 25h - 3,50 lt



Champanera acrílica oval

Código	Descripción	Dimensiones (cm)
--------	-------------	------------------

36048	2 botellas Blanca	35x27x25,5 - 6,0 lt
36052	1 botella Blanca	27x20x21,0 - 3,0 lt
36054	2 botellas Negra	35x27x25,5 - 6,0 lt
36053	1 botella Negra	27x20x21,0 - 3,0 lt



Vinagreras



Basic

Código	Descripción
62864	Vinagrera Basic 2/p
62862	Vinagrera Basic 4/p



Hiperlux

Código	Descripción
62463	Vinagrera Hiperlux 2/p
62465	Vinagrera Hiperlux 4/p



Soportes



Código	Descripción	mm
3213	Soporte 2 huecos	57
3214	Soporte 4 huecos	57
3215	Soporte 2 huecos	65
3216	Soporte 4 huecos	65



Bella

Código	Descripción
021204	Vinagrera Bella 2/p
021205	Vinagrera Bella 4/p

Molinillos de pimienta

Paris

Código	Descripción	Altura (cm)
PIMIENTA SAL		
23447	23454 Molinillo Madera	12
23461	23478 Molinillo Madera	18
23485	23492 Molinillo Madera	22
23508	23515 Molinillo Madera	27
23522	23539 Molinillo Madera	30
23546	23553 Molinillo Madera	40



Zeli

Código	Descripción	Altura (cm)
PIMIENTA SAL		
24079	24086 Molinillo Inox	14

Daman

Código	Descripción	Altura (cm)
PIMIENTA SAL		
25427	25434 Molinillo Inox/acryl	16
25441	25458 Molinillo Inox/acryl	21



Saleros



Basic
Cod. 62866



Hiperlux
Cod. 62461



Cod. 1523



Cod. 1524



Cod. 1525



Cod. 1514

Servilleteros

Mini-servis Acero



Cod. 8058
Todo inox



Cod. 8060
Inox - Base plástico



Cod. 8061
Inox - Base plástico
Palillero Negro



Cod. 8063
Inox - Base plástico
Palillero Cromado



Cod. 8059
Todo inox
Con portacartas

Mini-servis Madera



Cod. 25000



Cod. 25002
Con portacartas



Cod. 25020
Con palillero

Mini-servis Cobre



Cod. 8058C



Cod. 8059C
Con portacartas

Coctel Inox



Cod. 8064

Coctel Madera



Cod. 140302



Cod. 140301
Con palillero

Engarzadas



Cod. 8062

Presentación

Mini caja cuadrada



Código **Dimensiones (cm)**

2005 17x17x7
2004 21x21x7

Mini caja rectangular



Código **Dimensiones (cm)**

2007 24x16x7

Mini caja alta



Código **Dimensiones (cm)**

2007 17x13x9

Mini palet



Código **Dimensiones (cm)**

2000 12x8
2002 20x12

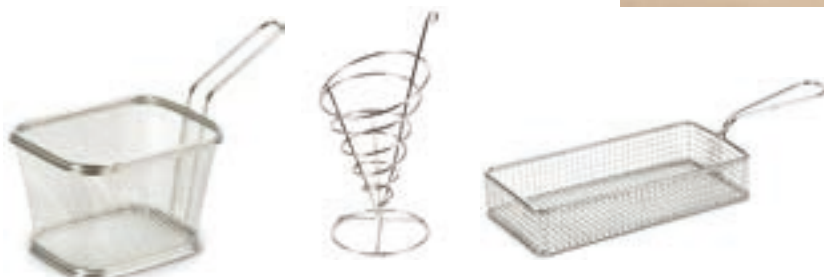

Código **Descripción** **cm**

1993 Cesto Cuadrado 10x9
1994 Cesto Cuadrado 13x11
1991 Cesto Redondo 8 Ø
1992 Cesto Redondo 9 Ø
1996 Cono Chips 11x23
1995 Cesto Rectangular 25x10



Código **Descripción** **cm**

2815 Carrito 9x11x14
2817 Carrito 12x14x16
2818 Mini Cesta 14x10x5
2819 Mini Cesta 18x13x9

Mini olla



Cod. 6304



Cod. 6304/1

Código	Dimensiones (cm)
--------	------------------

6304	9x6
6304/1	9x6

Mini cazo



Cod. 6302



Cod. 6302/1

Código	Dimensiones (cm)
--------	------------------

6302	7x5
6302/1	7x5

Mini wok



Código	Dimensiones (cm)
--------	------------------

6305	11x5
------	------

Mini rustidera



Cod. 6301



Cod. 6301/1

Código	Dimensiones (cm)
--------	------------------

6301	14
6301/1	14

Mini lechera



Código	Capacidad (cl)
--------	----------------

6306	80
6307	150
6308	300

Mini cubo



Cod. 6309-10-12



Cod. 6309-10-1

Código	Dimensiones (cm)
--------	------------------

6309	7x7
6310	9x9
6312	12x12
6309/1	7x7
6310/1	9x9

Mini salsaera



Código	Dimensiones (cm)
--------	------------------

6311	5x3
------	-----

Mini sartén



Código	Dimensiones (cm)
--------	------------------

6303	10x3
------	------



Botellas



3904



3903



3900



3901



3902



3909



3910



3911



3906



Código	Dimensiones (cm)
--------	------------------

3900	7,5x29
3901	7,5x29
3902	7,5x29
3903	12x46
3904	13x45
3906	7x24,5
3909	8x30
3910	8x30
3911	8x30

Jamoneras

Huelva



Código	Descripción
--------	-------------

3919	Color Nogal
------	-------------

Rioja



Código	Descripción
--------	-------------

4091	Color Natural
8921	Color Nogal
4237	Color Tabaco

Rioja Alto



Código	Descripción
--------	-------------

9249	Color Natural
6316	Color Tabaco

Elite Inoxidable



Código	Descripción
--------	-------------

4240	Polietileno Negro
------	-------------------



Pata Negra



Código	Descripción
--------	-------------

9256	Color Natural
6293	Color Tabaco
8105	Color Roble

Elite Plus Inoxidable



Código	Descripción
--------	-------------

4299	Polietileno Negro
------	-------------------

Mesa Jamonera



Código	Descripción
--------	-------------

14021	Mesa 600x600 mm
14045	Mesa 800x600 mm



Código	Descripción
--------	-------------

14069	Mesa 1200x600 mm
-------	------------------

Panera Mimbre Redonda



Código	Dimensiones (cm)
1020	22 Ø
1021	25 Ø
1022	29 Ø
1023	32 Ø

Panera Mimbre Oval



Código	Dimensiones (cm)
1030	20,0
1031	22,0
1032	25,0
1033	28,0
1034	31,0
1035	34,0

Panera Polyrattan



Código	Descripción	Dimensiones (cm)
30279	Panera Oval	18x12
30280	Panera Oval	23x15
30282	Panera Oval Baguette	21x10
30284	Panera Oval Baguette	36x15
30281	Panera Redonda	20 Ø
30285	Panera Redonda	25 Ø
30283	Panera Rectangular	22x15
30286	Panera Rectangular	30x22
30288	Panera Rectangular	41x29
30287	Panera Cuadrada	24x24

Tela Beige



Código	Dimensiones (cm)
30340	17 Ø
30350	20 Ø
30360	20x15
30370	25x18

Tela Beige/Negra



Código	Dimensiones (cm)
30341	17 Ø
30351	20 Ø
30361	20x15
3031	25x18

Polipropileno Colores



Código	Descripción	Dimensiones (cm)
B919021	Redonda	18,5 Ø x 7,5h
B919012	Oval	24,5x18,5x8
B919032	Oval	24x14,5x8,5
B919043	Rectangular	23x18x8
B919058	Baguette	28x11x,5
B919008	Cubiertos	12,5 Ø x 14h

Colores disponibles



Portamenús

LÍNEAS

FASHION

Piel Regenerada
Espesor 1,2 mm - 14 color

ECO

Fibra Celulosa
Espesor 0,8 mm - 1 color
Espesor 0,6 mm - 3 color
Espesor 1,5 mm - 3 color

VINTAGE

Fibra Celulosa
Espesor 0,5 mm - 1 color
Espesor 1,0 mm - 1 color

SUGUERO

Corcho Natural
Espesor 1,4 mm - 1 color
Espesor 2,5 mm - 3 color

GOLD

Piel Regenerada
Espesor 1,2 mm - 1 color

FORMATOS



Maxi
21x42 cm



A4
21x42 cm



4RE
21x42 cm



Club
21x42 cm



A4 Horizontal
21x42 cm



Cuadrato
21x42 cm



Golfo
21x42 cm



Popis
21x42 cm



Club Horizontal
21x42 cm

ETIQUETAS



Metal Satinado
Personalizable láser



Metal Brillante
Personalizable láser



Patch
Personalizable láser



Minimalista
Sin etiqueta

INTERIOR



A4 Horizontal
21x42 cm

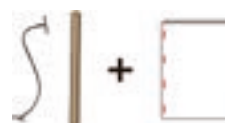

A4 Horizontal
21x42 cm



A4 Horizontal
21x42 cm

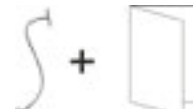

A4 Horizontal
21x42 cm

Fashion



Naranja
1,2 mm



Violeta
1,2 mm



Verde
1,2 mm



Azul
1,2 mm



Burdeos
1,2 mm



Marrón
1,2 mm



Negro
1,2 mm



Gris
1,2 mm



Avestruz Blanco
1,2 mm



Avestruz Negro
1,2 mm



Cocodrilo Marrón
1,2 mm



Cocodrilo Blanco
1,2 mm



Cocodrilo Negro
1,2 mm



Cocodrilo Violeta
1,2 mm

Eco



Gris
0,6 / 1,5 mm



Negro
0,6 / 0,8 / 1,5 mm



Natural
0,6 / 0,8 mm



Marrón
0,8 / 1,5 mm



Marrón
1,2 mm

Sughero



Natural
1,4 mm



Blanco
2,5 mm



Negro
2,5 mm



Marrón
2,5 mm



Marrón
0,5 / 1,0 mm

Vintage

Fuentes / Bandejas

Fuente oval 18/10

Código	Dimensiones (cm)
--------	------------------

62820	
62825	25x17
62830	30x20
62835	35x23
62840	40x26
62845	40x29
62850	50x31
62871	70x32



Fuente pescado 18/10

Código	Dimensiones (cm)
--------	------------------

62860	60x26
62880	80x30



Fuente oval honda 18% CR

Código	Dimensiones (cm)
--------	------------------

61828	30x20x4,5
61832	35x24x4,5
61838	40x26x4,5
61843	45x29x4,5
61848	50x31x4,7



Bandeja camarero

Código	Dimensiones (cm)
--------	------------------

62841	40 Ø
-------	------



Bandeja octogonal 18/10

Código	Dimensiones (cm)
--------	------------------

65026	25x20
65031	31x24
65037	37x27
65041	41x32
65046	46x36



Fuente redonda 18/10

Código	Dimensiones (cm)
--------	------------------

62831	30 Ø
62836	35 Ø



Bandeja camarero antideslizante

Código	Dimensiones (cm)
--------	------------------

P956035	Negro 35 Ø
P956040	Negro 40 Ø
P956135	Marrón 35 Ø
P956140	Marrón 40 Ø



Bandeja oval antideslizante



Código	Descripción	Dimensiones (cm)
--------	-------------	------------------

P862100	Bandeja Oval	68x56
P863000	Soporte Bandejas	47x47x82



Pizarras Sandwich

Código	Descripción	Dimensiones (cm)
P21000	Pizarra Caballete Duo	75x135
P21001	Pizarra Caballete Duo	55x85
P21003	Pizarra Caballete Simple	55x85



Pizarras

Pizarras Pared

Código	Descripción	Dimensiones (cm)
P21004	Pizarra Universal	40x50
P21005	Pizarra Universal	50x60
P21006	Pizarra Universal	60x80
P21007	Pizarra Universal	70x90
P21008	Pizarra Universal	80x100
P21013	Pizarra Curva	50x80



Pizarras



Código	cm
000020	40x150
000021	55x100
000022	40x100
000023	45x70
000024	40x50
000025	20x100
000026	20x50
000027	21x30
000028	15x21

Pizarras de PVC para pared o caballete

Pizarras Sobremesa

Código	Descripción	Dimensiones (cm)
000001	Pizarra Sobremesa	30x40
000002	Pizarra Sobremesa	21x30
000003	Pizarra Sobremesa	15x21
000004	Pizarra Sobremesa	8x15
000005	Portamenú	15x21



Caballetes



Pizarras Sobremesa

Código	Descripción	Dimensiones (cm)
000010	Una cara	30x165
000011	Dos caras	30x115
000012	Dos caras	43x165

Pizarras Sobremesa

Código	Descripción	Dimensiones (cm)
P21015	Pizarra Sobremesa	10x15
P21016	Pizarra Sobremesa	15x21
P21017	Pizarra Sobremesa	21x30



Rotuladores



Código	Descripción
SMA510	Rotulador Fino 2-6 mm trazo
SMA720	Rotulador Fino 7-15 mm trazo

Coctelería



Código	Descripción	Características
93201	Coctelera Boston Inox	30 cm x 9 Ø - 0,70/0,40 lt
93140	Coctelera Boston Cobre	30 cm x 9 Ø - 0,70/0,40 lt
93179	Coctelera Parisien	24 cm x 9,5 Ø - 0,70 lt
62304	Coctelera Tapón Inox	0,75 lt



Código	Descripción	Características
93134	Cuchara Cóctel Inox	27 cm
93034	Cuchara Cóctel Cobre	27 cm
93101	Vaso mezclador	19 cm x 11,5 Ø - 0,95 lt
B001	Botella Bitter	
62326	Colador Gusanillo	15 cm x 10 Ø



Código	Descripción	Características
93164	Jigger Inox	11 cm x 4 Ø - 2,5/5 cl
93165	Jigger Cobre	11 cm x 4 Ø - 2,5/5 cl



Código	Descripción
DP212	Dosificador 2 cl
DP213	Dosificador 3 cl
DP214	Dosificador 4 cl
DP215	Dosificador 5 cl
93319	Tapón Vertedor



Código	Descripción	Características
93180	Machacador Madera	21 cm
93181	Machacador Plástico	21 cm



Código	Descripción	Características
N4107	Exprimidor Manual	15,5 cm
62912	Exprimidor Manual	12 cm Ø - 0,20 lt
N4179	Pinza Exprimidora	8 cm
N4190	Rallador Nuez Tostada	13,6 cm
93189	Prensador Lima	21,7 cm



Código	Descripción
36009	Picadora Manual
93192	Pala hielo



Código	Descripción	Características
93310	Moscow Mule	9 cm x 9 Ø - 0,50 lt
93311	Moscow Mule Martilleada	9,5 cm x 9 Ø - 0,55 lt



Código	Descripción
--------	-------------

93175	Ribeteador Copas
-------	------------------



Código	Descripción
93174	Organizador Bar

Código	Descripción	Dimensiones (mm)
N4401	Caja 4 Dept	305x147x93
N4402	Caja 5 Dept	380x147x93
N4403	Caja 6 Dept	458x147x93



Código	Descripción	Dimensiones (mm)
93166	Tapete Cóctel	30x15
93167	Tapete Cóctel	45x31
93173	Tapete Cóctel	57x8
93168	Tapete Cóctel	60x8



Código	Descripción	Características
93144	Botella Store & Pour	33 cm x 9 Ø - 1 lt
94144	Botella Store & Pour	35 cm x 12,5 Ø - 2 lt

Colores:



Código	Descripción	Características
68601	Sifón Soda	39 cm x 10 Ø - 1 lt
68603	Cargas CO2	Caja 24 ud

Servicio vino



Código	Descripción
63012	Sacacorchos Pared Cromado
63010	Sacacorchos Pared Negro



Código	Descripción
63019	Anillo antigoteo
63037	Descapsulador
63022	Boquilla Servidor
93135	Tapón Champán

Código	Descripción
63033	Bomba vacío (set + 2 tapones)
63035	Tapón bomba vacío
63019	Anilla Anti-Goteo
63022	Vertedor - Boquilla



Sacacorchos
Dos Tiempos
Cod. 107



Sacacorchos Doble Palanca
Cod. 63013



Código	Descripción
63033	Bomba vacío manual
R63033	Tapón Bomba (2 ud)



Código	Descripción
--------	-------------

- | | |
|--------|------------------------|
| 107725 | Limpiador copas |
| 107724 | Limpiador decantadores |
| 107715 | Catavinos Sommelier |
| 107721 | Aireador vino |



Código	Descripción	Capacidad	Dimensiones
69178	Armario Vinos	8 botellas	28x51x45 cm
69187	Armario Vinos	8 botellas	46x51x28 cm
69171	Armario Vinos	18 botellas	38x50x65 cm
69175	Armario Vinos	28 botellas	48x54x74 cm

Cambio - Palilleros - Pinzas

Bandejas cambio

Código	Descripción	Dimensiones (cm)
68007	Bandeja inox c/pinza	15x11
68017	Bandeja inox c/pinza	21x12
68020	Bandeja inox Luxe	21x12
120601	Bandeja madera	15x11
120602	Caja madera	15x11
BAR12	Plato cambio madera	12,5 Ø
61110	Plato cambio inox	10,5 Ø



Código	Descripción
3025	Azucarero Lys
3022	Salero Lys
3006	Dosificador miel



Palilleros

Código	Descripción
983	Palillero cuadrado
1155	Palillero redondo
120203	Palillero madera
120201	Palillero madera c/base
62469	Palillero hiperlux
62470	Palillero luxe



Pinzas

Código	Descripción	Dimensiones (cm)
62306	Pinza hielo	18,5
68008	Pinza repostería c/anillos	16,0
62982	Pinza pan	23,0
62317	Pinza repostería	20,0
62307	Pinza servicio mesa	21,0
62989	Pinza cazuelas	20,0



ALMACENAJE

Storage • Stockage • Stoccaggio • Storage



Cesta Cristalería

FLAP-RACK®

PATENTED EXCLUSIVE

SISTEMA DE MONTAJE Y DESMONTAJE FÁCIL, SEGURO Y SENCILLA PERSONALIZACIÓN /

ABIERTA

APERTURAS PARA MÁXIMA LIMPIEZA

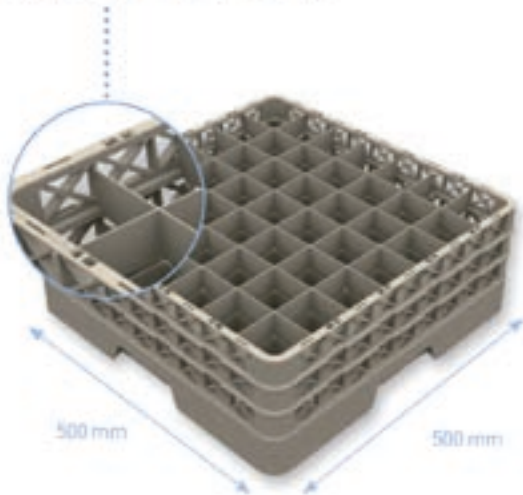

CERRADA

IDEALES PARA EL TRANSPORTE Y EL ALMACENAMIENTO

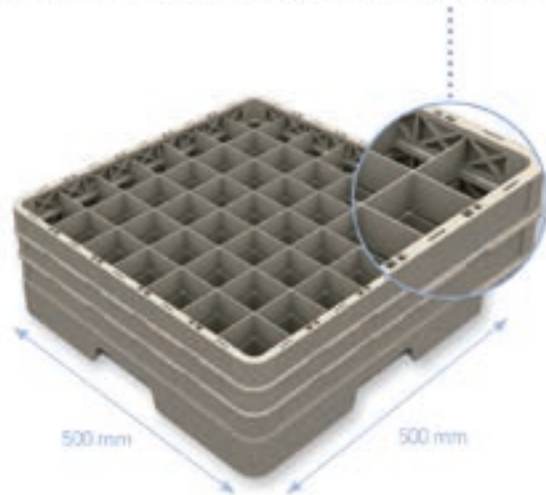

FLAP-RACK®: fácil montaje / desmontaje

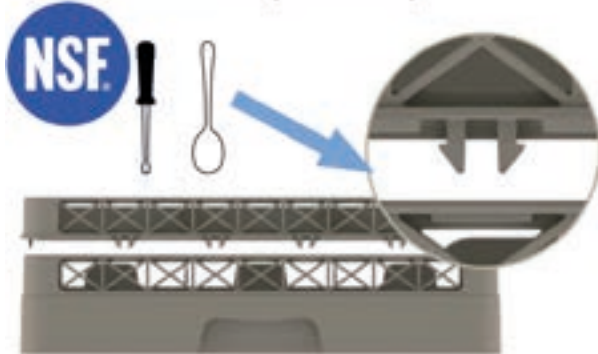

* Copolímero altamente resistente a sustancias químicas y temperaturas de hasta 95 °C



Sistema patentado que permite cerrar y abrir las paredes de las cestas y extensiones fácilmente.



LAVADO: Mayor limpieza



TRANSPORTE: Mayor seguridad



Almacenamiento: Mayor higiene



Ø max 151 mm



Código	Modelo
5090	Cesta Base 9 Dptos
5091	Altura 9 Dptos

Ø max 113 mm



Código	Modelo
5160	Cesta Base 16 Dptos
5161	Altura 16 Dptos

Ø max 89 mm



Código	Modelo
5250	Cesta Base 25 Dptos
5251	Altura 25 Dptos

Ø max 73 mm



Código	Modelo
5360	Cesta Base 36 Dptos
5361	Altura 36 Dptos

Ø max 63 mm



Código	Modelo
5490	Cesta Base 49 Dptos
5491	Altura 49 Dptos

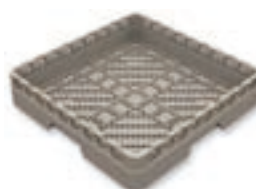
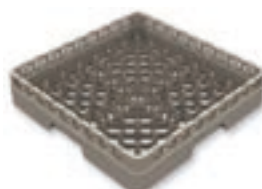
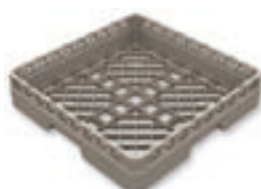

Código	Modelo
5002	Cesta Universal
5003	Cesta Platos
5000	Cesta Cubiertas

Cestas Vajilla



Limpieza y secado rápido.



Almacenamiento y transporte más seguro e higiénico.

Cestas especiales para platos: ideales para el lavado, almacenamiento y transporte de platos. Perfectas para banquetes, hoteles, colectividades y empresas de alquiler de material para la hostelería. Reducen las roturas de platos, minimizan el coste del transporte y manipulación.

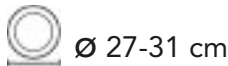

Código	Altura Máx cm	Capacidad Platos
1412-6	3,5	14
1412-6F1*	3,5	14

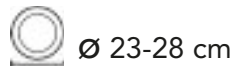

Código	Altura Máx cm	Capacidad Platos
1510-5	3,5	15
1510-5F1*	3,5	15

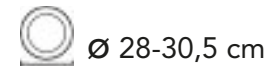

Código	Altura Máx cm	Capacidad Platos
1912-6	2,5	19
1912-6F1*	2,5	19

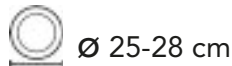

Código	Altura Máx cm	Capacidad Platos
2011-5	2,5	20
2011-5F1*	2,5	20

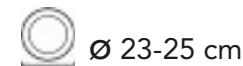

Código	Altura Máx cm	Capacidad Platos
2110-5	2,5	21
2110-5F1*	2,5	21



Código	Altura Máx cm	Capacidad Platos
3008-4	2,5	30
3008-4F1*	2,5	30

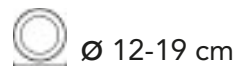

Código	Altura Máx cm	Capacidad Platos
3208-3	2,5	32
3208-3F1*	2,5	32

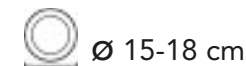

Código	Altura Máx cm	Capacidad Platos
4407-3	2	44
4407-3F1*	2	44

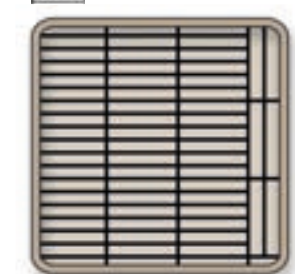

Código	Altura Máx cm	Capacidad Platos
6305-2	2,5	63
6305-2F1*	2,5	63

Cestas Bandejas



Cesta Bandejas isotérmicas Ref. 5050

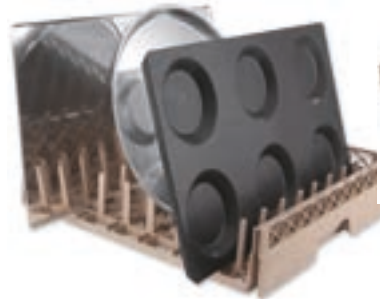

Cesta Grandes Bandejas Ref. 5030

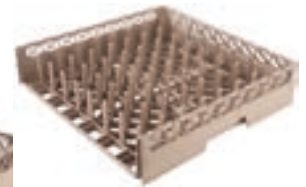

Carros Cestas

Carro Plástico



Código	Dimensiones (mm)
--------	------------------

5015	540x540x230
5017	540x540x980

Carro Inox



Código	Dimensiones (mm)
--------	------------------

8058	640x640x165
8059	640x640x1065



Código	Dimensiones (mm)
--------	------------------

8075	640x633x1160
8076	640x633x1710
8077	1185x633x1710

Cubetas herméticas



Hermético
Hermético



GASTRONORM



Etiqueta Permanente
Etiqueta Permanente



ColorClip



Fácil limpieza
Fácil limpeza



Regleta de medición
Régua de medição



Translúcido
Translúcido



Cubetas herméticas de Polipropileno

GN-1/9



Código	Dimensiones (mm)	Capacidad (lt)
3020	176x108x65	0,6
3021	176x108x100	1,0
3022	176x108x150	1,5

GN-1/6



Código	Dimensiones (mm)	Capacidad (lt)
3023	176x162x65	1,1
3024	176x162x100	1,8
3025	176x162x150	2,6

GN-1/4



Código	Dimensiones (mm)	Capacidad (lt)
3026	265x162x65	1,8
3027	265x162x100	2,8
3028	265x162x150	4,3

GN-1/3



Código	Dimensiones (mm)	Capacidad (lt)
3029	325x176x65	2,5
3030	325x176x100	4,0
3031	325x176x150	6,0

GN-1/2



Código	Dimensiones (mm)	Capacidad (lt)
3032	325x265x65	4,0
3033	325x265x100	6,5
3034	325x265x150	10,0
3035	325x265x200	12,5

GN-2/3



Código	Dimensiones (mm)	Capacidad (lt)
470	354x325x150	13,5
471	354x325x200	19,0

GN-1/1



Código	Dimensiones (mm)	Capacidad (lt)
3044	530x325x65	8,3
3036	530x325x100	13,7
3037	530x325x150	21,0
3038	530x325x200	28,0

Herméticos alérgenos

GN-1/6



GN-1/4



Código	Dimensiones (mm)	Capacidad (lt)
61390	176x162x150	2,6
61392	265x162x150	4,3
61393	325x175x150	6,0
61391	325x265x150	10,0

GN-1/3



GN-1/2



El color morado del hermético Araven identifica y diferencia el alimento de un cliente que padece alergia o intolerancias alimentarias para independizarlo del resto de contenedores y protegerlo de posibles contaminaciones de sustancias potencialmente alérgicas para él.

Cubetas policarbonato gn



Cubetas de policarbonato herméticas, con alta resistencia al impacto y medidas gastronorm para una perfecta modularidad.

Hermético		Alta resistencia al impacto	
GASTRONORM		Transparencia	
Etiqueta Permanente			
Cierre cubeta con cubeta			
Fácil limpieza			
Regleta de medición			
Ergonomía			



GN-1/6

Código	Dimensiones (mm)	Capacidad (lt)
--------	------------------	----------------

09796	176x162x65	1,0
09797	176x162x100	1,5
09798	176x162x150	2,1



GN-1/4

Código	Dimensiones (mm)	Capacidad (lt)
--------	------------------	----------------

09816	265x162x65	1,2
09817	265x162x100	2,2
09818	265x162x150	3,3



GN-1/3

Código	Dimensiones (mm)	Capacidad (lt)
--------	------------------	----------------

09808	325x176x65	1,6
09819	325x176x100	3,0
09820	325x176x150	4,7
09831	325x176x200	6,0



GN-1/2

Código	Dimensiones (mm)	Capacidad (lt)
--------	------------------	----------------

09821	325x265x65	3,9
09822	325x265x100	6,0
09823	325x265x150	9,5
09834	325x265x200	11,3



GN-1/1

Código	Dimensiones (mm)	Capacidad (lt)
--------	------------------	----------------

09826	530x325x65	8,3
09827	530x325x100	13,0
09828	530x325x150	19,6
09835	530x325x200	24,0



Tapas

Código	Modelo
--------	--------

09852	GN-1/6
09853	GN-1/4
09854	GN-1/3
09855	GN-1/2
09856	GN-1/1



Cubetas sin BPA



Cubetas de ABS libres de BPA para cumplir la normativa europea respecto al uso de Bisfenoles.

GN-1/6

Código	Dimensiones (mm)	Capacidad (lt)
--------	------------------	----------------

07796	176x162x65	0,75
07797	176x162x100	1,25
07798	176x162x150	1,90



GN-1/4

Código	Dimensiones (mm)	Capacidad (lt)
--------	------------------	----------------

07816	265x162x65	1,20
07817	265x162x100	2,20
07818	265x162x150	3,30



GN-1/3

Código	Dimensiones (mm)	Capacidad (lt)
--------	------------------	----------------

07808	325x176x65	1,65
07819	325x176x100	3,70
07820	325x176x150	4,70
07831	325x176x200	6,00



GN-1/2

Código	Dimensiones (mm)	Capacidad (lt)
--------	------------------	----------------

07821	325x265x65	3,90
07822	325x265x100	4,85
07823	325x265x150	7,90
07834	325x265x200	10,25



GN-1/1

Código	Dimensiones (mm)	Capacidad (lt)
--------	------------------	----------------

07826	530x325x65	6,25
07827	530x325x100	13,00
07828	530x325x150	19,60
07835	530x325x200	24,00



Tapas

Código	Modelo
--------	--------

09852	GN-1/6
09853	GN-1/4
09854	GN-1/3
09855	GN-1/2
09856	GN-1/1



Hermético de silicona



Directo al horno desde el congelador.

Código	Dimensiones (mm)	Capacidad (lt)
01802	GN-1/3 (325x175x100)	3,6
01803	GN-1/3 (325x175x150)	5,2
01804	GN-1/2 (325x265x100)	6,0
01805	GN-1/2 (325x265x150)	8,7
01806	GN-1/1 (530x325x100)	13,00
01807	GN-1/1 (530x325x150)	19,3

GN-1/2 (325x265x100)



GN-1/3 (325x175x150)



No usar la tapa en el horno

GN-1/1 (530x325x150)



Antiadherente

Conservación



ALMACENAJE

Tapas de silicona

Adaptables a herméticos de polipropileno, cubetas policarbonato y cubetas libres de BPA.



Código	Tipo	(mm)
91811	1/9	167x103
91812	1/6	167x154
91813	1/4	252x154
91814	1/3	109x167
91815	1/2	109x252
91816	2/3	336x309
91817	1/1	503x309

Cubetas gn - Inoxidables



PROFESSIONAL COOKWARE

- Ángulos y bordes reforzados.
- Apilables.
- Higiene y facilidad de almacenamiento.
- Totalmente modulares.

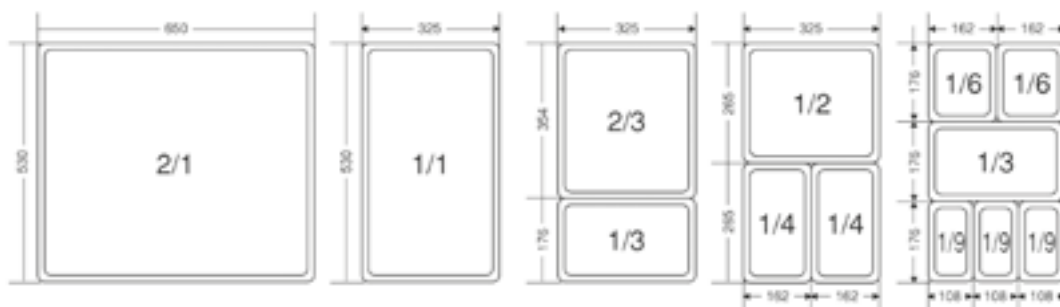

GN 2/1 - 650x530 mm



Código	h (mm)	(lt)
210201	65	6,25
210401	40	13,00
210651	62	19,60
211001	100	24,00
211501	150	43,10
212001	200	52,00

GN 1/1 - 530x325 mm



Código	h (mm)	(lt)
110201	20	2,80
110401	40	5,10
110551	55	7,00
110651	65	8,30
111001	100	14,20
111501	150	20,20
112001	200	26,00

GN 2/3 - 353x325 mm



Código	h (mm)	(lt)
230201	20	1,70
230401	40	3,10
230651	65	5,60
231001	100	8,80
231501	150	13,20
232001	200	18,30

GN 1/2 - 325x265 mm



Código	h (mm)	(lt)
120201	20	1,20
120401	40	2,20
120651	65	4,10
121001	100	6,10
121501	150	9,10
122001	200	12,00

GN 2/4 - 530x165 mm



Código	h (mm)	(lt)
240401	40	1,80
240651	65	4,00
241001	100	6,00
241501	150	10,00

GN 1/3 - 325x176 mm



Código	h (mm)	(lt)
130201	20	0,80
130401	40	1,50
130651	65	2,50
131001	100	3,80
131501	150	5,60
132001	200	7,30

GN 1/4 - 265x162 mm



Código	h (mm)	(lt)
140201	20	0,50
140651	65	1,80
141001	100	2,80
141501	150	4,10
142001	200	5,00

GN 1/6 - 176x162 mm



Código	h (mm)	(lt)
160651	65	1,00
161001	100	1,60
161501	150	2,20
162001	200	2,90

GN 1/9 - 176x108 mm



Código	h (mm)	(lt)
190651	65	0,60
191001	100	0,80

Cubetas gn perforadas

GN 2/1 - 650x530 mm



Código	h (mm)
--------	--------

210202	65*
210402	40*
210652	65*
211002	100**
211502	150**
212002	200**

GN 1/1 - 530x325 mm



Código	h (mm)
--------	--------

110202	20*
110402	40*
110552	55*
110652	65**
111002	100**
111502	150**
112002	200**

GN 2/3 - 353x325 mm



Código	h (mm)
--------	--------

230202	20*
230402	40*
230652	65*
231002	100**
231502	150**
232002	200**

GN 1/2 - 325x265 mm



Código	h (mm)
--------	--------

120652	65*
121002	100*
121502	150*
122002	200**

GN 1/3 - 325x176 mm



Código	h (mm)
--------	--------

130202	20*
130402	40*
130652	65*
131002	100**
131502	150**
132002	200**

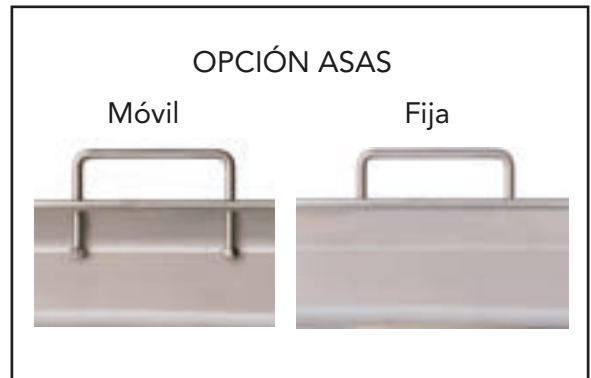

* Fondo perforado

** Fondo y laterales perforados

Cubetas gn fondo difusor

Sin asas



Con asas



Código	Tipo	h (mm)	(lt)
--------	------	--------	------

1104F1	1/1	40	5,10
1106F1	1/1	65	8,30
1110F1	1/1	100	14,20
1115F1	1/1	150	20,20
1204F1	1/2	40	2,20
1206F1	1/2	65	4,10
1210F1	1/2	100	6,10
1215F1	1/2	150	9,10

Código	Tipo	h (mm)	(lt)
--------	------	--------	------

1110F2	1/1	100	14,20
1115F2	1/1	150	20,20
1210F2	1/2	100	6,10
1215F2	1/2	150	9,10

Cubetas con fondo difusor adaptadas para la cocción en placa de inducción mediante fondo sandwich.



Tapas gn

Tamaño - Modelo	A	B	C	D	E
GN-1/1	110000	110004	110001	110002	1100P
GN-2/3	230000	-	230001	-	-
GN-1/2	120000	120004	120001	120002	1200P
GN-1/3	130000	130004	130001	130002	1300P
GN-1/4	140000	140004	140001	140002	1400P
GN-1/6	160000	160004	160001	160002	1600P
GN-1/9	190000	-	-	-	1900P



E - Tapa policarbonato Adaptable



A - Tapa normal



B - Tapa hermética



C - Tapa c/orificio asas



D - Tapa c/orificio asas y cucharón



Fondos perforados

Código	Tamaño
215000	GN-2/1
115000	GN-1/1
235000	GN-2/3
125000	GN-1/2
135000	GN-1/3
145000	GN-1/4



Perfiles divisorios

Código	Modelo	Tamaño	Longitud
111111	Perfil divisorio	GN-1/1	53,0 cm
122222	Perfil divisorio	GN-1/2	32,5 cm



Presentador cubetas

Código	Modelo	Tamaño
100004	Soporte sólo	680x150x115 mm
100005	Conjunto cubetas	6 GN-1/9 - 65 mm
100006	Conjunto cubetas	6 GN-1/9 - 100 mm
100007	Conjunto cubetas	4 GN-1/6 - 65 mm
100008	Conjunto cubetas	4 GN-1/6 - 100 mm



Contenedores cuadrados



Policarbonato

Código	Dimensiones (mm)	(lt)
91851	180x180x100h	2,0
91852	180x180x190h	4,0
91853	225x225x190	6,0
91854	225x225x230	8,0
91855	285x285x210	12,0
91856	285x285x320	18,0
91857	285x285x400	22,0



Polipropileno

Código	Dimensiones (mm)	(lt)
91860	180x180x100h	2,0
91861	180x180x190h	4,0
91862	225x225x190	6,0
91863	225x225x230	8,0
91864	285x285x210	12,0
91865	285x285x320	18,0
91866	285x285x400	22,0

ColorClip



Ergonomía



Fácil limpieza



Regleta de medición



Zona de protección



PC-Transparencia
PP-Translúcido



Permite el apilamiento



Cubetas sin tapa



1171 - 530x396x205 mm - 35 lts



1134 - 440x350x160 mm - 20 lts



1170 - 530x396x139 mm - 25 lts

Código	Dimensiones (mm)	(lt)
1134	440x350x160	20,0
1170	530x396x139	25,0
1171	530x396x205	35,0

Código	Dimensiones (mm)	(lt)
01133	540x365x80	10
01132	485x335x80	8
01131	435x285x80	5
01130	345x235x75	3
01129	300x205x60	2

Fondos perforados

Código	Dimensiones (mm)	Cubeta
01178	432x332x12	1170-1171
01182	375x300x12	1134-1133
01180	416x262x10	1132
01179	370x215x10	1131



Cubetas con tapa



01172 - 530x396x159 mm - 30 lt
Rejilla adaptable 01178



01173 - 530x396x225 mm - 40 lt
Rejilla adaptable 01178



01183 - 530x396x378 mm - 60 lt
Rejilla adaptable 01180
Con ruedas

Food Bacs



01850 - 600x395x410 mm - 50 lt



01870 - 655x435x455 mm - 70 lt
Con ruedas



01890 - 705x465x480 mm - 90 lt
Con ruedas

Contenedores accesibles



GN 1/3
09146
395x200x200 mm
7 lt



GN 2/3
09145
415x340x200 mm
16 lt

Contenedores accesibles FIFO

Sistema FIFO

First In ...
El primer alimento en almacenarse



First Out ...
El primer alimento en consumirse

GN 1/1



Código	Dimensiones (mm)	(lt)
00918	565x340x400	50,00
09144	565x340x200	22,65



Contenedores accesibles con ruedas

Etiqueta Permanente



ColorClip



Ergonomía



GASTRONORM



Fácil limpieza



Translúcido



Código	Dimensiones (mm)	(lt)
00919	655x435x560	80
00920	705x465x580	100



09469 - 140x100x250 mm - 190 cl



09459 - 330x160x140 mm - 95 cl



09455 - 250x80x70 mm - 18 cl



09265 - 280x120x116 mm - 60 cl

Carros

Carro servicio

Código	Medidas (mm)	Medidas estante (mm)	Nº estantes
F0260401	895x595x950	800x500	2
F0260402	995x595x950	900x500	2
F0260403	1095x595x950	1000x600	2
F0260404	895x595x950	800x500	3
F0260405	995x595x950	900x500	3
F0260406	1095x595x950	1000x600	3
F0260407	995x595x950	900x500	4
F0260408	1095x595x950	1000x600	4



Carro cestas

Código	Modelo	Tamaño (mm)
F0260001	Carro Cestas	520x520x250
F0260101	Carro Cestas C/Asa	731x634x1050
F0261701	Carro Cestas Guías	700x630x1700



- Construidos en acero inox AISI 304 18/10.
- 4 ruedas 125 mm ø.
- 7 niveles.
- Espacio entre nivele: 201 mm.



Sobremesa

- Capacidad:
 - 20 platos ø 200-320 mm.
 - 30 platos ø inferior 200 mm.
- Construido en acero inox ANSI 304 18/10.
- 10 niveles.
- Dimensiones: 575x320x855 mm.

Carro emplatar

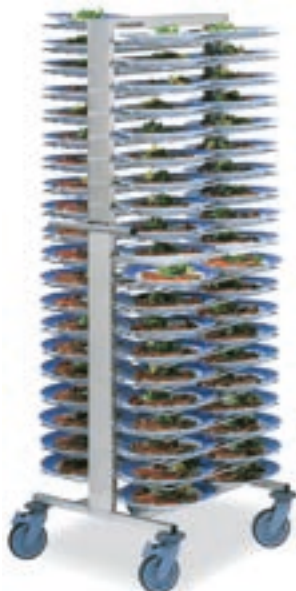

- Capacidad:
 - 80 platos ø 200-320 mm.
 - 120 platos ø inferior 200 mm.
- Construido en acero inox ANSI 304 18/10.
- 4 ruedas giratorias 125 mm ø (2 con freno).
- 20x2 niveles.
- Espacio entre niveles: 70 mm.
- Dimensiones: 630x665x1750 mm.
- Rejillas de medidas 540x273 mm en acero inox.



funda carro

Carro bandeja

Código	Modelo	Medidas estante	Medidas bandeja
F0260601	GN-1/1	460x630x1700	530x325 (GN-1/1)
F0260901	GN-2/1	660x750x1700	650x530 (GN-2/1)
F0261001	Pastelero	540x700x1700	600x400 (Pastelera)



Modelo GN



Modelo Pastelero

- Construido en acero inox ANSI 304 18/10.
- Desmontable.
- 4 ruedas giratorias 125 mm \varnothing (2 con freno).
- 15 niveles con 89 mm de separación.

Carro universal

Código	Modelo	Medidas (mm)	Niveles
F0261201	SIMPLE	510x640x1690	12 niveles
F0261101	DOBLE	930x640x1690	12+12 niveles

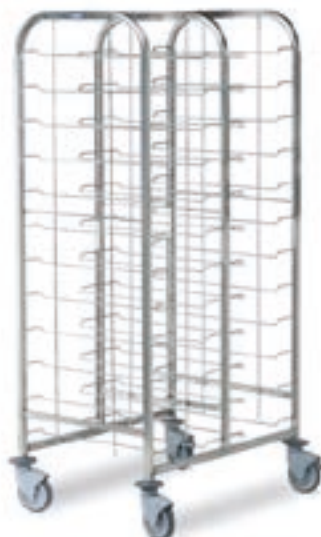
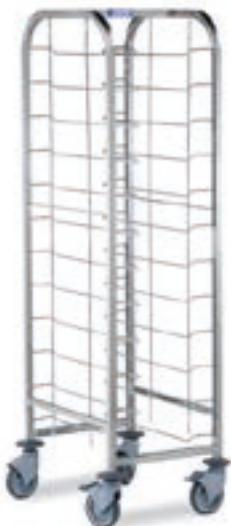

- Construido en acero inox ANSI 304 18/10.
- 4 ruedas giratorias 125 mm \varnothing (2 con freno).
- Dimensión máxima de bandeja: 530x370 mm.
- Espacio entre niveles: 112 mm.

Estanterías modulares



Sin tornillería, sistema de montaje con anclajes que permite ahorrar tiempo de instalación

- Homologadas con la certificación NF de higiene alimentaria.
- Facilidad de montaje mediante anclajes.
- Diseñadas especialmente para su colocación en cámaras frigoríficas.
- Parrillas autoventiladas y lavables en lavavajillas.
- 2 profundidades: 370 y 470 mm. Medida gastronorm.
- 2 alturas:
 - 1700 mm (10 alturas regulables cada 150 mm).
 - 2000 mm (12 alturas regulables cada 150 mm).



Detalle pieza anclaje



Ruedas opcionales con freno

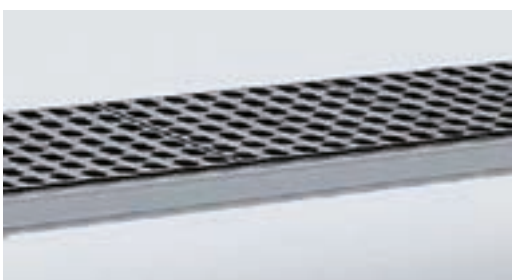

- Construidas totalmente en polipropileno alimenticio de alta densidad.
- Fácil montaje.
- Parrillas de ancho 370 y 470 mm.

BUFFET Y CATERING

*Buffet and Catering • Buffet et de restauration
Buffet e Ristorazione • Buffet-Catering*



Buffet 5 Estrellas / Classic

Destinado a buffets modernos y de tendencia. 2 acabados: **5 estrellas** lacado blanco, de alta resistencia, es ideal para ambientes lujosos y de alto nivel.

Classic en wengué. Ambos han sido realizados con materiales certificados, adecuados a los alimentos, y de fácil mantenimiento y limpieza. Todos aquellos elementos destinados a mantener el calor, están protegidos por una placa de acero, y se caracterizan por su cierre a fricción.

BUFFET CALIENTE. Mantienen los alimentos a una temperatura óptima. Disponibles en versión tradicional (con hornillos inox adecuados para contener alcohol en gel) y opcional (con resistencia eléctrica regulable de 7 posiciones. 700 W). Todos los modelos incluyen: 1 cubeta baño maría GN 1/1 h110mm (bollería h20mm); 2 quemadores con soporte; 1 base alta en MDF con placa superior de protección inox 18/10.



BUFFET FRÍO. Mantienen los alimentos a baja temperatura (4 a 15°C). El enfriamiento puede alcanzarse con las bolsas gel (previo enfriamiento en el congelador) o con hielo. Base baja o expositores a 2 ó 3 alturas en MDF. Los modelos refrigerados incluyen 2 fondos perforados GN 1/2 PC y 2 gel pack 20x19 cm.

PINTI buffet MADE IN ITALY



Chafing Disch rectangular
Cierre fricción

Referencia	Medidas (mm)
------------	--------------

51135555	640x460x300
511B5555	640x460x300



Sopera 2 estaciones
Capacidad cubeta 5 L

Referencia	Medidas (mm)
------------	--------------

51135556	640x460x260
511B5556	640x460x260



Portaverduras 4 compartimentos
Cubeta GN 1/4 65 mm

Referencia	Medidas (mm)
------------	--------------

51132810	640x460x300
511B2810	640x460x300



Bandeja caliente para bollería
Con resistencia eléctrica

Referencia	Medidas (mm)
------------	--------------

51130930	640x460x390
511B0930	640x460x390



Bandeja refrigerada para fiambres

Referencia	Medidas (mm)
------------	--------------

51130950	640x460x300
511B0950	640x460x300



Bandeja refrigerada para yogurt
22 ud.

Referencia	Medidas (mm)
------------	--------------

51132900	640x460x12,2
511B2900	640x460x12,2



Bandeja refrigerada yogurt y verduras
3 cubetas 1/3 Policarbonato

Referencia	Medidas (mm)
------------	--------------

51132840	640x460x12,2
511B32840	640x460x12,2



Bandeja refrigerada para jarras
Incluye 3 jarras

Referencia	Medidas (mm)
------------	--------------

51131A00	640x460x12,2
511B1A00	640x460x12,2



Bandeja refrigerada para 8 botellas

Referencia	Medidas (mm)
------------	--------------

51133700	640x460x12,2
511B3700	640x460x12,2



Bandeja refrigerada doble
2 bandejas GN 1/1

Referencia	Medidas (mm)
------------	--------------

51131055	590x460x460
511B1054	590x460x460



BUFFET NEUTRO. Mantenimiento neutro de la temperatura.



Bandeja para quesos
1 bandeja GN 1/1

Referencia	Medidas (mm)
------------	--------------

51130940	640x460x300
511B0940	640x460x300



Bandeja para el pan
Cesto polirattan GN 1/1

Referencia	Medidas (mm)
------------	--------------

51136900	640x460x370
511B6900	640x460x370



Bandeja para champagne
2 cubos 7 litros (22 cm)

Referencia	Medidas (mm)
------------	--------------

51132600	640x460x210
511B2600	640x460x210



Bandeja para cortar pan

Referencia	Medidas (mm)
------------	--------------

51136800	640x460x162
511B6800	640x460x162



Bandeja para fruta
2 bandejas GN 1/1

Referencia	Medidas (mm)
------------	--------------

51131056	590x460x330
511B1056	590x460x330



Presentador 3 pisos
3 bandejas GN 2/3 Refrigeradas

Referencia	Medidas (mm)
------------	--------------

51131058	380x730x630
511B1058	380x730x630

* Cúpula opcional

Dispensadores 5 Estrellas / Classic

Al servicio de la restauración moderna.



Dispensador zumos y bebidas 9,5 L
Tubo para hielo

Referencia	Medidas (mm)
------------	--------------

51135420	250x460x670
511B5420	250x460x670

Dispensador zumos y bebidas 4,5 L
Tubo para hielo

Referencia	Medidas (mm)
------------	--------------

51135413	250x460x600
511B5413	250x460x600



Dispensador de cereales 8 L
Simple

Referencia	Medidas (mm)
------------	--------------

51139818	250x460x660
511B9818	250x460x660



Dispensador de cereales 8 L
Doble

Referencia	Medidas (mm)
------------	--------------

51139819	510x460x660
511B9819	510x460x660



Dispensador doble zumos y bebidas 4,5 L
Tubo para hielo

Referencia	Medidas (mm)
------------	--------------

51135416	250x460x600
511B5416	250x460x600



Dispensador bebidas calientes 8 L
Con resistencia eléctrica

Referencia	Medidas (mm)
------------	--------------

51139527	250x460x610
511B9527	250x460x610

Base para 36 cuencos Ø 6 cm

Referencia	Medidas (mm)
------------	--------------

51130799	190x100x260
9715B799	190x100x260

Base para 24 cuencos Ø 12 cm

Referencia	Medidas (mm)
------------	--------------

51130798	190x100x260
9715B798	190x100x260



PINTIbuffet
MADE IN ITALY

Buffet y Catering

Línea Buffet Cubic

Cubos, estantes y bandejas que forman composiciones modulares, cómodas y funcionales. Original y versátil. Múltiples combinaciones posibles. Madera con tratamiento hidrófugo especial. En blanco o negro. Combinables. Presentaciones en buffet elegantes y originales. Fácil limpieza.



Conjunto
2 cubos con tapa + 1 travesaño de 100 cm
+ 1 presentador 6 bols + 6 bols melamina

Referencia **Medidas (cm)**

P905.506 141x49x17



Conjunto
2 cubos con tapa + 1 travesaño de 50 cm +
1 presentador 4 bols + 4 bols melamina

Referencia **Medidas (cm)**

P905.504 90x49x17



Conjunto
2 cubos con tapa + 1 travesaño de 80 cm +
2 presentadores 4 bols + 4 bols melamina

Referencia **Medidas (cm)**

P905.508 121x49x17



Conjunto
4 cubos con tapa + 1 travesaño de 100 cm + 1 presentador
6 bols + 6 bols melamina + 1 estante de 100 cm

Referencia **Medidas (cm)**

P905.516 141x49x31,5



Dispensador zumos 6 L

Referencia **Medidas (cm)**

P904.800 23x39x49



Conjunto
4 cubos con tapa + 1 estante 100 cm +
estante estrecho 100 cm

Referencia **Medidas (cm)**

P905.400 141,5x31,5x35



Conjunto
6 cubos con tapa + 1 estante ancho 100 cm + estante estrecho
100 cm + 1 estante ancho 80 cm + 1 estante estrecho 80 cm

Referencia **Medidas (cm)**

P905.410 141,5x121,5x31,5



Expositor GN 2/3 3 niveles
Incluye 3 cubetas inox GN 2/3 2 cm

Referencia **Medidas (cm)**

P904.790 65x38x59



Conjunto
4 cubos con tapa + 1 travesaño 100 cm +
2 bandejas presentación 40x40

Referencia **Medidas (cm)**

P905.300 141x39x31,5

Conjunto
6 cubos con tapa + 1 travesaño 100 cm + 2 bandejas
presentación 60x40 cm + un estante estrecho 100 cm

Referencia **Medidas (cm)**

P905.340 141x60x46



Conjunto
2 cubos con tapa + 1 travesaño 100 cm +
2 bandejas presentación 60x40

Referencia **Medidas (cm)**

P905.320 141x60x17



Conjunto
2 cubos con tapa + 1 travesaño 50 cm + 1 bandeja
presentación 60x40 cm + kit completo dispensador zumos

Referencia **Medidas (cm)**

P905.200 121x39x48





Bandeja porta cubiertos

Referencia	Medidas (mm)
------------	--------------

P904.780	539x335x77
* Apilable	



Bandeja servicio y presentación GN 1/1

Referencia	Medidas (mm)
------------	--------------

P904.711	600x400x65
* Apilable	



Bandeja presentación

Referencia	Medidas (mm)
------------	--------------

P904.740	400x400x65
* Apilable	



Bandeja servicio y presentación

Referencia	Medidas (mm)
------------	--------------

P904.760	600x400x65
* Apilable	

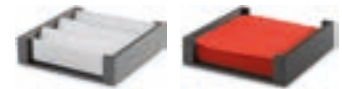

Servilletero y dispensador bolsas té y azúcar

Referencia	Medidas (mm)
------------	--------------

P904.720	220x220
P904.725	220x220



Enfriador botellas buffet

Referencia	Medidas (mm)
------------	--------------

P904.155	570x370x145
----------	-------------

Mesita buffet GN 1/1 + taco madera

Referencia	Medidas (mm)
------------	--------------

P904.850	530x325x120
----------	-------------



Mesita buffet baja + taco madera

Referencia	Medidas (mm)
------------	--------------

P904.810	325x220x120
P904.820	325x220x165
P904.890	325x220x210



Buffet pan

Referencia	Medidas (mm)
------------	--------------

P904.145	570x370x145
P904.145W	570x370x145



Buffet triple

Referencia	Medidas (mm)
------------	--------------

P904.113	570x370x310
P904.113W	570x370x310

Buffet cubiertos

Referencia	Medidas (mm)
------------	--------------

P904.150	570x370x255
P904.150W	570x370x255



Buffet melamina

Referencia	Medidas (mm)
------------	--------------

P904.160	570x370x145
P904.160W	570x370x145



Buffet estandar

Referencia	Medidas (mm)
------------	--------------

P904.165	570x370x310
P904.165W	570x370x310



Enfriador botellas caja madera

Referencia	Medidas (mm)
------------	--------------

P904.157	325x265x150
----------	-------------



Buffet quesos

Referencia	Medidas (mm)
------------	--------------

P904.140	570x370x310
P904.140W	570x370x310



Soporte pincho estante

Referencia	Medidas (mm)
------------	--------------

P904.360	448x182
P904.361	748x182



Bandeja cuadrada pinchos

Referencia	Medidas (mm)
------------	--------------

P904.351	220x215x40
----------	------------



Bandeja GN pinchos

Referencia	Medidas (mm)
------------	--------------

P904.350	530x325x77
----------	------------



Buffet Compact



Perfecto para Bed & Breakfast, Agriturismo, Garni, Hoteles y Hoteles Boutique. Ahorro de espacio, versátil y elegante son sólo algunos de los adjetivos para describir esta línea especialmente creado para el desayuno, que puede caber fácilmente en muchos lugares diferentes.

- Las bases y los marcos son de madera revestida que son resistentes a los arañazos, a los impactos y resistente a las manchas.
- Las cloches PET son elegantemente transparentes, apilables y resistentes al impacto del uso diario.



Estación dulce salado

1 estructura + 2 cestas GN 1/3 + 3 cúpulas + 2 cubetas GN 1/2 inox + 1 pack gel refrigerante

Referencia	Medidas (mm)
51602400	500/1260x420x330



Estación refrigerada multiuso 3 huecos

1 estructura + cubeta PP + 1 pack gel refrigerante

Referencia	Medidas (mm)
51600900	405x160x120



Estación bol refrigerado multiuso

1 estructura + 1 tapa Ø 23 cm abatible + tapa perforada 24 cm + 1 bol vidrio 23 + 1 rejilla + cúpula Ø 24 cm.

Referencia	Medidas (mm)
51602400	500/1260x420x330



Servilletero

Referencia	Medidas (mm)
51604300	215x215x65



Cajón multiusos 4 departamentos

Referencia	Medidas (mm)
51604600	300x300x60



PINTIbuffet
MADE IN ITALY

Retermalizadores y calentadores

Retermalizadores

Calentar y mantener alimentos a la temperatura deseada. Incluso permite calentar comidas salidas directamente del refrigerador en menos de 90 minutos.



Estilo Retro

Calienta con agua la comida fría hasta una temperatura deseada en menos de 90 minutos.

El cuerpo exterior no se calienta durante el uso.

Referencia	Capacidad	Medidas (cm)
------------	-----------	--------------

7217810	6,6 L	Ø 41,9x34,3
72178835	6,6 L	Ø 41,9x34,3
7217850	6,6 L	Ø 41,9x34,3
7217855	6,6 L	Ø 41,9x34,3
7217860	6,6 L	Ø 41,9x34,3
7217310	10,10 L	Ø 41,9x34,3
7217335	10,10 L	Ø 41,9x34,3
7217350	10,10 L	Ø 41,9x34,3
7217355	10,10 L	Ø 41,9x34,3
7217360	10,10 L	Ø 41,9x34,3



Mirage 3D inducción

Calentamiento por inducción (sin agua).

Reduce el coste energético.

Control de temperatura fácil y seguro.

Tiempos de rethermalización rápidos.

Arranque inmediato, sin precalentar.

Referencia	Capacidad	Medidas (cm)
------------	-----------	--------------

7470210	6,6 L	Ø 30,3x34,2x17,6
7074240	6,6 L	Ø 30,3x34,2x17,6
74110210	10,4 L	Ø 35,3x34,2x17,6
74110240	10,4 L	Ø 35,3x34,2x17,6



Cazillos Ergogrip

Acero inoxidable.

Asas revestidas de plástico que resisten 82°C

Referencia	Capacidad	Medidas (cm)
------------	-----------	--------------

4980322	88,7 ml	Ø 7,3x33
4980422	118,3 ml	Ø 7,9x33
4980622	177,4 ml	Ø 8,6x33
4980822	236,6 ml	Ø 10,3x36

Calentadores

Mantener calientes las comidas preparadas.



Ollas

475 W - 10,10 L

Referencia	Medidas (cm)
------------	--------------

HIERRO ESMALTADO 69037	Ø 34,5x36
ACERO INOXIDABLE 69038	Ø 34,5x36

Calentador

800 W - 11 L

Referencia	Medidas (cm)
------------	--------------

69267	Ø 33x32
-------	---------



Olla

550 W - 80°C - 10 L

Referencia	Medidas (cm)
------------	--------------

11901	Ø 38x36
11902	Ø 38x36

Chafing Dish



Chafer Inducción Intrigue

Tapas removibles con bisagra de cierre lento.
3 ángulos de apertura, cerrada, 45° o 90°.

Tapa y cubeta con sistema antigoteo, mantienen la condensación fuera del alimento.



Chafing Dish redondo

Referencia	Descripción	Medidas (cm)
46123	Tapa acero inoxidable	39,4x8 - 5,8 L
46125	Tapa cristal	39,4x8 - 5,8 L



Chafing Dish cuadrado

Referencia	Descripción	Medidas (cm)
46132	Tapa acero inoxidable	39,2x39,2x4,12 - 5,8 L
46134	Tapa cristal	39,2x39,2x4,12 - 5,8 L



Soporte Chafing

Referencia	Descripción
46114	Redondo
46113	Cuadrado



Fuente interior redonda

Referencia	Descripción	Medidas (cm)
46130	Porcelana	39,4x71
49130	Porcelana dividida	39,4x71
49131	Acero inoxidable	39,4x71

Fuente interior cuadrada

Referencia	Descripción	Medidas (cm)
46136	Porcelana	39,4x38,8x52
49136	Porcelana dividida	39,4x38,8x52
46137	Acero inoxidable	39,4x38,8x52



Calentador eléctrico universal
Encaja en el orificio para el combustible estándar

Referencia

46110

Mirage calentadores de inducción

Diseño atractivo y sutil, se pueden conectar hasta 3 placas a la vez.

Parte superior de cristal templado negro.

Con 4 ajustes de potencia.

Indicadores luminosos LED en el panel de control.

Placa inducción mantenedora Mirage
300 W

Referencia	Medidas (cm)
595027502	40,6x40,6x9,8





Tapa con descenso amortiguado para un cierre suave.
Tapa extraíble verticalmente para su limpieza.
Las gotas de condensación retornan a la cubeta.
Disponibilidad de aro complementario para el empleo de placa de inducción.



Chafing Dish GN 1/1

Referencia	Descripción	Medidas (cm)
------------	-------------	--------------

69091	Completo	47x59,5x25 - 9 L
69099	Cuerpo	47x59,5x25 - 9 L
69089	Soporte	47x59,5x25 - 9 L



Chafing Dish GN 2/3

Referencia	Descripción	Medidas (cm)
------------	-------------	--------------

69092	Completo	43x46x25,5 - 5,5 L
69095	Cuerpo	43x46x25,5 - 5,5 L
69087	Soporte	43x46x25,5 - 5,5 L



Chafing sopa

Referencia	Descripción	Medidas (cm)
------------	-------------	--------------

69098	Completo	Ø 45x38 - 11,6 L
69100	Cuerpo	Ø 45x38 - 11,6 L
69097	Soporte	Ø 45x38 - 11,6 L



Chafing redondo

Referencia	Descripción	Medidas (cm)
------------	-------------	--------------

69101	Completo	46x53x25 - 6 L
69096	Cuerpo	46x53x25 - 6 L
69097	Soporte	46x53x25 - 6 L



Accesorios

Placa inducción para
69091/69092/69098/69101

Referencia

69131

Aro completo para inducción

Referencia

Para 69091/69092 R69099B

Para 69098/69101 R69100B

Salsera 12x23x4 cm R69099C



Chafing Dish GN 1/2

Referencia	Descripción	Medidas (cm)
------------	-------------	--------------

69093	Completo	32,5x46x25,5 - 4L
69094	Cuerpo	32,5x46x25,5 - 4L
69088	Soporte	32,5x46x25,5 - 4L
R69094A	Aro placa	32,5x46x25,5 - 4L
69139	Placa inducción	32,5x46x25,5 - 4L



Chafing eléctricos



Eco GN 1/1
900 W

Referencia	Medidas	Capacidad
12232	63x36x29 cm	9 L



Eco redondo
500 W

Referencia	Medidas	Capacidad
12221	Ø 36x25 cm	6,8 L



Elite GN 1/1
900 W

Referencia	Medidas	Capacidad
12360	67x47x45 cm	14 L

Chafing económicos



Referencia	Medidas	Capacidad
P379.065	65x35x34 cm	9,5 L



Referencia	Medidas	Capacidad
P379.500	65x35x32 cm	9 L



Referencia	Medidas	Capacidad
P387.065	65x38x39 cm	9,5 L

Chafing bebidas calientes



Royal

Referencia	Medidas	Capacidad
11667	28x28x65 cm	12 L



Happy Hour

Referencia	Medidas	Capacidad
11672	31x33,6x54,5 cm	10,5 L



Complementos

Placa eléctrica Chafing
bebidas
500 W

Referencia

12287

Calentadores eléctricos
para chafing
700 W

Referencia

Con regulador 69002

Sin regulador 69012



Contenedor
combustible

Referencia

69006

Lata Gel combustible
Etanol

Referencia Capacidad

69108 225 gr



Cubo Gel
Etanol

Referencia Capacidad

69109 4 kg



Bidón
Metanol

Referencia Capacidad

69109 4 kg



Lámparas calentamiento infrarrojos



Estación Buffet trinchante
Bombilla infrarrojos, blanca 250 W

Referencia **Medidas (cm)**

46671 60x55x66



Tabla de corte

Color negro

Referencia **Medidas (cm)**

25154 54x42x1,27



Lámpara cable extensible

Referencia **Medidas** **Potencia**

69266 24x24x35 cm 275 W



Referencia **Medidas** **Potencia**

Doble 69061 36x45x61 cm 550 W
Simple 69361 34x33x56 cm 275 W

Referencia **Medidas** **Potencia**

Simple 69263 79x31x23 cm 275 W
Doble 69264 76x36x36 cm 550 W

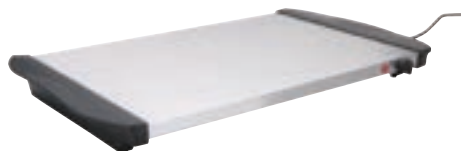

Placa calentamiento eléctrica
400 W - Rango Temp 0° - 80°C

Referencia **Medidas (cm)**

69045 36x45x61



Luxe inox

Referencia **Medidas** **Potencia**

2 ranuras 69162 32x18x19 cm 850 W
4 ranuras 69164 32x26x19 cm 1400 W



Tostador horizontal

Referencia **Medidas** **Potencia**

1 piso 69172 50x25x38 cm 2400 W
2 pisos 69173 50x25x38 cm 3600 W



Fuentes chocolate

Referencia **Medidas (cm)**

Torre 18 cm 69318 Ø 16x30
Torre 38 cm 69319 Ø 23x54,5



Tostador cinta

Referencia **Medidas** **Potencia**

PRODUCCIÓN 150 h 69065 53x37x40 cm 1340 W
PRODUCCIÓN 300 h 69066 53x45x40 cm 2240 W

Dispensadores de Bebidas



Airpot eléctrico
Agua-café-Leche Capacidad: 5,20 L

Referencia Medidas (cm)

69475 Ø 28x37



Chocolatera eléctrica
Capacidad: 5 L

Referencia Medidas (cm)

N4905 Ø 48,5x32



Samovar eléctrico
Capacidad: 3 L Incluye tetera 0,60 L

Referencia Medidas (cm)

N5062 Ø 21x47

Top Fresh

Enfrían por abajo y por arriba con acumuladores de frío, manteniendo el zumo y la leche frío y seco.



Botella cristal enfriadora

Referencia Medidas (cm)

1,4 L 10762 Ø 16x27



10771 10772 10773 10774

Botellas policarbonato

Medidas (cm) Capacidad

Ø 16x27 1,6 L

Referencia

10771
10772
10773
10774



Dispensadores leche
Cuba Porcelana

Referencia Medidas (cm)

4 Litros 10850 31x21x42
Cuba acero inoxidable
3 Litros 10830 31x21x42
5 Litros 10750 31x21x42

Mixto zumo leche

6+5 Litros 10760 42x32x52



Dispensador de zumo

Referencia Medidas (cm)

4 Litros 10800 21x32x43
6 Litros 10700 23x35x52
2x6 Litros 10720 42x32x52



Jarras acrílicas
Con tubo para hielo

Referencia Capacidad

10770 3 L
10769 2,4 L



Referencia Capacidad

10776 2,5 L
10775 2 L

Dispensador de cereales

Inox Star

Económico, con tubo refrigerante para el hielo
Cuba SAN.



Dispensador de zumo

Referencia	Medidas (cm)
------------	--------------

8 Litros	10795	36x26x55
2x6 Litros	10810	36x52x55

Fresh & Easy

Acero inoxidable y cuba en policarbonato.
Tapa especial para mantener los cereales frescos, fácil de usar.
Económico.



Referencia	Medidas	Capacidad
------------	---------	-----------

SIMPLE	11805	22x17,5x52 cm	4,5 L
DOBLE	11807	22x35x52 cm	2x4,5 L



Dispensadores de bebidas
Incluye difusor frío y base

Referencia	Capacidad
------------	-----------

75	9,5 L
85	19 L

Incluye difusor frío

Referencia	Capacidad
------------	-----------

DISPENSADOR	BDG1000	9,5 L
BASE	BDGTUB	9,5 L



Good Morning

Set madera con 2 botes cierre hermético 2 L

Referencia	Medidas (cm)
------------	--------------

13965	43x17	
14965	43x17	

Classic

Acero inoxidable 18/10 y cuba en policarbonato. Tapa hermética. Calidad extra.



Referencia	Medidas	Capacidad
------------	---------	-----------

SIMPLE	11833	32x26,5x68 cm	8 L
DOBLE	11834	32x50x68 cm	2x8 L



Referencia	Medidas	Capacidad
------------	---------	-----------

B898028	Ø 22x29,5 cm	8 L
B898029	Ø 19x24 cm	5 L



Referencia	Medidas	Capacidad
------------	---------	-----------

B898007	18x18x32 cm	8 L
B898008	15x15x26 cm	4 L

Rotation

Giratorio. Acero inoxidable 18/10 y cuba en policarbonato. Tapa hermética. Calidad extra.



Referencia	Medidas	Capacidad
------------	---------	-----------

11970	Ø 38x54 cm	3x4,5 L
-------	------------	---------

Cereal Bar

Jarra SAN 1,5 L con tapa acero inoxidable. Stand acrílico con 2 alturas para presentaciones.



Referencia	Medidas	Capacidad
------------	---------	-----------

11971	26x17x28,5 cm	2x1,5 L
11972	26x17x32,5 cm	2x1,5 L
11973	38x17x28,5 cm	3x1,5 L
11974	38x17x32,5 cm	3x1,5 L



Soporte en acero inoxidable
3 Bols vidrio 3 tapas acrílica con bisagra

Referencia	Medidas	Bol
BIG 11892	50x50x18 cm	Ø 23 cm
LITTLE 11893	30x30x14 cm	Ø 14 cm

Boles opcionales

Referencia	Bol
83702	Ø 23 cm <input type="checkbox"/>
83703	Ø 23 cm <input checked="" type="checkbox"/>
83700	Ø 14 cm <input type="checkbox"/>
83701	Ø 14 cm <input checked="" type="checkbox"/>



Sunday

Soporte metálico
Bols vidrio 23 cm con tapa policarbonato con bisagra

Referencia	Medidas (cm)
------------	--------------

1 bol	11794	Ø 24x17
3 bols	11795	61x24x35



Soporte en acero inoxidable
4 Bols con tapa acrílica con bisagra

Referencia	Medidas	Bol
------------	---------	-----

11958	39x31x55 cm	Ø 23 cm
11498	30x30x48 cm	Ø 14 cm



Soporte en acero inoxidable
6 Bols sin tapa

Referencia	Medidas	Bol
------------	---------	-----

11599	39x31x55 cm	Ø 23 cm
11499	30x30x48 cm	Ø 14 cm

Dispensadores



Rack para Bols
Metálico

Referencia	Medidas	Bol
------------	---------	-----

MINI	11980	Ø 14x25,5 cm	36xØ 6 cm
MEDIUM	11990	Ø 17x25,5 cm	36xØ 7,5 cm
MAXI	11992	Ø 17,5x36,5 cm	15xØ 14 cm



Multi-Rack

Acero inoxidable 18/10 Bols SAN

Referencia	Medidas
------------	---------

2 alturas	11442	19x24x28 cm
3 alturas	11444	19x24x41 cm
4 alturas	11451	19x31x53 cm

Soportes



Star
Metálico

Referencia **Medidas (Altura)**

33260	8 cm
33261	12 cm
33262	18 cm



King

Metal cromado.
Antideslizante en puntas de brazos.
Alta calidad. Base para reposar cucharas.

Referencia **Medidas**

03622	Ø 15x14 cm
03623	Ø 15x21 cm



Multi
Metálico

Medida: 18x18 cm

Referencia **Medidas (Altura)**

33250	8 cm
33251	10 cm
33252	18 cm

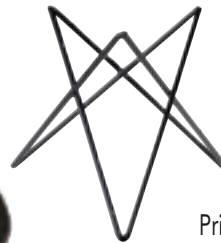

Prisma
Metálico

Medida: 26 cm

Referencia **Medidas (Altura)**

33272	10,5 cm
33273	20 cm

Wood
Madera
2 posiciones
Medidas: 20x20x17,5

Referencia

33280	
33281	



Soporte Weck
Metal cromado

Referencia **Medidas**

6 Tarros	33247	Ø 22x33 cm
12 Tarros	33246	Ø 22x59 cm

Referencia **Medidas** **Capacidad**

82370	Ø 6x5,5 cm	0,08 L
82371	Ø 6x8 cm	0,16 L



Para bols Float 83916/83917

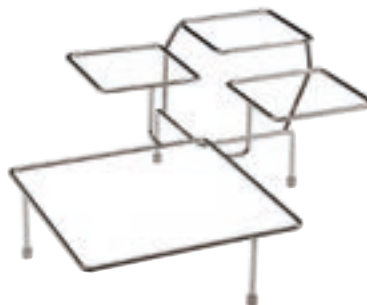

Para bols Float 83914/83915



Soporte Float
Metal cromado

Referencia **Medidas**

SMALL	33241	55,5x19x15,5 cm
BIG	33242	39x39x17 cm

Baskets



15326 Cesta negra

Referencia	Medidas (cm)
15326	Ø 21/15x21



15332 Cesta/soporte plata brillo

Referencia	Medidas (cm)
15331	Ø 15/21x10,5
15332	Ø 21/20x20



15335 Cesta/soporte oro mate

Referencia	Medidas (cm)
15334	Ø 15/21x10,5
15335	Ø 21/20x20



15322 Cesta/soporte

Referencia	Medidas (cm)
15320	Ø 10,5/8x8
15324	Ø 10,5/8x8
15322	Ø 10,5/8x8



15321 Cesta/soporte

Referencia	Medidas (cm)
15321	Ø 21/15x21
15325	Ø 21/15x21
15323	Ø 21/15x21

Asia +



Buffet Stand

Referencia	Medidas (cm)
GN 1/1 15501	53x32x16,2
GN 1/2 15502	32,5x26,5x16,2
GN 2/3 15503	32,5x17,5x32,5

Referencia	Medidas (cm)
GN 1/1 15504	53x32x16,2
GN 1/2 15505	32,5x26,5x16,2
GN 2/3 15506	32,5x17,5x32,5

Buffet Stand

Referencia	Medidas (cm)
15513	Ø 20x16,5
15514	Ø 20/16,5



Referencia	Referencia	Referencia	Tapa	Medidas (cm)
15400	15408	15416		Ø 7,5
15401	15409	15417		Ø 9,5
15402	15410	15418		Ø 13
15403	15411	15419	15340	Ø 16
15404	15412	15420	15341	Ø 20
15405	15413	15421	15342	Ø 24
15406	15414	15422	15343	Ø 26,5
15407	15414	15423	15344	Ø 32,5



Referencia	Referencia	Referencia	Tapa	Medidas (cm)
15400	15408	15416		Ø 7,5
15401	15409	15417		Ø 9,5
15402	15410	15418		Ø 13
15403	15411	15419	15340	Ø 16
15404	15412	15420	15341	Ø 20
15405	15413	15421	15342	Ø 24
15406	15414	15422	15343	Ø 26,5
15407	15414	15423	15344	Ø 32,5



15512 Buffet Stand

Referencia	Medidas (cm)
15509	Ø 21x20
15512	Ø 21/20

15509	Ø 21x20
15512	Ø 21/20



15508 Buffet Stand

Referencia	Medidas (cm)
15508	Ø 21x10,5
15511	Ø 21/10,5

15508	Ø 21x10,5
15511	Ø 21/10,5

Referencia	Referencia	Referencia	Medidas (cm)
15424	15429	15434	Ø 11
15425	15430	15435	Ø 16
15426	15431	15436	Ø 19,5
42427	15432	15437	Ø 24
15428	15433	15438	Ø 28





Tapas
Policarbonato

Referencia	Medidas (cm)
------------	--------------

GN 1/1 11042	53x32x9,5
GN 1/2 11041	32,5x26,5x9,5



Tapa
Poliestileno

Referencia	Pomo	Medidas
------------	------	---------

06510	Transparente	Ø 30x11 cm
06511	Negro	Ø 30x11 cm
06512	Cromado	Ø 30x11 cm
06515	Transparente	Ø 33x12,5 cm
06516	Negro	Ø 33x12,5 cm
06517	Cromado	Ø 33x12,5 cm



Buffet set Caterer
Bandeja acero inoxidable 18/10

Referencia	Medidas (cm)
------------	--------------

11195	53x32x10,5
-------	------------



Base tarta
Melamina

Referencia	Medidas (cm)
------------	--------------

00468	Ø 31x4 <input type="checkbox"/>
00469	Ø 31x4 <input checked="" type="checkbox"/>

Buffet set Hochtapler
Bandeja acero inoxidable 18/10

Referencia	Medidas (cm)
------------	--------------

11302	53x32x10,5
-------	------------



Pedestal tarta

Melamina Medida: Ø 31 cm

Referencia	Medidas (Altura)
------------	------------------

83890	8 cm
83891	16 cm



Tapas GN
SAN

Referencia	Pomo	Medidas
------------	------	---------

GN 1/1 11026	Cerrada	53x33x20 cm
GN 1/1 11027	Apertura frontal	53x33x20 cm
GN 1/1 11028	Apertura lateral	53x33x20 cm
GN 1/2 11021	Cerrada	33x18x17 cm
GN 1/2 11022	Apertura frontal	33x18x17 cm



Pedestal tarta

Acero inoxidable 18/10 Medida: Ø 34,5 cm

Referencia	Medidas (Altura)
------------	------------------

00466	13,5 cm
-------	---------



Tapa Roll Top
SAN

Referencia	Pomo	Medidas
18387	Dorado	Ø 38x20 cm
18388	Cromado	Ø 38x20 cm
18380	Dorado	Ø 50x26 cm
18383	Cromado	Ø 50x26 cm

Set Buffet Bret
Base madera haya tratada
Pies antideslizantes

Referencia	Medidas (cm)
00866	Ø 50

Set Rolltop
Base politileno
Pies antideslizantes

Referencia	Medidas (cm)
09081	Ø 38x24

Set Rolltop
Base acero inoxidable 18/10
Pies antideslizantes

Referencia	Medidas (cm)
09080	Ø 38x24
09099	Ø 50x28



Tapa Roll Top
Policarbonato Temperatura -30°C +120°C

Referencia	Pomo	Medidas
------------	------	---------

GN 1/1	11008	Dorado	53x32x19 cm
GN 1/1	11010	Cromado	53x32x19 cm
GN 1/1	12008	Dorado	53x32x26,5 cm
GN 1/1	12010	Cromado	53x32x26,5 cm

Base madera Bret
Base madera haya tratada
Pies antideslizantes

Referencia	Medidas (cm)
00865	58x38x2,5

Base buffet Top Fresh
Base acero inoxidable 18/10
Pies antideslizantes
2 acumuladores de frío

Referencia	Medidas (cm)
11510	61x38x8

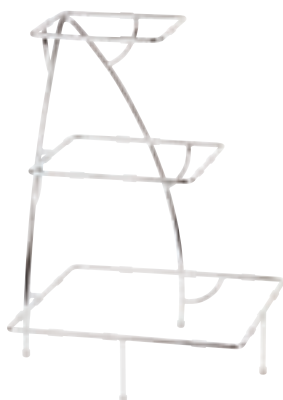

Expositor
Metálico

Referencia	Medidas (cm)
33231	37,5x37,5x50

Bandejas
Melamina

Referencia	Medidas (cm)
83407	21x21
83406	26,5x26,5
83405	37x37



Expositor extensible
Metálico
Para 4 platos max 31 cm

Referencia	Medidas (cm)
33225	Ø 34x37



Buffet Ladder
Metálico

Referencia	GN	Medidas
LITTLE 11526	1/3	31,5x32x48 cm
LITTLE 11527	1/2	31,5x41,5x48 cm
BIG 11528	1/1	31,5x56x66 cm

Gastronorm Super Shapes



- Formas exclusivas que destacan la presentación de las comidas.
- Elegante presentación de las comidas con una mínima inversión.
- Capacidad para reducir los desperdicios de comida.
- Cubetes apilables entre si.
- Acero inoxidable serie 300, espesor 0,8 mm.

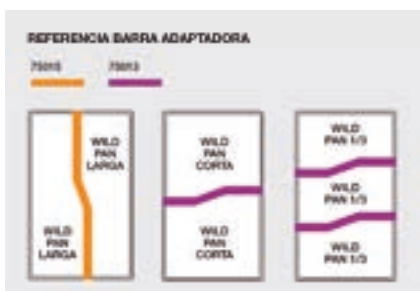

Super Pan® Super Shapes Ovalada

NSF	Referencia	Medidas	Capacidad
	GN 1/1 3101015	53x32,5x5,1 cm	3,7 L
	GN 1/1 3101020	53x32,5x6,5 cm	4,6 L
	GN 1/1 3101040	53x32,5x10 cm	7,8 L



Super Pan® Super Shapes Hexágono

NSF	Referencia	Medidas	Capacidad
	GN 1/1 3101220	53x32,5x6,5 cm	5 L
	GN 1/1 3101240	53x32,5x10 cm	8,8 L

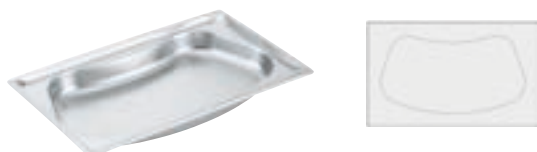

Super Pan® Super Shapes Reniforme

NSF	Referencia	Medidas	Capacidad
	GN 1/1 3101120	53x32,5x8,5 cm	4,8 L



Super Pan® Super Shapes Wild Pan larga

NSF	Referencia	Medidas	Capacidad
	GN 2/4 3100020	53x16,5x8,5 cm	3,5 L
	GN 2/4 3100040	53x16,5x8,9 cm	4,8 L



Super Pan® Super Shapes Óvalo

NSF	Referencia	Medidas	Capacidad
	GN 1/2 3102015	26,5x32,5x5,1 cm	1,6 L
	GN 1/2 3102020	26,5x32,5x6,5 cm	2,1 L
	GN 1/2 3102040	26,5x32,5x10 cm	3,5 L

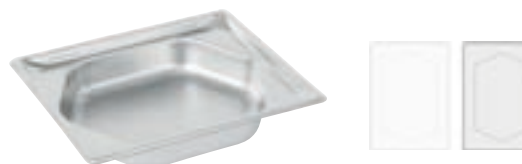

Super Pan® Super Shapes Hexágono

NSF	Referencia	Medidas	Capacidad
	GN 1/2 3102220	26,5x32,5x6,5 cm	2,1 L
	GN 1/2 3102240	26,5x32,5x10 cm	3,6 L



Super Pan® Super Shapes Reniforme

NSF	Referencia	Medidas	Capacidad
	GN 1/2 3102120	26,5x32,5x6,5 cm	2,1 L



Barra adaptadora

NSF	Referencia
75015	Barra adaptadora para fuentes Wild Pan, 3100020 y 3100040
75013	Barra adaptadora para fuentes Wild Pan - Fuentes cortas y Wild Pan, 3100220, 3100240, 3100320, 3100321, 3100340 y 3100341



Super Pan® Super Shapes Wild Pan corta

NSF	Referencia	Medidas	Capacidad
	GN 1/2 3100220	26,5x32,5x6,5 cm	3,9 L
	GN 1/2 3100240	26,5x32,5x10 cm	6,1 L



Super Pan® Super Shapes Óvalo

NSF	Referencia	Medidas	Capacidad
	GN 1/3 3103040	17,6x32,5x10 cm	2,1 L



Super Pan® Super Shapes Wild Pan externa

NSF	Referencia	Medidas	Capacidad
	GN 1/3 3100320	17,6x32,5x8,5 cm	2,5 L
	GN 1/3 3100340	17,6x32,5x10 cm	3,6 L



Super Pan® Super Shapes Wild Pan interna

NSF	Referencia	Medidas	Capacidad
	GN 1/3 3100321	17,6x32,5x8,5 cm	2,5 L
	GN 1/3 3100341	17,6x32,5x10 cm	3,6 L

Bols doble pared

Construcción aislante de doble pared, conserva la temperatura de los alimentos.

Referencia	Medidas
46587 + color	Ø 11,4x7,6 cm
46590 + color	Ø 18,4x10,3 cm
46591 + color	Ø 24x13 cm
46592 + color	Ø 30x16,5 cm
46569 + color	Ø 35x17,5 cm
47619 + color	14x14x7 cm
47632 + color	18x18x8,7 cm
47634 + color	21,6x21,6x13 cm
47635 + color	25,8x25,8x13 cm
47637 + color	30x30x15 cm



Miramar Buffet

Batería de cocina acero inoxidable

Miramar® para presentación.

- La batería pasa directamente de la cocina a su buffet en el mismo recipiente.
- Variedad de utensilios de cocina para todo tipo de comidas.





Fuentes decorativas y plantillas Miramar®

- Plantillas disponibles en acero inoxidable y color negro.
- Diversidad de formas con bordes decorados.



Plantilla agujeros redondo grande y pequeño



Referencia	Medidas	Color
------------	---------	-------

GN 1/1 8242014	536x324	Acero inoxidable 
GN 1/1 8242010	536x324	Negro 



Plantilla agujero oval grande

Referencia	Medidas	Color
------------	---------	-------

GN 1/1 8242314	536x324	Acero inoxidable 
GN 1/1 8242310	536x324	Negro 



Plantilla agujeros redondo grande y pequeño

Referencia	Medidas	Color
------------	---------	-------

GN 1/1 8242414	536x324	Acero inoxidable 
----------------	---------	--



Plantilla agujeros redondos grandes



Referencia	Medidas	Color
------------	---------	-------

GN 1/1 8242514	536x324	Acero inoxidable 
----------------	---------	--



Plantilla agujero redondo grande



Referencia	Medidas	Color
------------	---------	-------

GN 1/1 8242614	536x324	Acero inoxidable 
GN 1/1 8242610	536x324	Negro 



Plantilla agujero oval grande



Referencia	Medidas	Color
------------	---------	-------

GN 1/1 8242714	536x324	Acero inoxidable 
GN 1/1 8242710	536x324	Negro 



Plantilla para fuente

Referencia	Medidas	Color
------------	---------	-------

GN 1/1 8242814	536x324	Acero inoxidable 
GN 1/1 8242810	536x324	Negro 



Plantilla para fuente

Referencia	Medidas	Color
------------	---------	-------

GN 1/1 8242914	536x324	Acero inoxidable
----------------	---------	------------------



Plantilla para fuente

Referencia	Medidas	Color
------------	---------	-------

GN 1/1 8243014	536x324	Acero inoxidable
----------------	---------	------------------



Plantilla agujeros ovales grande y pequeño

Referencia	Medidas	Color
------------	---------	-------

GN 1/1 8243114	536x324	Acero inoxidable
----------------	---------	------------------



Plantilla agujeros redondos medianos

Referencia	Medidas	Color
------------	---------	-------

GN 1/1 8243214	536x324	Acero inoxidable
GN 1/1 8243210	536x324	Negro



Plantilla agujeros redondos grande y mediano

Referencia	Medidas	Color
------------	---------	-------

GN 1/1 8243314	536x324	Acero inoxidable
----------------	---------	------------------



Referencia	Medidas	Capacidad
------------	---------	-----------

43910	20x20x95 cm	2,9 L
43911	24x24x11 cm	4,8 L



Referencia	Medidas	Capacidad
------------	---------	-----------

49420	25,5x19x5 cm	1,7 L
49412	30,5x22x5 cm	2,5 L



Referencia	Medidas	Capacidad
------------	---------	-----------

49416	20x20x5 cm	1,2 L
49413	26x26x5 cm	4,8 L



Referencia	Medidas	Capacidad
------------	---------	-----------

49417	20x20x6 cm	1,7 L
49424	26x26x6 cm	2,9 L



Referencia	Medidas	Capacidad
------------	---------	-----------

49418	30x30x9,5 cm	4,9 L
49428	32x32x9 cm	6 L



Referencia	Medidas	Capacidad
------------	---------	-----------

49425	30x30x9 cm	6 L
-------	------------	-----



Referencia	Medidas	Capacidad
------------	---------	-----------

49430	14x14x7 cm	0,9 L
49414	16x16x9,5 cm	1,9 L



Referencia	Medidas	Capacidad
------------	---------	-----------

49435	29x24x5 cm	2,6 L
49433	37x30x5 cm	4,4 L



Referencia	Medidas	Capacidad
------------	---------	-----------

49431	36x28x10 cm	6,6 L
-------	-------------	-------

Porcelana Buffet

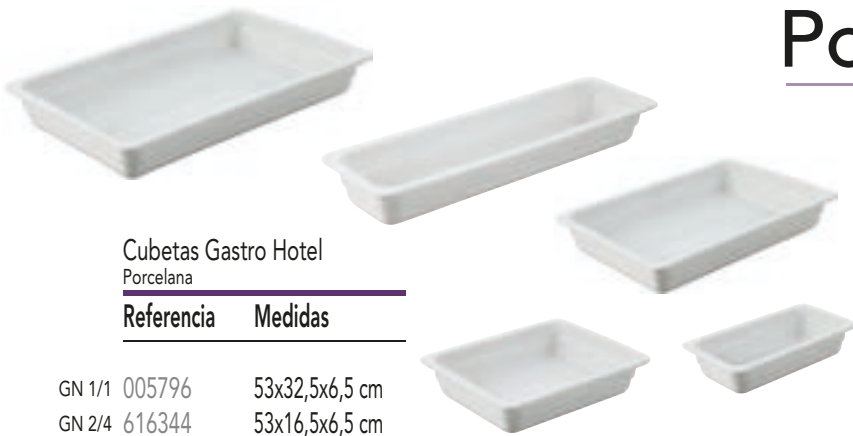

Cubetas Gastro Hotel
Porcelana

Referencia Medidas

GN 1/1	005796	53x32,5x6,5 cm
GN 2/4	616344	53x16,5x6,5 cm
GN 2/3	005465	35,2x32,5x6,5 cm
GN 1/2	005800	32,5x26,5x6,5 cm
GN 1/3	638794	32,5x17,6x6,5 cm

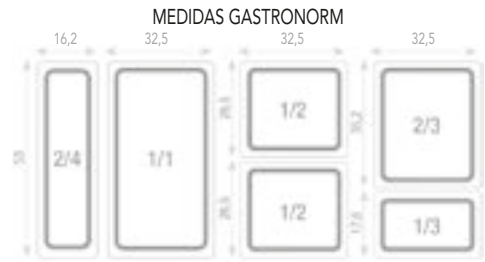

Revolution 2 Colección

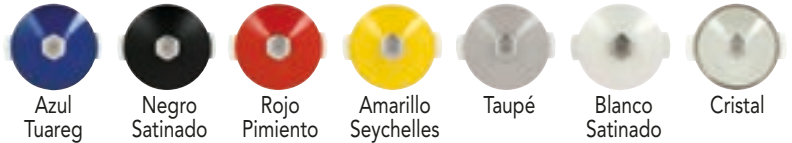
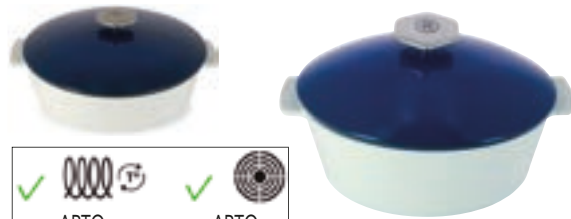

Cocotte oval

Referencia	Medidas	Capacidad
649993	23x19,5x14 cm	2 L
649994	23x19,5x14 cm	2 L
649991	23x19,5x14 cm	2 L
649989	23x19,5x14 cm	2 L
649990	23x19,5x14 cm	2 L
649922	23x19,5x14 cm	2 L
649870	32,5x26,5x16 cm	3,5 L
649871	32,5x26,5x16 cm	3,5 L
649869	32,5x26,5x16 cm	3,5 L
649867	32,5x26,5x16 cm	3,5 L
649868	32,5x26,5x16 cm	3,5 L
649872	32,5x26,5x16 cm	3,5 L
649873	32,5x26,5x16 cm	3,5 L

Cocotte Redonda

Referencia	Medidas	Capacidad
649817	Ø 23 cm	2,4 L
649816	Ø 23 cm	2,4 L
649815	Ø 23 cm	2,4 L
649813	Ø 23 cm	2,4 L
649814	Ø 23 cm	2,4 L
649818	Ø 23 cm	2,4 L
649820	Ø 23 cm	2,4 L
649854	Ø 26 cm	3,4 L
649855	Ø 26 cm	3,4 L
649853	Ø 26 cm	3,4 L
649851	Ø 26 cm	3,4 L
649852	Ø 26 cm	3,4 L
648856	Ø 26 cm	3,4 L
648857	Ø 26 cm	3,4 L

Cocotte baja

Referencia	Medidas	Capacidad
649862	Ø 28x13,5 cm	3,6 L
649863	Ø 28x13,5 cm	3,6 L
649861	Ø 28x13,5 cm	3,6 L
649589	Ø 28x13,5 cm	3,6 L
649860	Ø 28x13,5 cm	3,6 L
649864	Ø 28x13,5 cm	3,6 L
649865	Ø 28x13,5 cm	3,6 L

Tajin

Referencia	Medidas	Capacidad
649877	Ø 32x21,5 cm	3 L
649876	Ø 32x21,5 cm	3 L

Porta tapas acero inoxidable

Referencia	Medidas
644282	30,5x23x37,5 cm Alto
645051	30,5x23x37,5 cm Bajo

Fuentes gastronorm GN



Melamina

Fuente GN 1/1
Medida: 53x32 cm

Referencia	Fondo
------------	-------

B885000	6,5 cm <input type="checkbox"/>
B885160	6,5 cm <input checked="" type="checkbox"/>
B885208	10 cm <input type="checkbox"/>
B885213	10 cm <input checked="" type="checkbox"/>

Fuente GN 2/4
Medida: 53x16,2 cm

Referencia	Fondo
------------	-------

B885002	6,5 cm <input type="checkbox"/>
---------	---------------------------------

Fuente GN 1/3
Medida: 32,5x17,6 cm

Referencia	Fondo
------------	-------

B885003	6,5 cm <input type="checkbox"/>
B885210	10 cm <input type="checkbox"/>
B885215	10 cm <input checked="" type="checkbox"/>

Fuente GN 1/4
Medida: 26,5x16,2 cm

Referencia	Fondo
------------	-------

B885005	6,5 cm <input type="checkbox"/>
B885211	10 cm <input type="checkbox"/>
B885216	10 cm <input checked="" type="checkbox"/>

Fuente GN 1/2
Medida: 32,5x26,5 cm

Referencia	Fondo
------------	-------

B885001	6,5 cm <input type="checkbox"/>
B885161	6,5 cm <input checked="" type="checkbox"/>
B885209	10 cm <input type="checkbox"/>
B885214	10 cm <input checked="" type="checkbox"/>

Fuente GN 2/3
Medida: 35x32 cm

Referencia	Fondo
------------	-------

B885004	6,5 cm <input type="checkbox"/>
---------	---------------------------------

Fuente GN 1/6
Medida: 17,6x16 cm

Referencia	Fondo
------------	-------

B885006	6,5 cm <input type="checkbox"/>
B885212	6,5 cm <input type="checkbox"/>
B885217	10 cm <input checked="" type="checkbox"/>



Bayahive

Referencia	GN
------------	----

B885260R	1/1
B885261R	1/2
B885264R	2/4
B885262R	1/3
B885263R	1/4



Bayahive Wood

Referencia	GN
------------	----

B885265R	1/1
B885266R	1/2
B885269R	2/4
B885267R	1/3
B885268R	1/4



Bayahive Wood

Referencia	GN
------------	----

B885280	1/1
B885281	1/2
B885284	2/4
B885282	1/3
B885283	1/4
B885285	1/6



Bayahive Wood

Referencia	GN
------------	----

B885286	1/1
B885287	1/2
B885290	2/4
B885288	1/3
B885289	1/4
B885291	1/6



Referencia	Medidas	Capacidad
------------	---------	-----------

GN 1/2	84000	32,5x26,5x8,5 cm	3,5 L <input type="checkbox"/>
GN 2/4	84002	53,5x16,2x8,5 cm	3,2 L <input type="checkbox"/>
GN 1/4	84004	26,5x16,2x8,5 cm	1,4 L <input type="checkbox"/>
	84006	25x25x8,5 cm	2,8 L <input type="checkbox"/>
GN 1/2	84001	32,5x26,5x8,5 cm	3,5 L <input checked="" type="checkbox"/>
GN 2/4	84003	53,5x16,2x8,5 cm	3,2 L <input checked="" type="checkbox"/>
GN 1/4	84005	26,5x16,2x8,5 cm	1,4 L <input checked="" type="checkbox"/>
	84007	25x25x8,5 cm	2,8 L <input checked="" type="checkbox"/>



Stone Art

Referencia	Medidas	GN
84519	53x32,5x1,5 cm	1/1
84520	32,5x26,5x1,5 cm	1/2
84521	32,5x17,6x1,5 cm	1/3
84522	53x16,2x1,5 cm	2/4

La Vida

Referencia	Medidas	GN
84144	53x32,5x1,5 cm	1/1
84145	32,5x26,5x1,5 cm	1/2
84146	53x16,2x1,5 cm	2/4
84147	53x32,5x1,5 cm	1/1
84148	32,5x26,5x1,5 cm	1/2
84149	53x16,2x1,5 cm	2/4

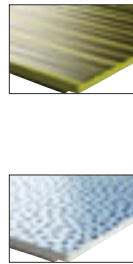
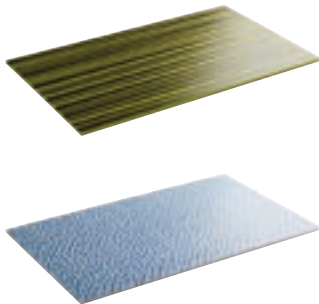

Bandeja rectangular

Referencia	Referencia	Medidas	GN
15439	15444	53x32,5x1,5 cm	1/1
15440	15445	32,5x26,5x1,5 cm	1/2
15441	15446	32,5x17,6x1,5 cm	1/3
15442	15447	26,5x16,2x1,5 cm	1/4
15443	15448	53x16,2x1,5 cm	2/4



Bandeja rectangular

Referencia	Referencia	Medidas	GN
15449	15455	53x32,5x3 cm	1/1
15450	15456	32,5x26,5x3 cm	1/2
15451	15457	32,5x17,6x3 cm	1/3
15452	15458	26,5x16,2x3 cm	1/4
15453	15459	35,4x32,5x3 cm	2/3
15454	15460	53x16,2x3 cm	2/4

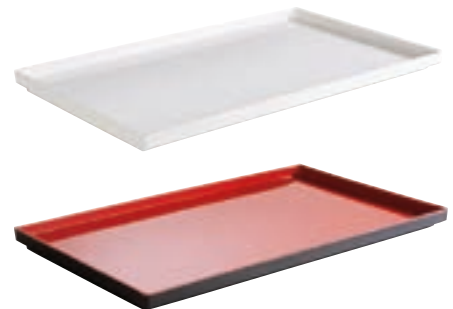

Referencia	Referencia	Referencia	Referencia	Medidas	GN
NEGRA	BLANCA	PIZARRA	MÁRMOL		
84195	84185	83955	84360	53x32,5x1,5 cm	1/1
84196	84186	83956	84361	32,5x26,5x1,5 cm	1/2
84197	84187	83957	84362	32,5x17,6x1,5 cm	1/3
84198	84188	83958	84363	26,5x16,2x1,5 cm	1/4
84199	84189	83971	84364	53x32,5x1,5 cm	2/4



Espejos GN

Referencia	Medidas	GN
00961	53x32x3 cm	1/1
00962	32,5x26,5x3 cm	1/2
00963	32,5x17,6x3 cm	1/3
00964	53x16,2x3 cm	2/4



Superbox



Caja madera

Referencia	Referencia	Medidas	GN
11620	11626	55,5x35x10,5 cm	1/1
11623	11629	55,5x18,5x10,5 cm	2/4
11621	11627	35x29x10,5 cm	1/2
11622	11628	29x18,5x10,5 cm	1/4

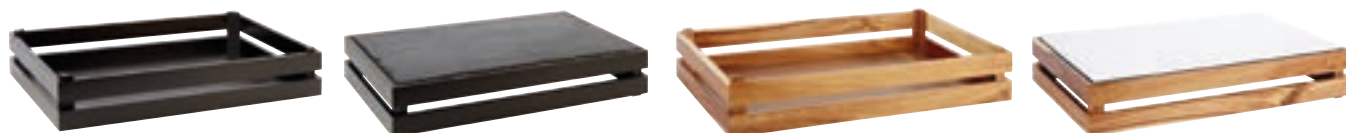

Cajas Madera haya GN



Alzadores

Referencia	Medidas (Altura)	GN
3030	10 cm	1/1
3031	18 cm	1/1

Cajas

Referencia	Medidas	GN
3000	53x32,5x10 cm	1/1
3001	32,5x26,5x10 cm	1/2
3002	32,5x17,6x10 cm	1/3
3003	26,5x16,2x10 cm	1/4
3004	53x16,2x10 cm	2/4

Campana metacrilato

Referencia	GN
3030	1/1



Melamina



La Vida

Referencia	Medidas
84161	Ø 32 cm
84170	Ø 40,5 cm
84165	Ø 32 cm
84168	Ø 40,5 cm
84174	Ø 32 cm
84172	Ø 40,5 cm



Frida

Referencia	Referencia	Referencia	Medidas	Capacidad	GN
84555	84556	84557	17,6x10,8x5,5 cm	0,5 L	1/9
84558	84559	84560	16,5x16,5x5,5 cm	0,85 L	
84561	84562	84563	25x25x5,5 cm	2,65 L	1/9
84564	84565	84566	53x16,2x7,5 cm	3,65 L	1/9



Perpignan

Referencia	Referencia	Referencia	Medidas
B885228	B885218	B885223	30x21x12 cm
B885229	B885219	B885224	21,5x17,5x10 cm
B885230R	B885220R	B885225R	17x14x8 cm
B885231R	B885221R	B885226R	15x12x7 cm
B885231R	B885222R	B885227R	12x10x6 cm

Soho

Referencia	Referencia	Referencia	Medidas
B885292	B885307	B885295	Ø 22x22
B885293	B885308	B885296	Ø 18x18
B885294	B885309	B885297	Ø 14x14



Pure

Referencia	Medidas	Capacidad
84490	Ø 5,5x4 cm	0,02 L
84491	Ø 9,5x4,5 cm	0,09 L
84492	Ø 12x6,5 cm	0,3 L
84493	Ø 15x7,5 cm	0,45 L
84494	Ø 20x10,5 cm	1,25 L

Bols Float
Melamina
Apilables



Referencia	Referencia	Medidas	Capacidad
●	○		
83901	83900	Ø 5,5 cm	0,03 L
83903	83902	Ø 9 cm	0,15 L
83905	83904	Ø 13 cm	0,45 L
83907	83906	Ø 15 cm	0,7 L
83909	83908	Ø 20,5 cm	1,9 L

Referencia	Referencia	Medidas	Capacidad
●	○		
83910	83910	5,5x5,5 cm	0,03 L
83913	83912	9x9 cm	0,16 L
83915	83914	12,5x12,5 cm	6 L
83917	83916	19x19 cm	9,5 L
83919	83918	25x25 cm	12 L

Tapas Float

Referencia	Medidas
83920	Ø 20,5 cm
83921	19x19 cm
83922	25x25 cm



Pure Color
Melamina

Referencia	Referencia	Referencia	Referencia	Medidas
○	●	●	●	
83414	83466	83568	83569	9x9 cm
83410	83467	83570	83571	12,5x12,5 cm
83409	83468	83572	83573	19x19 cm
83408	83469	83574	83575	25x25 cm



Pure Bicolor
Melamina

Referencia	Referencia	Referencia	Medidas
●○	○●	●○	
84414	84415	84420	9x9 cm
84410	84416	84421	12,5x12,5 cm
84409	84417	84422	19x19 cm
84408	84418	84423	25x25 cm



Tapas SAN

Referencia	Medidas
83600	19x19 cm
83601	25x25 cm

Balance
Melamina

Referencia	Referencia	Medidas	Capacidad
○	●		
84040	85040	Ø 14,5 cm	0,4 L
84041	85041	Ø 21 cm	1,5 L
84042	85042	Ø 24,5 cm	2,5 L
84043	85043	Ø 30 cm	5 L



Ming
Melamina

Referencia	Referencia	Referencia	Medidas
○	●	●	
B885066			30x30x13,5 cm
B885067		B885177	25x25x11,4 cm
B885068		B885178	21x21x9,5 cm
B885069	B885251	B885179	15x15x13,5 cm
B885070R	B885252R	B885180R	10x10x6 cm
B885071R	B885253R	B885181R	8x8x4,5 cm



Trattoria
Melamina

Referencia	Referencia	Referencia	Medidas
○	●	●	
B885054		B885361	Ø 26x7,1x13,7 cm
B885055		B885362	Ø 23x6,6x12,5 cm
B885056		B885363	Ø 21x5,4x10,5 cm
B885101	B885254R		Ø 9x4,4 cm





Natural
Melamina

Referencia	Referencia	Referencia	Medidas
○	●	●	
84083	84084	84085	40x18,5 cm
84086	84087	84088	52x25 cm



Referencia	Referencia	Referencia	Medidas
○	●	●	
83871	83872	83865	27x27 cm
83444	83445	83446	34x34 cm
83873	83874	83866	42x42 cm



Referencia	Referencia	Referencia	Medidas
○	●	●	
84080	84081	84082	40x18,5x10 cm



Referencia	Referencia	Referencia	Medidas
○	●	●	
83435	83436	83437	36x16 cm
83438	83439	83440	45x24 cm
83441	83442	83443	53x29 cm



Timber
Melamina

Referencia	Medidas
84266	Ø 35 cm
84267	Ø 40 cm
84268	44x25 cm
84269	65x26 cm
84256	70x26 cm



Referencia	Referencia	Referencia	Medidas
○	●	●	
83864	83863	83862	35,5x8 cm



OAK
Melamina

Referencia	Medidas
84177	Ø 35 cm
84178	40x20 cm
84179	48x20 cm



Slate
Melamina

Referencia	Medidas
84240	Ø 18,5 cm
84241	Ø 23 cm
84242	Ø 33,5 cm
84243	Ø 37 cm



Tapas
SAN

Referencia	Medidas
15350	Ø 16,5 cm
15351	Ø 20,5 cm
06512	Ø 30 cm
06517	Ø 33 cm



Fusión
Melamina



Referencia	Medidas	Capacidad
84022	Ø 11x7 cm	0,3 L
84023	Ø 17x8,5 cm	1 L
84024	Ø 20x8 cm	1,2 L



Referencia	Medidas
84025	23,5x7,5 cm
84026	24,5x6,5 cm



Marone Melamina		
Referencia	Medidas	Capacidad
84110	Ø 14x6 cm	0,3 L
84111	Ø 19x8 cm	0,8 L
84112	Ø 21x8,5 cm	1 L
84113	Ø 24x9,5 cm	1,4 L
84174	Ø 30,5x6 cm	2 L



Referencia	Medidas
84103	14,5x14,5 cm



Referencia	Medidas
84104	22,5x15 cm
84105	27,5x11 cm



Referencia	Medidas
84106	26,5x16,5 cm



Referencia	Medidas
84117	19,5x9,5 cm
84118	39x16 cm



Referencia	Medidas
84119	32,5x23,5 cm



Referencia	Medidas	Capacidad
84100	25,5x14x5,5 cm	0,4 L
84101	36x19x8 cm	0,9 L



Referencia	Medidas	Capacidad
84114	23,5x23,5 cm	0,7 L



Referencia	Medidas	Capacidad
84115	Ø 11x3,5 cm	0,13 L
84116	Ø 14x4 cm	0,2 L



Referencia	Medidas	Capacidad
84109	Ø 11x5,5 cm	0,2 L



Referencia	Medidas	Capacidad
84107	Ø 8,5x2,5 cm	0,05 L
84108	Ø 11,5x3 cm	0,04 L

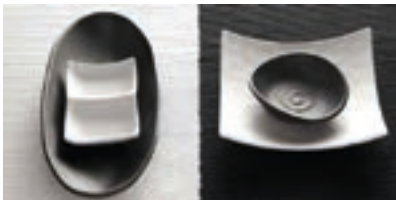

Zen Melamina			
Referencia	Referencia	Medidas	Capacidad
○ 83928	● 83929	Ø 31x8,5 cm	



Referencia	Referencia	Medidas	Capacidad
○ 83710	● 83712	21x21 cm	1,4 L



Referencia	Referencia	Medidas	Capacidad
○ 84354	● 84355	Ø 22,5x12,5 cm	0,8 L



Referencia	Referencia	Medidas	Capacidad
○ 84348	● 84349	Ø 10x7 cm	0,08 L
84350	84351	Ø 12,5x8,5 cm	0,15 L
84352	84353	Ø 16x7 cm	0,3 L



Referencia	Referencia	Medidas
○ 83938	● 83939	32,5x14x4 cm



Referencia	Referencia	Medidas
○ 83742	● 83744	22,5x9,5x3 cm



Referencia	Referencia	Medidas	Capacidad
○ 84340	● 84341	7x7x2 cm	0,03 L
84342	84343	9x9x2,5 cm	0,06 L
84344	84345	13,5x13,5x4 cm	0,2 L
84346	84347	16,5x16,5x4,5 cm	0,3 L



Referencia	Referencia	Medidas
○ 83946	● 83947	9x7x2,5 cm



Referencia	Referencia	Medidas	Capacidad
○ 83729	● 83731	18x10x3,5 cm	0,1 L
83733	83735	25x13,5x4 cm	0,25 L
83737	83739	30,5x17,5x5 cm	0,6 L



Teka
Melamina

Referencia	Color	Medidas
B98235053	Teka	53x27x2 cm
B98235033	Teka	33x30x2 cm
B98235040N	Nogal	50x19,5x2 cm
B98235040T	Teka	50x19,5x2 cm



Vinea
Melamina

Referencia	Referencia	Referencia	Medidas
B98234034M	B98234034C	B98234034P	34x25x3 cm
B98234029M	B98234029C	B98234029P	29x20x2,5 cm
B98234025M	B98234025C	B98234025P	25x18x2,3 cm
B98234020M	B98234020C	B98234020P	20x13x2 cm



Terra
Melamina

Referencia	Referencia	Referencia	Medidas
B98230034M	B98230034C	B98230034T	34x23x3,5 cm
B98230027M	B98230027C	B98230027T	27,5x19x3 cm

Terra
Melamina

Referencia	Referencia	Referencia	Medidas
B98226028M	B98226028C	B98226028T	Ø 28x11 cm
B98226023M	B98226023C	B98226023T	Ø 23x9,5 cm



Terra Leaf
Melamina

Referencia	Referencia	Referencia	Medidas
B98231036M	B98231036C	B98231036T	35,5x15,5x4,5 cm



Terra Góndola
Melamina

Referencia	Referencia	Referencia	Medidas
B98232035M	B98232035C	B98232035T	35,5x16x6 cm
B98232028M	B98232028C	B98232028T	28,5x12,5x5 cm





Terra Elips
Melamina

Referencia	Referencia	Referencia	Medidas
●	●	●	
B98227023M	B98227023C	B98227023T	23x14,5x4 cm
B98227018M	B98227018C	B98227018T	18x11,5x3 cm

Terra Elips
Melamina

Referencia	Referencia	Referencia	Medidas
●	●	●	
B98225109M	B98225109C	B98225109T	9x8,5x4 cm
B98225217M	B98225217C	B98225217T	17,5x8,5x3 cm
B98225326M	B98225326C	B98225326T	17,5x8,5x3 cm



Ming
Melamina

Referencia	Referencia	Medidas
○	●	
B885057		46,2x46,2x5,4 cm
B885058	B885168	35,8x35,8x4,4 cm
B885059R	B885169R	25,5x25,5x2,8 cm
B885060R	B885170R	20,5x20,5x2,4 cm
B885061R	B885171R	15,2x15,2x1,7 cm
B885062	B885172	60x32x5 cm
B885063		46x27x5 cm
B885064		35,5x20,2x3,6 cm
B885065	B885175	30,5x19x3 cm



Degustación Troya
Melamina

Referencia	Referencia	Referencia	Medidas
○	●	●	
B885332R3	B885336R3	B885334R3	Ø 13x2,5 cm
B885333R6	B885337R6	B885335R6	Ø 10x2 cm
B885338R3	B885342R3	B885340R3	11x11x3,5 cm
B885339R6	B885343R6	B885341R6	9x9x3 cm

Ramequín
Melamina

Referencia	Referencia	Referencia	Medidas
○	●	●	
B885045R	B885244R	B885247R	Ø 8,3x4,4 cm
B885046R	B885245R	B885248R	Ø 7,7x4,1 cm
B885047R	B885246R	B885249R	Ø 6,2x3,6 cm



Oval Pétalo
Melamina

Referencia	Referencia	Referencia	Medidas
○	●	●	
B885323R3	B885327R3	B885325R3	16,5x12,5x3 cm
B885324R6	B885328R6	B885326R6	12x9x2 cm



Góndola
Melamina

Referencia	Referencia	Medidas
○	●	
B98213074B	B98213074N	10,5x6,3x3,3 cm



Boat
Melamina

Referencia	Referencia	Referencia	Referencia	Referencia	Medidas
					14,5x4,5 cm
84128	84140	84141	84142	84143	



Hong Kong
Melamina

Referencia	Referencia	Referencia	Referencia	Medidas
				14,5x4,5 cm
83486	83487	83424	83426	



Bowl degustación
Melamina

Referencia	Referencia	Medidas
		9x5,5 cm
B98213115B	B98213115N	



Ming Hing
Melamina

Referencia	Referencia	Medidas
		11x4,5 cm
83842	83843	



Bowl salsas
Melamina

Referencia	Referencia	Medidas
		Ø 8x3,5 cm
B9821308B	B9821308N	Ø 6x2,5 cm
B9281306B	B9281306N	



Leaf
Melamina

Referencia	Referencia	Referencia	Medidas
			10x4,5 cm
83887	83888	83889	



Cocotte
Melamina

Referencia	Referencia	Referencia	Medidas
			Oval 17x10x5 cm
B885364R1	B885366R1	B885365R1	Ø 7x9x4 cm
B885367R1	B885369R1	B885368R1	



Cocotte
Melamina

Referencia	Referencia	Referencia	Referencia	Referencia	Referencia	Referencia	Medidas	Capacidad
							Ø 10x6,5 cm	0,25 L
P23.800	P23.801	P23.802	P23.803	P23.804	P23.805	P23.806	Ø 14x8 cm	0,75 L
P23.810	P23.811	P23.812	P23.813	P23.814	P23.815	P23.816		



Profi Line
Acero inoxidable 18/10
GN 1/1

Referencia	Medidas
11000	53x32 cm



Redonda

Referencia	Medidas
11032	Ø 32 cm
11038	Ø 38 cm
11048	Ø 48 cm



Oval

Referencia	Medidas
11023	50x36 cm
11024	60x41 cm
11025	70x46 cm



GN 1/1 Apilable

Referencia	Medidas
11300	53x32 cm



Pizarra Natural GN 1/1 Apilable

Referencia	Medidas
00966	53x32 cm

Essen
Acero inoxidable 18/10
Rectangular

Referencia	Medidas
------------	---------



00383	35x24 cm
00382	42x31 cm
00381	50x36 cm
00384	63,5x44,5 cm
00385	60x40 cm
00388	53x32 cm
03824	42x31 cm
03814	50x36 cm
00087	38x23 cm
00086	47x31 cm

Oval

Referencia	Medidas
00089	53x39,5 cm



Asa

Referencia	Medidas
00082	52x31 cm
00081	60x36 cm
00084	75x44 cm

Redonda

Referencia	Medidas
00075	Ø 31 cm
00085	Ø 35 cm



Con tapa

Referencia	Medidas
38202	42x31 cm

Classic
Acero inoxidable 18/10
GN 1/1 Apilable

Referencia	Medidas
11295	53x32 cm

GN 1/1 Apilable 45 agujeros Ø 3,5 cm

Referencia	Medidas
11168	53x32 cm

Swing
Acero inoxidable 18/10
GN 1/1 Apilable

Referencia	Medidas
01425	53x32 cm

Referencia	Medidas
------------	---------

01415	28,5x20 cm
01420	53x32,5 cm

Referencia	Medidas
------------	---------

01416	32,5x32,5 cm
-------	--------------

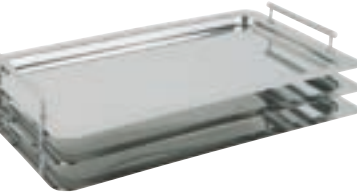

Elevadas
Acero inoxidable 18/10

Referencia	Medidas
11470	Ø 48 cm
11475	53x32 cm

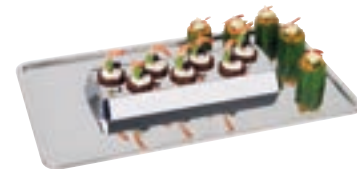

Halbmond
Acero inoxidable 18/10
GN 1/1

Referencia	Medidas
11111	53x32 cm



Classic
Acero inoxidable 18/10

Referencia	Medidas
------------	---------

GN 1/1 00395	53x32 cm
00399	41x31 cm

GN 2/3 00389	35,4x32,5 cm
00396	Ø 35 cm
00398	46x34 cm





Frutero Royal

Referencia	Medidas
------------	---------

24336 Ø 24/33/42x43,5 cm



Buffet Ladder
Bol vidrio Ø 23 cm

Referencia	Medidas
------------	---------

11599 39x31x66 cm



Buffet Stand

Referencia	Medidas
------------	---------

33235 Ø 27x32 cm
33240 Ø 32x53 cm

Fruteros



Frutero inox 18/10

Referencia	Medidas
------------	---------

30270 Ø 21x20,5 cm



Dispensador cubiertos
Acero inoxidable

Referencia	Medidas	Huecos
------------	---------	--------

11996 26x30x20 cm 4
11997 37,5x30x20 cm 6



Dispensador cubiertos
Melamina/SAN

Referencia	Medidas	Huecos
------------	---------	--------

93321 27x27x15 cm 4

Cesto cubiertos GN 1/1
Polipropileno

Referencia	Medidas
------------	---------

11966 53x32,5x9 cm



Cesto cubiertos
Polipropileno

Referencia	Medidas
------------	---------

40130 Ø 12x15 cm
40007 Ø 12x15 cm
40131 27x10x15x15 cm
40009 27x10x15x15 cm



Set mesa cubiertos
Melamina/metal

Referencia	Medidas
------------	---------

11927 22x22x26 cm

Cesto cubiertos
Polipropileno

Referencia	Medidas
------------	---------

40179 26x18x15 cm
40182 26x18x15 cm



Country Style
Madera

Referencia	Medidas
------------	---------

11931 Ø 11,5x14 cm



Estación pan
Melamina/madera

Referencia	Medidas
------------	---------

83615 Bandeja 59,5x35,5x3,5 cm
00953 Tabla 52x34x2 cm
00959 Caja 34x26x12,5 cm
00954 Caja 34x26x20 cm

Cubierta higiénica antialiento
Metal/acrílico

Referencia	Medidas
------------	---------

11556 82x42x45 cm



Tablas de pan

Tablas pan madera antideslizante



Referencia	Referencia	Medidas
------------	------------	---------

PINO ACACIA
00955 00883 47,5x32x2 cm
00956 00884 53x32x2 cm
00957 00885 60x40x2 cm

Paneras buffet

Dispensador pan
Cestas no incluidas. Ruedas traseras

Referencia Medidas

P906.100 35,5x50x160 cm 
P906.150 35,5x50x160 cm 

Cesta redonda inclinada

Referencia Referencia Medidas

 
P100.750 P100.752 Ø 36x10/20 cm
P100.751 P100.753 Ø 40x13/23 cm

Profi Line

Referencia Medidas

50210 Ø 37 cm
50215 Ø 42 cm

Referencia Medidas

50205 Ø 31/37 cm

Referencia Medidas

50100 Ø 36,5 cm
50105 Ø 42 cm
50110 Ø 46 cm



Polipropileno

Referencia Medidas

50510 60x40x60 cm

Polipropileno

Referencia Medidas

50500 Ø 28/30x38 cm 
50501 Ø 28/30x38 cm 

Polipropileno

Referencia Medidas

50900 40x20x5 cm
50905 40x30x5 cm
50910 60x20x5 cm
50915 60x40x5 cm

Metal

Referencia Medidas

33221 46x24x18/21 cm

Polipropileno

Trenzado a mano en fibra sintética, su acabado mate da aspecto de un producto natural.

Cestas baguette

Referencia Medidas

P100.780 Ø 35x35 cm
P100.781 Ø 36x36 cm





Polipropileno

Referencia Medidas



50300 30x40x27/16 cm
50305 45x40x27/16 cm
50310 60x40x27/16 cm



Referencia Referencia Referencia Medidas GN

  
40291 40220 40260 53x32x6 cm 1/1
40290 40222 40262 32,5x26,5x6 cm 1/2
40223 40224 40263 32,5x17,6x6 cm 1/3
40225 40226 40264 26,5x16,2x6 cm 1/4
40227 40228 40266 17,6x16,2x6 cm 1/6
40229 40230 40268 32,5x35,4x6 cm 2/3

Referencia Referencia Referencia Medidas GN

  
40293 40240 40270 53x32x10 cm 1/1
40292 40242 40272 32,5x26,5x10 cm 1/2
40243 40244 40274 32,5x17,6x10 cm 1/3
40245 40246 40276 26,5x16,2x10 cm 1/4
40247 40248 40278 17,6x16,2x10 cm 1/6
40249 40250 40280 32,5x35,4x10 cm 2/3

Referencia Medidas GN

11553 29x27x35 cm 1/2
11555 50x34x37,5 cm 1/1





Metacrilato

Referencia	Medidas
------------	---------

11566	26x10x11 cm
11563	22x17x9 cm



Polipropileno

Referencia	Medidas
------------	---------

40299	Ø 26x17 cm	
30299	Ø 26x17 cm	



Madera

Referencia	Medidas
------------	---------

11575	33,5x20x9 cm	
11574	33,5x20x9 cm	



Algodón

Referencia	Medidas
------------	---------

30380	Ø 20x23,5 cm	
30390	Ø 20x23,5 cm	

Huevera
Melamina

Referencia	Medidas
------------	---------

B885190R	Ø 5x6,5 cm
----------	------------



Madera

Referencia	Medidas
------------	---------

11775	31x28x9 cm	
11776	31x28x9 cm	



Madera

Referencia	Medidas
------------	---------

11635	17x17x10 cm	
11636	17x17x10 cm	
11637	17x17x10 cm	



Dispensador de Miel
y mermelada para buffet



Madera

Referencia	Medidas
------------	---------

11638	27x17x10 cm	
11639	27x17x10 cm	
11640	27x17x10 cm	



Portabolsitas azúcar
Melamina

Referencia	Referencia	Medidas
------------	------------	---------

		7x11x5,5 cm
B885188V	B885191V	

Utensilios buffet



Referencia	Pieza
------------	-------

07600080	Pala Lasaña 28 cm
----------	-------------------



Referencia	Pieza
------------	-------

07600082	Pala Huevos 28 cm
----------	-------------------



Referencia	Pieza
------------	-------

07600081	Pala Tarta con corte 30 cm
----------	----------------------------



Referencia	Pieza
------------	-------

07600069	Pala Servir con corte 28 cm
----------	-----------------------------



Referencia	Pieza
------------	-------

07600143	Tenedor 5 púas 26 cm
----------	----------------------



Referencia	Pieza
------------	-------

07600288	Tenedor 3 púas 30 cm
----------	----------------------



Referencia	Pieza
------------	-------

07600060	Cuchara de Arroz 26 cm
----------	------------------------



Referencia	Pieza
------------	-------

07600059	Cucharón Multiuso 30 cm
----------	-------------------------



Referencia	Pieza
------------	-------

07600259	Cuchara servir perforada 30 cm
----------	--------------------------------

Pinzas profesionales



Referencia	Pieza
------------	-------

50919601	Spaghetti 26 cm
----------	-----------------



Referencia	Pieza
------------	-------

50919901	Pinzas Gastronorm 26 cm
----------	-------------------------



Referencia	Pieza
------------	-------

50919701	Servir 26 cm
----------	--------------



Referencia	Pieza
------------	-------

50919501	Pan 26 cm
----------	-----------



Referencia	Pieza
------------	-------

50919001	Ensalada 26 cm
----------	----------------



Referencia	Pieza
------------	-------

50919400	Pinzas Dulce 20 cm
----------	--------------------



Referencia	Pieza
------------	-------

50919500	Pinzas Pan 22 cm
----------	------------------



Referencia	Pieza
------------	-------

605100	Pinza Charcutería 10 cm
--------	-------------------------



Referencia	Pieza
------------	-------

509180000	Pinzas repostería 20 cm
-----------	-------------------------



Inox 18/10

Referencia	Medida
------------	--------

00685	Largo 25 cm
-------	-------------



Inox 18/10

Referencia	Medida
------------	--------

00688	Largo 25 cm
-------	-------------



Inox 18/10

Referencia	Medida
------------	--------

00686	Largo 25 cm
-------	-------------



Inox 18/10

Referencia	Medida
------------	--------

00687	Largo 25 cm
-------	-------------



Referencia	Pieza
------------	-------

50919100	Pinza Azúcar 11 cm
----------	--------------------



Policarbonato (PP)

Referencia **Medidas**

B885270R	29 cm	<input type="checkbox"/>
B885272R	29 cm	<input checked="" type="checkbox"/>



Policarbonato (PP)

Referencia **Medidas**

B885271R	22,5 cm	<input type="checkbox"/>
B885273R	22,5 cm	<input checked="" type="checkbox"/>



Policarbonato (PP)

Referencia **Medidas**

B885274R	33 cm	<input type="checkbox"/>
B885275R	33 cm	<input checked="" type="checkbox"/>
B885276R	36 cm	<input type="checkbox"/>
B885277R	36 cm	<input checked="" type="checkbox"/>



Policarbonato (PP)

Referencia **Medidas**

B885278R	25 cm	<input type="checkbox"/>
B885279R	25 cm	<input checked="" type="checkbox"/>



Reposacucharas melamina

Referencia **Medidas**

83897	26x13x4,5 cm
-------	--------------



Reposacucharas melamina

Referencia **Medidas**

83801	16x10x5 cm
-------	------------



Reposacucharas inox

Referencia **Medidas**

00650	27x11x3,5 cm
-------	--------------



Melamina
Capacidad 1 L

Referencia

83867	<input type="checkbox"/>
83868	<input checked="" type="checkbox"/>



Set 10 clips FLEX LABEL
Policarbonato PC

Referencia **Referencia** **Medidas**

<input checked="" type="checkbox"/>	<input type="checkbox"/>	
71474	71472	9,5 cm
71475	71473	12,5 cm



Set 10 clips portaetiquetas
Polipropileno

Referencia **Referencia** **Medidas**

<input checked="" type="checkbox"/>	<input type="checkbox"/>	
71482	71483	6x2,7 cm



Soporte cartelito FLEXILABEL
Metal cromado. Incluye 10 cartelitos

Referencia **Medidas**

71480	12 cm
71481	23 cm

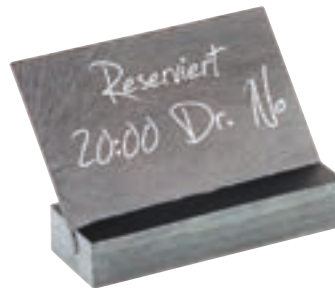

Pizarra

Referencia **Medidas**

00060	12x4x7 cm
-------	-----------



Set 4
Acrílico

Referencia **Medidas**

Cubo	00078	3x3x4 cm
Cilindro	00079	3x3x4 cm



Set 4

Referencia **Medidas**

Acrílico	00074	3x3x12 cm
Madera	00700	2,5x2,5x12 cm

Vajilla Catering Wave



Cuchara degustación



Cucharilla



Vaso degustación



Referencia	Referencia	Referencia	Descripción	Dimensiones (mm)	Embalaje
BLANCO	NEGRO	TRANSPARENTE			
01769	41769	91769	Cuchara degustación	121x42x20	50
01770	41770	91770	Cucharilla	90x22x4	100
01760	41760	91760	Vaso degustación	51x51x33 / 5 cl	12
01761	41761	91761	Vaso degustación	51x51x55 / 9 cl	12
01771	41771	91771	Brocheta	82x3x3	250
01772	41772	91772	Brocheta	200x3x3	250
01764	41764	91764	Plato llano	127x127x15	20
01762	41762	91762	Plato llano pequeño	80x80x15	25
01765	41765	91765	Plato hondo	127x127x15 / 25 cl	20
01763	41763	91763	Plato hondo pequeño	70x70x23 / 7 cl	25
01768	41768	91768	Bandeja individual	200x70x8	20
01766	41766	91766	Bandeja cuadrada	280x280x15	12
01767	41767	91767	Bandeja rectangular	480x240x17	6



Brocheta



Plato llano



Plato hondo



Bandeja individual



Bandeja Cuadrada



Bandeja Rectangular

Vajilla Catering Nature

Referencia	Referencia	Referencia	Descripción	Dimensiones (mm)	Embalaje
BLANCO	NEGRO	TRANSPARENTE			
01734	41734	91734	Cuchara degustación	119x40x20	100
01739	41739	91739	Cucharilla	98x20x11	250
01735	41735	91735	Vaso degustación	56x43 / 5 cl	50
01736	41736	91736	Vaso degustación	60x64 / 9 cl	50
01746	41746	91746	Vaso degustación	82x60 / 25 cl	50
01740	41740	91740	Pincho	88x15x6	250
01741	41741	91741	Brocheta	196x15x6	250
01744	41744	91744	Plato llano	97x79x15	50
01745	41745	91745	Plato hondo	90x84x32	50
01743	41743	91743	Plato individual	160x104x18	20
01742	41742	91742	Bandeja degustación	340x209x19	12



Cuchara degustación



Cucharilla



Pincho



Brocheta



Vaso degustación



Plato llano



Plato hondo



Plato individual



Bandeja degustación



Servicio cóctel desechable

Platillo flat

V8846018-19 - Negro
V8846018-11 - Blanco
8x6,6 cm / 10 ml
Embalaje: 50 ud

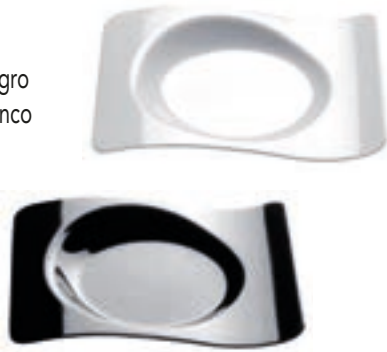

Cuchara estándar

V8842717C - Transparente
V8842717C-19 - Negro
V8842717C-11 - Blanco
12 cm / 15 ml
Embalaje: 30 ud



Mini copa cuadrada

V8846006-21 - Transparente
V8846006-19 - Negro
V8846006-11 - Blanco
7x7 cm / 90 ml
Embalaje: 25 ud



Cuchara fish

V8842718C - Transparente
V8842718C-19 - Negro
V8842718V-11 - Blanco
12 cm / 20 ml
Embalaje: 30 ud



Vaso cónico alto

V8846005-21 - Transparente
V8846005-19 - Negro
V8846005-11 - Blanco
5 cm Ø / 75 ml
Embalaje: 25 ud



Mini cuchara

V8842716C - Transparente
V8842716C-19 - Negro
V8842716C-11 - Blanco
100 mm
Embalaje: 50 ud



Vaso cónico maxi

V8846023-21 - Transparente
V8846023-19 - Negro
V8846023-11 - Blanco
5,5 cm Ø / 100 ml
Embalaje: 10 ud



Mini tenedor

V8842715C - Transparente
V8842715C-19 - Negro
V8842715C-11 - Blanco
100 mm
Embalaje: 50 ud



Brocheta bambú lazo

001010204 - Largo 90 mm
001010205 - Largo 150 mm
Embalaje: 200 ud



Brocheta rojo/negro

001010135 - Largo 120 mm
Embalaje: 200 ud



Brocheta bambú golf

001010127 - Largo 105 mm
001010128 - Largo 150 mm
Embalaje: 200 ud



Brocheta bola color

001010130 - Largo 120 mm
001010129 - Largo 120 mm
Embalaje: 200 ud



Bol rombo

V8846001-21 - Transparente
V8846001-19 - Negro
V8846001-11 - Blanco
5,5x5,6 cm / 95 ml
Embalaje: 25 ud



Chupito zero

V8846025-21 - Transparente
V8846025-19 - Negro
V8846025-11 - Blanco
5,3 cm Ø / 60 ml
Embalaje: 15 ud



Bandeja pequeña

V8846010-21 - Transparente
V8846010-19 - Negro
V8846010-11 - Blanco
6,5x6,5 cm / 45 ml
Embalaje: 25 ud



Bol cubo

V8846027-21 - Transparente
V8846027-19 - Negro
V8846027-11 - Blanco
4,7x4,7 cm / 60 ml
Embalaje: 15 ud

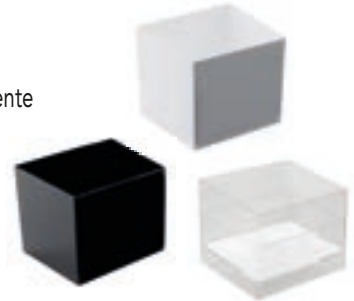

Bandeja mediana

V8846011-21 - Transparente
V8846011-19 - Negro
V8846011-11 - Blanco
13x13 cm / 130 ml
Embalaje: 12 ud

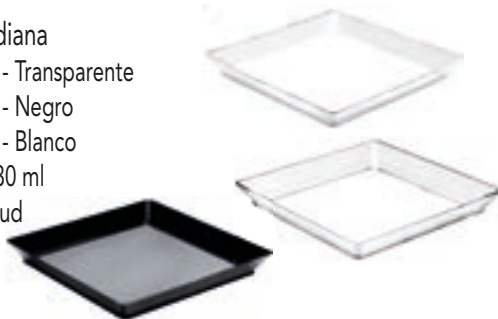

Bol rectangular

V8846028-21 - Transparente
V8846028-19 - Negro
V8846028-11 - Blanco
5,8x4,5 cm / 60 ml
Embalaje: 15 ud



Bol pequeño

V8846012-21 - Transparente
V8846012-19 - Negro
V8846012-11 - Blanco
8,3 cm Ø / 150 ml
Embalaje: 12 ud



Bol pagoda mediano

V8846100-21 - Transparente
V8846100-19 - Negro
V8846100-11 - Blanco
8x8 cm / 200 ml
Embalaje: 12 ud

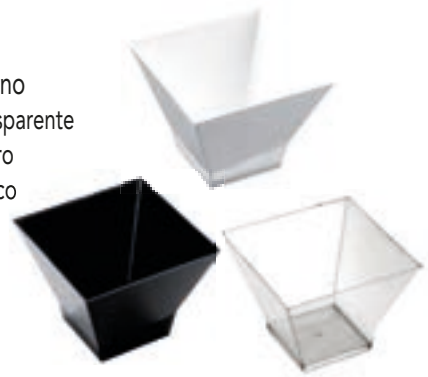

Bol mini

V8846026-21 - Transparente
V8846026-19 - Negro
V8846026-11 - Blanco
6,7 cm Ø / 60 ml
Embalaje: 10 ud



Bol pagoda pequeño

V8846104-21 - Transparente
V8846104-19 - Negro
V8846104-11 - Blanco
7x7 cm / 150 ml
Embalaje: 12 ud



Bol mediano

V8846013-21 - Transparente
V8846013-19 - Negro
V8846013-11 - Blanco
11 cm Ø / 220 ml
Embalaje: 6 ud



Bol pagoda pequeño

V8846021-21 - Transparente
V8846021-19 - Negro
V8846021-11 - Blanco
6,7x6,7 cm / 120 ml
Embalaje: 25 ud



Policarbonato colectividades



B-1



B-2



Referencia	Descripción	Medidas
66930	Bandeja isotérmica B-1	55x38 cm
66943	Bandeja isotérmica B-2	38x28 cm



Referencia	Descripción	Medidas
66933	Plato llano c/tapa	22 cm Ø
66934	Plato hondo c/tapa	19 cm Ø - 45 cl



Referencia	Descripción	Medidas
66937	Bol c/tapa	13 cm Ø x h6,5 cm - 45 cl
66948	Bol c/tapa doble pared	12,5 cm Ø x h7cm - 50 cl



Referencia	Descripción	Medidas
66931	Carro portabandejas 20 ud	90x62x148 cm



Referencia	Descripción	Medidas
66936	Taza desayuno	9 cm Ø x h7 cm - 30 cl
66949	Taza desayuno doble pared	8,5 cm Ø x h7,5 cm - 25 cl

MAQUINARIA

Machinery • Machinerie • Macchine • Maschinen



Trituradores



Trituradores profesionales Sammic

- Potencias de 250 a 750 W.
- Brazos trituradores de 200 a 600 mm y brazos batidores.
- Brazo triturador: para preparar purés (verduras, patatas, potajes, etc.), cremas (cebolla, pimientos, tomate, pastelera, etc.) y todo tipo de salsas.
- Brazo batidor: para montar nata, preparar merengues, chantilly, salsa mahonesa y genovesa, tortillas, crepes, soufflés, etc.
- TR/BM-350: variador de velocidad con sistema inteligente de control de revoluciones, consiguiendo la máxima potencia del motor en todo momento.
- Fabricados en materiales muy resistentes y de primera calidad.
- Brazos fabricados totalmente en inoxidable.
- Diseño ergonómico.
- Funcionamiento sencillo y facilidad de limpieza.

	TR-200	TR-250	TR-350		TR-550		TR-750	TR/BM-250			TR/BM-350	
			BN	BL	BL	BXL		BXS	BS	BB-250	BN	BB-350
GUIA DE SELECCIÓN RECIPIENTES HASTA (LITROS)	10	15	60	70	100	150	200	10	15	2-30 Claras huevo	60	2-50 Claras huevo
CARACTERÍSTICAS ALIMENT. ELÉCTRICA	230V / 50-60 Hz / 1~											
POTENCIA (W)	250	250	350	350	550	550	750	250	250	250	350	350
VELOCIDAD (R.P.M.) FIJA (EN LÍQUIDO)	9.000	9.000	9.000	9.000	9.000	9.000	9.000					
VARIABLE (EN LÍQUIDO)	-	-	-	-	-	-	-	1500- 9.000	1500- 9.000	130- 1.500	1500- 9.000	130- 1.500
DIMENSIONES (MM)												
BRAZO TRITURADOR	200	290	420	500	500	585	600	200	290		420	
Ø CAZOLETA	65	82	94	94	94	105	118	65	82		94	
BRAZO BATIDOR										300		396
TOTAL	485	550	732	805	805	885	935	460	550	560	732	705
PESO NETO (KG)	1.9	1.9	3.35	3.55	3.95	4.15	4.25	1.5	1.9	2.3	3.35	3.5

Cortadoras hortalizas

Las cortadoras de hortalizas Sammic son máquinas muy robustas que están fabricadas en acero inoxidable con materiales de la más alta calidad, aptos para el contacto con alimentos. La gama comprende distintos tipos de bloques motor y cabezales, que permiten alcanzar una producción de hasta 1.000 Kg/h, adecuándose a las necesidades de cada usuario.

El motor, ventilado, permite un trabajo continuo. El panel de mandos estanco, es electrónico y de uso muy intuitivo.

Las cortadoras de hortalizas CA de Sammic pueden dotarse de una amplia gama de discos y rejillas de 205 mm de diámetro. La tecnología empleada en su fabricación asegura un corte uniforme, requiriéndose un menor esfuerzo para el corte, minimizando el deterioro del alimento y generándose menos líquido. Combinando los discos y rejillas entre sí, se pueden obtener más de 70 tipos de cortes y rallados diferentes. La gama de cortadoras de hortalizas Sammic se ha diseñado teniendo en cuenta factores ergonómicos y los flujos de trabajo más habituales.



Más de 70 tipos de cortes y rallados

	CA-301	CA-301 VV	CA-401	CA-401 VV	CA-601
		GUÍA DE SELECCIÓN			
CUBIERTOS (DESDE / HASTA)	100-450	100-450	100-600	100-600	200-1000
PRODUCCIÓN HORA	150-450 Kg	150-500 Kg	200-650 Kg	200-650 Kg	500-1000 Kg
		CARACTERÍSTICAS			
ÁREA BOCA ENTRADA (CORTADORA)	136 cm ²	136 cm ²	286 cm ²	286 cm ²	273 cm ²
VELOCIDAD MOTOR	365 rpm	365-1000 rpm	365 rpm	365-1000 rpm	365-730 rpm
		POTENCIA			
MONOFÁSICA	550W	1500W	550W	1500W	-
TRIFÁSICA	370W	-	550W	-	750W
		DIMENSIONES EXTERIORES			
DIMENSIONES EXTERIORES	389x405x544 mm	391x409x567 mm	389x382x646 mm	391x400x667 mm	431x418x767 mm
PESO NETO	21 Kg	28 Kg	24 Kg	30 Kg	26 Kg

Cutters-Emulsionadores

Picadoras-mezcladoras con muchas posibilidades. Máquina industrial para cortar, triturar, mezclar, amasar cualquier alimento en segundos: hierbas y verduras, masas diversas, carnes crudas o cocinadas, pescado, surimi, frutas, frutos secos, hielo, etc.

CUTTERS CK:

2 velocidades y 5 u 8 litros de capacidad.

Los cutters CK-5 y CK-8 de Sammic son máquinas muy robustas que están enteramente construidas en materiales alimentarios. El caldero, fácilmente extraíble, está fabricado en acero inoxidable de gran calidad y cuenta con asa ergonómica así como una tapa de policarbonato altamente resistente provisto de un orificio que permite añadir líquidos en funcionamiento.

El panel de mandos, electrónico y estanco, es de uso muy intuitivo y está provisto de un pulsador de ráfagas.

Los cutters Sammic están equipados con un microrruptor de seguridad que evita la puesta en marcha si el caldero o la tapa no están en la posición adecuada.

Los cutters CK son muy fáciles de limpiar y están homologadas por NSF Internacional.

Opcionalmente pueden dotarse del exclusivo revolvero "cut&mix", que permite obtener un producto más homogéneo a la vez que evita el sobrecalentamiento del mismo.

CUTTERS-EMULSIONADORES CKE:

Velocidad variable, 5 u 8 litros de capacidad y revolvero "cut&mix", incorporado.

La gama CKE difiere de la CK en que está especialmente concebido para trabajar con líquidos y emulsionar. Para ello, cuenta con velocidad variable, el panel de mandos incluye temporizador y la tapa incluye el revolvero "cut&mix".

El resto de características coincide con las de la gama CK.

GAMA COMPACTA: SK/SKE

Gama de cutter SK-3 y cutter-emulsionador SKE-3, con caldero de 3 litros.

Cuentan con un recipiente de acero inoxidable extraíble y tapa con orificio para añadir líquidos en funcionamiento. El panel de mandos es electrónico y cuentan con variador de velocidad con sistema continuo. Los cutters SK/SKE están provistos de microrruptor de seguridad.



	CK-5	CK-8	CKE-5	CKE-8	SK-3	SKE-3
GUÍA DE SELECCIÓN						
CUBIERTOS (DESDE / HASTA)	20-75	20-100	20-75	20-100	10-25	10-30
CAPACIDAD MÁXIMA DE PRODUCTO	3 Kg	4 Kg	3 Kg	4 Kg	1 Kg	2 Kg
CARACTERÍSTICAS						
CAPACIDAD DEL CALDERO	5.5 l	8 l	5.5 l	8 l	3 l	3 l
DIMENSIONES DEL CALDERO	Ø 240x150 mm	Ø 240x240 mm	Ø 240x150 mm	Ø 240x240 mm	Ø 160x160 mm	Ø 160x160 mm
POTENCIA TOTAL	900-1500 W	900-1500 W	1250 W	1250 W	500 W	500 W
2 VELOCIDADES	sí	sí	-	-	-	-
VELOCIDAD VARIABLE	-	-	sí	sí	sí	sí
VELOCIDAD, MIN-MAX	1500 / 3000 rpm	1500 / 3000 rpm	385 / 3000 rpm	385 / 3000 rpm	450 / 3000 rpm	450 / 3000 rpm
DIMENSIONES EXTERIORES	284x374x439 mm	284x374x488 mm	284x374x439 mm	284x374x488 mm	240x370x305 mm	240x370x305 mm
PESO NETO	21.6 Kg	23 Kg	23 Kg	24 Kg	11 Kg	11 Kg

Freidoras FA



FA-6

- Construida totalmente en acero inoxidable AISI 304 (18/10).
- Cuba interior embutida de AISI 304, sin ángulos y con las marcas de MÁX-MÍN del nivel de aceite.
- Cabezal eléctrico extraíble para facilitar su limpieza.
- Termostato de trabajo regulable hasta 200°C / 20 A.
- Termostato de seguridad con rearme manual 230°C.
- Resistencia blindada en acero inoxidable.
- Sistema de fijación de la cesta para escurrir el aceite en el cabezal.
- Cesta reforzada en malla y varilla en acero inoxidable AISI 304 (18/10).
- Patas antideslizantes.
- Modelo FA10: con grifo para evacuar el aceite.



FA-10

Modelo	Dimensiones LxPxH (mm)	Potencia kw	Voltaje V	Capacidad L	Cesta LxPxH (mm)	Raciones 200 g
FA4	180x425x180	2	230	4	120x240x85	20
FA6	265x425x225	3	230	6	210x235x95	30
FA6+6	530x425x225	3+3	230	6+6	210x235x95	60
FA8	265x425x225	4	230	8	210x235x110	45
FA8+8	530x425x225	4+4	230	8+8	210x235x110	90
FA10	265x425x225	4	230	10	210x235x110	50
FA10+10	530x425x225	4+4	230	10+10	210x235x110	100
FA10 MAX 230	265x425x225	6	230	10	210x235x110	75
FA10+10 MAX 230	530x425x225	6+6	230	10+10	210x235x110	150
FA10 MAX 400	265x425x225	6	400	10	210x235x110	75
FA10+10 MAX 400	530x425x225	6+6	400	10+10	210x235x110	150



Freidoras FAH



FAH-17

- Construida totalmente en acero inoxidable AISI 304 (18/10).
- Cuba interior embutida de AISI 304, sin ángulos y con las marcas de MÁX-MÍN del nivel de aceite.
- Cabezal eléctrico extraíble para facilitar su limpieza.
- Termostato de trabajo regulable hasta 200°C / 20 A.
- Termostato de seguridad con rearme manual 230°C.
- Resistencia blindada en acero inoxidable.
- Con grifo incorporado para evacuar el aceite.
- Sistema de elevación de la resistencia para calentar el volumen de aceite necesario para freír.
- Cesta reforzada en malla y varilla en acero inoxidable AISI 304 (18/10).
- Patas regulables en altura antideslizantes.
- Modelo FAR: de alto rendimiento.

Modelo	Dimensiones LxPxH (mm)	Potencia kw	Voltaje V	Capacidad L	Cesta LxPxH (mm)	Raciones 200 g
FAH10 230	325x525x360	6	230	10	185x245x110	91
FAH10+10 230	650x525x360	6+6	230	10+10	185x245x110	182
FAH10 400	325x525x360	6	400	10	185x245x110	91
FAH10+10 400	650x525x360	6+6	400	10+10	185x245x110	182
FAH17 230	360x560x850	6	230	17	205x285x120	110
FAH17+17 230	724x560x850	6+6	230	17+17	205x285x120	220
FAH17 400	360x560x850	7	400	17	205x285x120	110
FAH17+17 400	724x560x850	7+7	400	17+17	205x285x120	220
FAH25	410x645x850	15	400	25	235x325x140	260
FAH25+25	824x645x850	15+15	400	25+25	235x325x140	520
FAH35	531x645x850	15	400	35	350x325x150	275
FAH35+35	1065x645x850	15+15	400	35+35	350x325x150	550
FAR17	360x560x850	17	400	17	205x285x120	267
FAR25	410x645x850	25	400	25	235x325x140	434



FAH-10

Freidoras FH

Sistema agua-aceite

– El agua ocupa la parte que está en el fondo de la cuba mientras que el aceite, debido a su densidad, está por encima del agua. Gracias a este tipo de sistema, los residuos que se desprenden de la fritura van hacia el fondo de la cuba y al contactar con el agua los absorbe y se depositan en el fondo. Por este motivo podemos freír distintos alimentos sin mezclar los sabores.

– Su limpieza y ahorro de aceite es mayor, ya que cada vez que cambiamos el agua evacuamos los residuos de los alimentos, no es necesario filtrar el aceite.

– Nuestro sistema de resistencia móvil, al poder situar el elemento calefactor a la altura deseada, nos permite una serie de ventajas:

- Ahorro de energía: calentamos sólo el volumen de aceite necesario para cada fritura.
- Mayor rapidez: con menos potencia tenemos una respuesta rápida, ya que calentamos un menor volumen de aceite.
- Mayor duración de aceite: al no calentar todo el volumen, el aceite tiene una mayor duración.

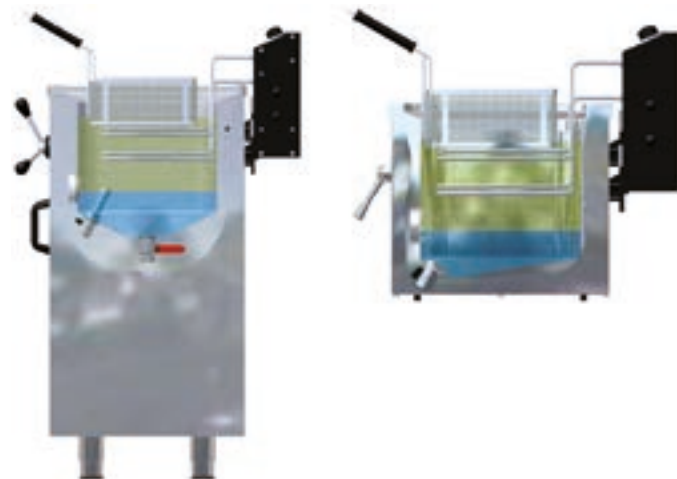

- Construida totalmente en acero inoxidable AISI 304 (18/10).
- Cuba interior embutida de AISI 304, sin ángulos y con las marcas de MÁX-MÍN del nivel de aceite.
- Sistema de agua y aceite: permite el ahorro de aceite y no mezcla sabores.
- Cabezal eléctrico extraíble para facilitar su limpieza.
- Termostato de trabajo regulable hasta 200°C / 20A.
- Termostato de seguridad con rearme manual 230°C.
- Resistencia blindada en acero inoxidable.
- Con grifo incorporado para evacuar el aceite.
- Sistema elevación de la resistencia para calentar el volumen de aceite necesario para freír.
- Cesta reforzada en malla y varilla en acero inoxidable AISI 304 (18/10).
- Patas regulables en altura y antideslizantes.

Modelo	Dimensiones LxPxH (mm)	Potencia kw	Voltaje V	Capacidad Agua (L)	Capacidad Aceite (L)	Capacidad Total (L)	Cesta LxPxH (mm)	Raciones 200 g
F10	325x440x360	4	230	3,5	10	13,5	185x245x110	55
F10+10	650x440x360	4+4	230	3,5+3,5	10+10	13,5+13,5	185x245x110	110
FH10 230	325x525x360	6	230	3,5	10	13,5	185x245x110	91
FH10+10 230	650x525x360	6+6	230	3,5+3,5	10+10	13,5+13,5	185x245x110	182
FH10 400	325x525x360	6	400	3,5	10	13,5	185x245x110	91
FH10+10 400	650x525x360	6+6	400	3,5+3,5	10+10	13,5+13,5	185x245x110	182
FH17 230	360x560x850	6	230	4,5	15	19,5	205x285x120	110
FH17+17 230	724x560x850	6+6	230	4,5+4,5	15+15	19,5+19,5	205x285x120	220
FH17 400	360x560x850	7	400	4,5	15	19,5	205x285x120	110
FH17+17 400	724x560x850	7+7	400	4,5+4,5	15+15	19,5+19,5	205x285x120	220
FH25	410x645x850	15	400	8	23	31	235x325x140	260
FH25+25	824x645x850	15+15	400	8+8	23+23	31+31	235x325x140	520
FH35	531x645x850	15	400	14	30	44	350x325x150	275
FH35+35	1065x645x850	15+15	400	14+14	30+30	44+44	350x325x150	550

- Hasta 30 kilos de patatas por operación.
- Pueden pelar zanahorias y otros alimentos similares.
- Efectúan pelado por abrasión, que desgasta la superficie del producto por rozamiento.
- Equipados con cuadro de mandos con pulsador de arranque, parada y temporizador de 0 a 6 min.
- Las peladoras se pueden complementar con un soporte y filtro anti-espuma para las peladuras.



Gama aluminio

- Las peladoras de patatas PP-PPC están fabricadas en aluminio altamente resistente y realizan el pelado por abrasión, el cual desgasta la superficie del producto por rozamiento.
- El abrasivo es sumamente resistente y duradero y tanto el plato como el lateral del cilindro están recubiertos por el mismo.
- El cilindro es orientable y todos los modelos cuentan con un cuadro de mandos con pulsador de arranque, parada y temporizador de 0 a 6 minutos.
- Los modelos PPC cuentan con una toma de accesorios en posición fija.



Gama inoxidable

- Modelos de entre 10 y 30 kg de capacidad y sirven para pelar patatas, zanahorias u otros productos similares.
- Construídos en acero inoxidable, revolvedores laterales con abrasivo de carburo de silicio (aprobado por NSF). El plato, de aluminio está recubierto con abrasivo de carburo de silicio (aprobado por NSF) y es fácilmente desmontable para su limpieza.
- Tapa, transparente en policarbonato altamente resistente.
- Puerta de salida, cierre hermético y dispositivo de seguridad.
- Cuadro de mandos con temporizador 0-6 min.
- Auto-arrastre de residuos al desagüe y sistema anti-retorno en la entrada de agua.

	PP(C)-6+	PP(C)-12+	M5	PI-10	PI-20	PI-30	PES-20
GUÍA DE SELECCIÓN							
CUBIERTOS (DESDE / HASTA)	30-150	60-200	10-80	60-200	100-300	>200	100-300
CARACTERÍSTICAS							
CAPACIDAD DE CARGA POR CICLO	6 Kg	12 Kg	5 Kg	10 Kg	20 Kg	30 Kg	20 Kg
PRODUCCIÓN HORA (MAX)	150 Kg	270 Kg	100 Kg	240 Kg	480 Kg	720 Kg	300 Kg
POTENCIA							
MONOFÁSICA	400(PP)W 550 (PPC)W	400(PP)W 550 (PPC)W	300W	550W	550W	730W	550W
TRIFÁSICA	370(PP)W 550(PPC)W	370(PP)W 550(PPC)W	-	370W	550W	730W	550W
DIMENSIONES EXTERIORES							
DIMENSIONES EXTERIORES	395x700x433 mm	395x700x503 mm	333x367x490 mm	433x635x625 mm	433x635x735 mm	622x760x950 mm	433x635x735 mm
DIMENSIONES EXTERNAS CON SOPORTE	411x700x945 mm	411x700x1015 mm	425x555x965 mm	433x638x1040 mm	433x638x1155 mm	546x760x1255 mm	433x638x1155 mm

Cortadoras fiambre

Transmisión correa

- Construido totalmente en aluminio anodizado.
- Motor ventilado con transmisión mediante una correa.
- Dispositivo de seguridad incorporado.
- Afilador de cuchilla extraíble para facilitar su limpieza.
- Cuchilla de acero inoxidable AISI 304 (18/10).
- Protector de Plexiglass en el carro incorporado.
- Soporte del carro que se desliza por cojinetes y rodamientos de bolas.
- Cuchilla protegida por la parte interior y perimetral.
- Patas antideslizantes.



Modelo	Dimensiones LxPxH (mm)	Potencia W	Voltaje V	Ø Cuchilla	Longitud corte LxPxH (mm)	Altura corte	Espesor corte (mm)
C220S	445x363x342	140	230	Ø220	134	130	0 - 12
C250S	490x380x360	170	230	Ø250	185	140	0 - 12
C275S	505x410x375	280	230	Ø275	192	146	0 - 15
C300S	570x480x420	320	230	Ø300	202	160	0 - 15

Transmisión engranajes

- Fabricadas con aluminio pulido y protegidas de la oxidación anódica.
- Cuchilla cóncava de cromo duro.
- Afilador de precisión.
- Deslizamiento del carro mediante rodamientos.
- Seguridad: Anillo, bloqueo de carro y extractor de cuchilla.
- Motor ventilado de gran potencia.
- Los componentes en contacto con los alimentos totalmente desmontables para facilitar su limpieza.

	GC-220	GC-250	GC-275	GC-300
DIÁMETRO DE CUCHILLA	220 mm	250 mm	275 mm	300 mm
CAPACIDAD CORTE	150x200 mm	190x250 mm	210x250 mm	220x260 mm
ESPESOR CORTE	0-10 mm	0-15 mm	0-15 mm	0-15 mm
RECORRIDO DEL CARRO	205 mm	260 mm	260 mm	270 mm
POTENCIA TOTAL	250W	300W	300W	300W
DIMENSIONES EXTERIORES				
ANCHO	470 mm	580 mm	580 mm	600 mm
FONDO	380 mm	470 mm	470 mm	480 mm
ALTO	340 mm	370 mm	380 mm	420 mm



Cortadora CCE - Especial para carne. Cuchilla vertical.

Picadoras carne



- Picadoras de carne profesionales, son ideales para hostelería, colectividades y alimentación.
- Producciones desde 100 hasta 425 Kg/h, según modelo.
- Los modelos PS-12/22/32 cuentan con carrocería y tolvas construídas en acero inoxidable.
- Los motores son ventilados y de gran solidez.
- En el modelo compacto PS-12, el grupo picador está incluido y es de aluminio.
- En los modelos PS-22/32, el grupo picador puede ser de aluminio o acero inoxidable.
- El grupo motor y el grupo picador se piden por separado.
- Todos los modelos se suministran con 1 cuchilla y 1 placa.



	PS-12	PS-22	PS-32	PS-22R	PS-32R
		GUÍA DE SELECCIÓN			
PRODUCCIÓN/HORA (MAX)	100 Kg	280 Kg	425 Kg	250 Kg	450 Kg
		CARACTERÍSTICAS			
DIÁMETRO DE PLACA	70 mm	82 mm	98 mm	82 mm	98 mm
POTENCIA TOTAL	440W	740-1100W	1500W	1100W	2200W
		DIMENSIONES EXTERIORES			
DIMENSIONES EXTERIORES	227x470x410 mm	310x440x480 mm	310x460x480 mm	310x438x508 mm	325x544x553 mm
PESO NETO	18 Kg	31 Kg	33 Kg	40 Kg	74 Kg

Exprimidores



	ECM	ECP
PRODUCCIÓN NARANJAS/HORA	200	200
POTENCIA TOTAL	130W	130W
PRESIÓN POR PALANCA	-	sí
PRESIÓN MANUAL	sí	-
DIMENSIONES EXTERIORES	200x280x340 mm	200x300x370 mm
PESO NETO	8.5 Kg	10 Kg

Referencia	Tensión	Potencia	Velocidad	Dimensiones
69286	220-240 V	180 W	1.350 r.p.m.	31x22x35 cm
69283	220-240 V	230 W	980 r.p.m.	28x20x40 cm

Tostadores



Referencia	Producción de tostadas (máx)	Ancho de cinta	Potencia Total	Dimensiones Exteriores	Peso Neto
TP-10	120	—	2000 W	500x280x295 mm	8,5 kg
TP-20	240	—	2800 W	500x280x390 mm	11 kg
ST-252	500	270 mm	2100 W	340x410x360-410 mm	16,5 kg
ST-352	750	370 mm	2800 W	460x410x360-410 mm	19,5 kg

Termos leche

- Construido totalmente en acero inoxidable 18/10.
- Diseñado para ocupar poco espacio.
- Ideales para leche, caldo, agua, té, café, etc.
- Resistencia blindadas de acero inoxidable.
- Depósito desmontable mediante rosca.
- Regulación automática de temperatura.
- Grifo de evacuación regulable de dos posiciones.
- Patas antideslizantes.



Modelo	Dimensiones LxPxH (mm)	Potencia W	Consumo W	Voltaje V	Capacidad L
TM3	232x232x130	1	789	230	3
TM6	265x265x525	1,5	1181	230	6
TM12	525x265x525	3	2368	230	6+6
TM20	380x380x600	3	2368	230	20



Referencia	Dimensiones	Capacidad	Potencia
HM910	483x400x281 mm	24 L	900 W
HM1001	520x444x312 mm	25 L	1000 W



Referencia	Dimensiones	Capacidad	Potencia
CM1519 Manual	559x464x372 mm	26 L	1500 W
CM1529 Digital	559x464x372 mm	26 L	1500 W
CM1919 Manual	559x464x372 mm	26 L	1850 W
CM1929 Digital	559x464x372 mm	26 L	1850 W



Referencia	Dimensiones	Capacidad	Potencia
69325	510x430x315 mm	25 L	1000 W



Batidoras Vaso



TORQ
2.0



TBB145E
1490W-24500RPM
Vaso 1,4 Lt
Controles mecánicos
50-75 servicios/día

TBB160E
1490W-24500RPM
Vaso 1,4 Lt
Controles electrónicos
50-75 servicios/día

TBB175E
1490W-24500RPM
Vaso 1,4 Lt
Controles electrónicos
Control velocidad variable
50-75 servicios/día



MX1000XTXEE/MX1000XTPEE
2600W-30000RPM
Vaso 1,4 Lt / 2,0 Lt
Controles mecánicos
+75 servicios/día

MX1100XTXSEE/MX1100XTPSEE
2600W-45000RPM
Vaso 1,4 Lt / 2,0 Lt
Controles electrónicos
+75 servicios/día

MX1500XTXSEE/MX1500XTPSEE
2600W-45000RPM
Vaso 1,4 Lt / 2,0 Lt
Controles electrónicos programables
+75 servicios/día



MX1200XTXEE
2600W-20000RPM
Vaso 1,4 Lt / 2,0 Lt
Controles electrónicos
Control velocidad variable
+75 servicios/día

WARING
COMMERCIAL

Opcional

Campana Antiruidos
SE500 - Para 1,4 Lt
SE1000 - Para 2,0 Lt





- Acabado exterior en aluminio anodizado negro.
- Elegante cristal curvo con templado y abatible.
- Cuba interior embutida de AISI 304, sin ángulos.
- Ajuste de temperatura por termostato digital regulable.
- Puertas correderas alta resistencia.
- Compresor hermético con condensador ventilado tropicalizado.
- Sistema de iluminación por tira de LED.



Onix

Dimensiones (mm)	Potencia (W)	Temperatura (°C)
1146x390x224	160	+2/+6
1487x390x224	160	+2/+6
1826x390x224	160	+2/+6

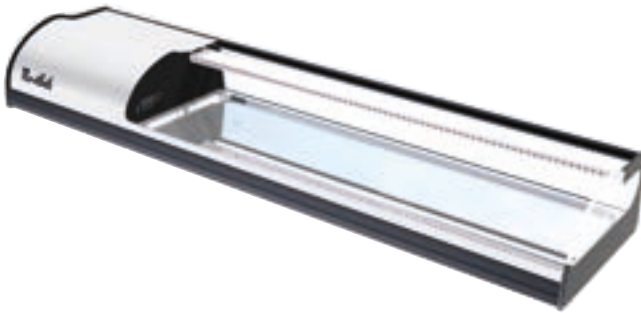

Onix 2 pisos

Bandejas	Dimensiones (mm)	Potencia (W)	Temperatura (°C)
6	1487x390x330	160	+2/+6
8	1826x390x330	160	+2/+6

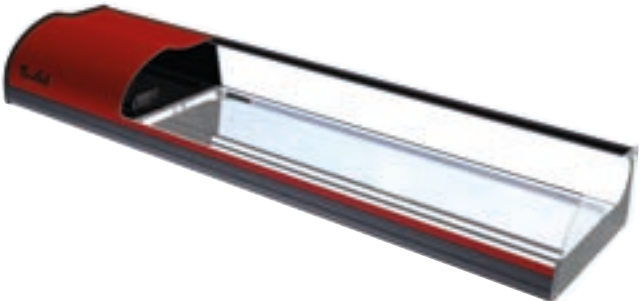

Onix placa fría

Dimensiones (mm)	Potencia (W)	Temperatura (°C)
1146x390x224	160	+2/+6
1487x390x224	160	+2/+6
1826x390x224	160	+2/+6



Onix sushi

Bandejas	Dimensiones (mm)	Potencia (W)	Temperatura (°C)
4	1146x390x224	160	+2/+6
6	1487x390x330	160	+2/+6
8	1826x390x330	160	+2/+6



Onix sushi tapa fría

Dimensiones (mm)	Potencia (W)	Temperatura (°C)
1146x390x224	160	+2/+6
1487x390x224	160	+2/+6
1826x390x224	160	+2/+6

Fregaderos



- Fabricado en acero inoxidable.
- Cubas embutidas.
- Válvula de desagüe y tubo rebosadero incluido.
- Peto posterior.
- Bastidor de acero inoxidable.
- Estantes (1-2) opcionales.
- Longitudes de 600 a 2500 mm.
- Anchos de 500/600/700 mm.
- Varias opciones de cubas (1-2-3) y escurridores (1-2).
- Disponibles modelos con cubas de alta capacidad.

DISTFORM
FOODSERVICE TECHNOLOGY



Grifería



- Gran variedad de modelos.
- Convencionales o ducha.

Lavamanos

- Modelos de pared o pie.



Mesas trabajo



- Encimeras de acero inoxidable satinado.
- Murales (con peto) o centrales (sin peto).
- Patas de 40x40 mm regulables en altura (850/900 mm).
- Estantes (1-2) opcionales.
- Longitudes de 600 a 2400 mm.
- Anchos de 500/600/700/800 mm.
- Cajones y módulos de cajones opcionales.
- Mesas angulares.
- Puertas y ruedas opcionales.



DISTFORM
FOODSERVICE TECHNOLOGY

Máquinas hielo



- Cubito compacto de alta calidad.
- Sistema de fabricación mediante inyectoros metálicos.
- Exterior en acero inox AISI 304 y carrocería monoblock en inox con aislamiento en poliuretano inyectado a alta presión libre de CFC'S.
- Cuba y puerta en ABS alimentario.
- Medidas sin patas, altura pata regulable +/-110-150 mm.
- Entrada agua Ø 3/4 y salida Ø 24 mm.
- Gas refrigerante R404a.
- Tensión / Frecuencia: 220-240V/50 Hz.

Producciones de 20 a 155 kg/día

 **infrico**

Lavavajillas



Lavavasos
Cesta: 40x40 cm.
Ciclos: 90/120/150/180 seg.
Producción: hasta 40 cestas/h.
Brazos de lavado de acero inox.
Dosificadores de líquidos incorporados.



Lavavajillas capota
Cesta: 50x50 cm.
Ciclos: 90/120/150/180 seg.
Producción: hasta 60 cestas/h.
Brazos de lavado de acero inox.
Dosificadores de líquidos incorporados.
Mesas de entrada y salida.



Lavavajillas
Cesta: 50x50 cm.
Ciclos: 90/120/150/180 seg.
Producción: hasta 40 cestas/h.
Brazos de lavado de acero inox.
Dosificadores de líquidos incorporados.



Lavautensilios
Cesta: 67x60 cm.
Ciclos: 120/240/360/540 seg.
Producción: hasta 30 cestas/h.
Brazos de lavado de acero inox.
Dosificadores de líquidos incorporados.

Los nuevos procesos en la cocina

Las cada vez más exigentes normativas alimentarias y la necesidad de ofrecer un producto de calidad con las mayores condiciones higiénicas y sanitarias, ha llevado a la necesidad de la creación nuevos procesos en las cocinas industriales.

Tanto en servicios de catering y grandes salones como en la pequeña y mediana restauración estos procesos son indispensables para mantener tanto la productividad de la cocina como la calidad del producto final.

La combinación de envasadora al vacío, horno mixto y abatidor de temperatura simplifica todas estas necesidades en el mínimo espacio y con la máxima fiabilidad.

Con estos procesos podemos conseguir evitar la aparición de bacterias en el proceso de enfriado y la utilización de técnicas de cocción a baja temperatura con un mínimo de inversión económica y un aprovechamiento eficaz del espacio.



Envasado al vacío



Cocción (65°C-110°C)



Abatir (-20°C)



Cocción (65°C-300°C)



Abatir (-4°C)



Envasado al vacío



Regenerar (65°C)



mychef. evolution



Cocción en calor seco De 30 a 300° C

Para cocciones que requieren un aporte continuo de aire caliente seco hasta una temperatura de 300°C, sin humedad. Consigue texturas crujientes, esponjosas y jugosas en carnes asadas, filetes, pescados, precocinados, pizzas y productos de panadería.



Cocción en modo mixto De 30 a 300° C

Para cocciones con calor seco y húmedo a la vez. Permite cocciones más rápidas, más respetuosas con el alimento y con menos mermas, evitando que se resequen los alimentos. El mejor resultado en guisados, asados y gratinados.



Cocción al vapor De 30 a 130° C

mychef evolution genera con la mayor rapidez el vapor más denso del mercado. Además, es el único horno que genera un vapor puro y esterilizado totalmente libre de patógenos. Cocina a baja temperatura, al vapor, pocha, rehoga o blanquea. Obtendrás resultados excelentes en verduras y pescados respetando sus cualidades organolépticas y nutricionales. Y todo ello con un aspecto y color brillantes.



distform
foodservice solutions



MySmartCooking

SISTEMA DE COCCIÓN INTELIGENTE

El sistema de cocción inteligente MySmartCooking hace que cocinar sea más fácil que nunca. Solo tienes que seleccionar el alimento por categoría, escoger el tipo de cocción, y ajustar parámetros como dorado, tamaño y punto. mychef calcula automáticamente el resto.



MyCookingPlanner

COCCIONES SIMULTÁNEAS INTELIGENTES

Con MyCookingPlanner, puedes cocinar simultáneamente alimentos con diferentes tiempos de cocción. La mejor solución para aprovechar al máximo la productividad de tu horno y ahorrar energía.

La opción Multilevel realiza la cocción de varias recetas independientes que se inician al mismo tiempo pero que tienen momentos de finalización. Cada bandeja tendrá su cocción independiente.

Con la opción Just in time podrás realizar múltiples recetas con diferentes tiempos de cocción que necesitas que finalicen al mismo tiempo.



SmartClima Plus

EL SISTEMA DE GENERACIÓN Y GESTIÓN DE VAPOR MÁS AVANZADO

Vapor rápido, denso y seguro.

Gracias a los avanzados sensores de SmartClima Plus, el horno monitoriza hasta diez veces por segundo las condiciones reales de humedad en la cámara de cocción, en función del tipo y la cantidad de alimentos. SmartClima Plus ajusta automáticamente la humedad, inyectando o extrayendo vapor para obtener el resultado deseado, una cocción siempre perfecta.



MyCloud

GESTIONA TU HORNO DESDE TU SMARTPHONE

El sistema MyCloud conecta tu horno con tu móvil, tu tablet o tu ordenador. Descárgate la aplicación mychef cloud y gestiona tu horno desde cualquier lugar. O accede al sistema cloud desde el área privada de la web MyCloud, donde puedes también crear, guardar o modificar recetas y enviarlas a tu horno simplemente pulsando un botón.



El sistema patentado TSC (Thermal Stability Control) ofrece una estabilidad de la temperatura en la cámara de cocción sin rival. El resultado son platos con texturas más apetitosas y un gran ahorro energético. El Sistema TSC mide la temperatura en la cámara de cocción varias veces por segundo y transfiere la cantidad de energía necesaria para ofrecer la máxima estabilidad de la temperatura sin apenas oscilaciones ($\pm 0,2^{\circ}\text{C}$). El resultado es una precisión inigualable en las cocciones a baja temperatura, la cocina al vacío, las deshidrataciones, la pasteurización, y la cocina al vapor. El producto final mantiene todas sus propiedades organolépticas y unos colores más brillantes, todo ello con una menor pérdida de peso, respetando el producto al máximo.



El sistema de autolimpieza inteligente MyCare elimina cualquier tipo de suciedad automáticamente y sin supervisión. Según el estado de suciedad de la cámara, MyCare te propone el programa de limpieza más eficiente. Además, gracias al sistema patentado UltraVioletSteam, el último ciclo de lavado genera vapor libre de patógenos por toda la cámara, dejándola esterilizada para una máxima seguridad alimentaria. MyCare hace posible un mayor ahorro energético con un menor consumo de detergente y menos emisiones tóxicas.



Serie S

Modelo	6 GN-2/3	6 GN-1/1	9 GN-1/1	6T GN-1/1
Capacidad	6 GN-2/3	6 GN-1/1	9 GN-1/1	6 GN-1/1
Comidas/día	20-80	30-100	50-150	30-100
Ancho	520	520	520	520
Fondo	623	800	800	595
Alto	662	662	822	662
Potencia	5,6 KW	7 KW	10,40 KW	7 KW
Tensión	230V/400V	230V/400V	230V/400V	230V/400V

Serie L

Los hornos mychef evolution serie L son la opción perfecta para los grandes restaurantes, hoteles y colectividades. Pensados para atender a un gran número de comensales. Consulte sus características en su distribuidor Hoterali@.

Envasadoras vacío

iSensor

distform
EQUIPOS PARA LA INDUSTRIA ALIMENTARIA



MODO AUTOMÁTICO

¡Introduce el alimento, baja la tapa y listo!

Envasar nunca ha sido tan fácil. Con el modo automático de iSensor, simplemente introduce el alimento dentro de la bolsa y baja la tapa. No es necesario configurar ningún parámetro ni hacer reajustes. La envasadora inteligente iSensor calcula el vacío perfecto según el tipo de alimento, el espesor de la bolsa y las condiciones atmosféricas. Sus sensores inteligentes controlan todo el proceso y el resultado es siempre el mismo. Un envasado perfecto y eficiente, sin ningún tipo de supervisión.



MODO MANUAL

Vac +

Vacío extra para alimentos porosos. Añade un tiempo de vacío adicional una vez alcanzado el 100% de vacío y fuerza la salida del aire del interior de los alimentos porosos. Una aplicación muy interesante son las impregnaciones, técnica que sustituye el aire del alimento poroso por un líquido.

Envasado con gas inerte

Para alimentos frescos o delicados. Envasa cualquier tipo de alimento respetando la seguridad alimentaria y garantizando la calidad de los alimentos frescos más delicados: pescado, mariscos, verduras....

Soft Air

Para el envasado de alimentos delicados o especiales. Entrada progresiva del aire para una mejor adaptabilidad de la bolsa de vacío al producto a envasar. Ideal para productos que pueden deformarse o romperse con el envasado.



Modelo	Medidas exteriores (mm)	Bomba de vacío (m ³ /h)	Alimentación (V/L+N/Hz)	Potencia (KW)	Medidas cámara (mm)	Longitud soldadura (mm)	Posición barra soldadura
S	388x491x382	BUSCH 6	230/L+N/50-60	0,25	328x385x162	315	
M	475x561x454	BUSCH 10	230/L+N/50-60	0,30	412x453x200	405	
M	475x561x454	BUSCH 16	230/L+N/50-60	0,55	412x453x200	405	
M	475x561x454	BUSCH 20	230/L+N/50-60	0,75	412x453x200	405	
L	620x571x469	BUSCH 20	230/L+N/50-60	0,75	560x465x210	455	
L	620x571x469	BUSCH 20	230/L+N/50-60	0,75	560x465x210	455+455	



TekChill distform

El abatidor de temperatura TekChill es un valioso aliado en las cocinas profesionales, permite mantener intacta la frescura de los alimentos con la máxima higiene y flexibilidad, planificar la producción y evitar desperdicios permitiendo considerables beneficios en términos de tiempo y reducción de costes.

- Fabricados en acero inoxidable AISI 304 en estructura monobloc.
- Panel de control digital y teclado de membrana.
- Sonda corazón, incluida.
- Control por tiempo o por sonda.
- Cambio de mano en puerta, opcional.
- Guías extraíbles y cantos redondeados para una fácil limpieza.
- Incorpora desagüe en la parte inferior.
- Sistema automático de descarche.
- Pase automático a fase de mantenimiento al final del ciclo.
- Ciclo de pre-enfriamiento a -30°C.
- Para bandejas de dimensiones GN 1/1 (todos los modelos) y EN (600x400) especial pastelería en modelos 5 GN 1/1 T, 10 GN 1/1 y 15 GN 1/1.



Abatimiento positivo

El abatimiento positivo permite proteger los alimentos contra la agresión bacteriana, prolongando su periodo de conservación y evitando pérdidas de peso en los productos. La temperatura en el corazón de los alimentos pasa de 90°C a 3°C en 90 minutos.

Abatimiento negativo

El proceso de abatimiento negativo (congelación) se realiza mediante la formación de microcristales que mantienen intacta la estructura celular del alimento, garantizando así su conservación durante un largo periodo de tiempo. La temperatura en el corazón de los alimentos pasa de 90°C a -18°C en 240 minutos.



Modelo	Medidas totales (mm)	Capacidad	Tensión (V/L+N/Hz)	Potencia (W)	Potencia frigorífica (W)	Rendimiento +3/-18°C
TekChill 3GN 1/1	650x670x670	3GN 1/1	230/1/50	975	613	10/7 kg
TekChill 5GN 1/1 Long.*	520x850x880	5GN 1/1 L	230/1/50	1185	807	15/10 kg
TekChill 5GN 1/1 Transv.**	800x700x900	5GN 1/1 T 5 EN (600x400)	230/1/50	1185	807	18/11 kg
TekChill 10GN 1/1	800x780x1700	10GN 1/1 10 EN (600x400)	230/1/50	2010	1547	34/22 kg
TekChill 15GN 1/1	800x780x2000	15GN 1/1 15 EN (600x400)	400/3L+N/50	3820	2933	50/38 kg

* Ideal para el apilado de un horno MyChef / ** Ideal para el apilado de un horno MyChef T

Botelleros refrigerados



- Refrigeración R134a.
- Interior y exterior en acero inoxidable.
- Fondo embutido con desagüe.
- Evaporador estático de cobre y aletas de aluminio.
- Control de temperatura por termostato.
- Patas regulables en altura.
- Compresor hermético ventilado.
- Separadores verticales en rejilla de acero platinado.
- Fondo: 550 mm.
- Longitudes: 1000/1500/2000 mm.
- Puertas: 2/3/4.
- Temperatura de trabajo: +2°C/+6°C.

Mesas refrigeradas



- Refrigeración R134a.
- Control electrónico y digital de la temperatura de desercarche.
- Patas de acero regulables en altura.
- Interior y exterior en acero inox AISI 201.
- Trasera en galvanizado.
- Dispositivo automático de cierre.
- Compresor hermético ventilado.
- Evaporador de tubo de cobre.

Opciones

- Ruedas.
- Fregadero.
- Puertas de cristal.
- Kit cajones, (uno o más módulos).
- Encimera granito.



Armarios refrigerados



MÚLTIPLES POSIBILIDADES

- De 1 a 6 puertas.
- Refrigeración y congelación.
- Medidas estándar o gastronorm.
- Refrigeración o congelación.
- Armarios especiales para pescado.
- Puertas de cristal.

infrico



Cocción



- Líneas de cocción modulares con todos los elementos necesarios.
- Murales 550/750/900 mm de fondo.
- Centrales.



- Cocina.
- Frytop.
- Freidora.
- Baño maría.
- Marmitas.
- Sartén Basculante.
- Neutros.
- Muebles bajos para elementos de sobremesa.
- Planchas.
- Cuecepastas.

 **TECNOINOX**

TEXTIL Y VESTUARIO

*Textile and Clothing • Textile et Vêtements
Tessile e Abbigliamento • Textil und Kleidung*



Vestuario

chaqueta cocinero



Ref. 908- Manga Corta
Color blanco
Sarga 200 gr/m²
65% poliéster - 35% algodón
Tallas: XS-S-M-L-XL-XXL-YL
Unisex
Boton Forrado



Ref. 907 - Manga Larga
Color blanco
Sarga 200 gr/m²
65% poliéster - 35% algodón
Tallas: XS-S-M-L-XL-XXL-YL
Unisex
Boton Forrado

Ref. 917M
Color negro
Popelin 120 gr/m²
65% poliéster - 35% algodón
Tallas: XXS-XS-S-M-L-XL-XXL-YL
Unisex
Boton Cosido

Ref. 916
Color blanco
Popelin 120 gr/m²
65% poliéster - 35% algodón
Tallas: XXS-XS-S-M-L-XL-XXL-YL
Unisex
Boton Cosido



Ref. 9307 Teramo
9 colores
Sarga 200 gr/m²
65% poliéster - 35% algodón
Tallas: XS-S-M-L-XL-XXL-YL
Unisex
Botón Chupete



Ref. 9191 - Catania
9 colores
Sarga 200 gr/m²
65% poliéster - 35% algodón
Tallas: XS-S-M-L-XL-XXL-YL
Chica
Botón Chupete



Rojo - 105



Fucsia - 125



Malva - 119



Morado - 136



Turquesa - 115



Verde - 121



Albero - 128



Gris Perla - 117



Gris Marengo - 139



pantalon cocinero



Ref. 770
 Color Raya Luto
 Vichy 118 gr/m²
 65% poliéster - 35% algodón
 Tallas: 36-64
 Unisex



Ref. 771
 Color Cuadro Marino
 Vichy 118 gr/m²
 65% poliéster - 35% algodón
 Tallas: XXS-XS-S-M-L-XL-XXL-YL
 Unisex



Pantalón microfibra
 Antibacterias. Repelente a los líquidos. Alta transpirabilidad. No necesita planchar. No se alteran los colores. Tolerancia a salpicaduras de lejía. Seca muy rápido. Lavable a 90°.

Ref. 7006
 Goma y cordón
 5 Colores
 Microfibra 148 gr/m²
 100% poliéster
 Tallas: XS-S-M-L-XL-XXL-YL
 Unisex



Gorros



GORRO GRAN CHEF

Ref. 4481V
 16 colores
 65% poliéster - 35% algodón
 Tallas: Única
 Regulable con velcro
 Unisex



Ref. 4482V
 17 diseños
 65% poliéster - 35% algodón
 Tallas: Única
 Regulable con velcro
 Unisex



Delantales

Delantal Francés con Bolsillo



Ref. 118B
90x75 cm
Sarga 200 gr/m²
65% poliéster - 35% algodón
Tallas: Única
Unisex



Delantal Peto con bolsillo



Ref. 116BC
90x75 cm
Sarga 200 gr/m²
65% poliéster - 35% algodón
Tallas: Única
Unisex

Delantal sin Peto con bolsillo



Ref. 11745B
50x75 cm
Sarga 200 gr/m²
65% poliéster - 35% algodón
Tallas: Única
Unisex



Bandanas



Ref. 4471
Múltiples colores y diseños
65% poliéster - 35% algodón
Tallas: Única
Unisex



Camisas



Ref. 2658
Popelin 120 gr/m²
65% poliéster - 35% algodón
Tallas: 38-50
Chico

Ref. 2481
Popelin 120 gr/m²
65% poliéster - 35% algodón
Tallas: XS-S-M-L-XL-XXL-YL
Chica



pantalones



Ref. 2035
Sarga Bioelástica 225 gr/m²
96% poliéster - 4% elastano
Tallas: 36-56
Negro-Marino-Gris Marengo
Chica

Ref. 7779
Micofibra 135 gr/m²
100 % poliéster
Tallas: 36-60
Negro
Chico

chaqueta cocinero gama alta



Hermes - 9320
Blanco
100 % algodón - 170 gr/m²
Tallas: XS-YL
Chico



Galatea - 9334
Blanco
100 % algodón - 170 gr/m²
Tallas: XS-XXL
Chica



Zeus - 9323
Blanco/Negro
100 % algodón - 170 gr/m²
Tallas: XS-YL
Chico



Carites - 9346
Negro
65 Poliester - 35 % algodón 210 gr/m²
Tallas: XS-YL
Chico

Icaro - 9330
Blanco/Negro
100 % algodón - 170 gr/m²
Tallas: XS-YL
Chico



Artemisa - 9355
Blanco
65 Poliester - 35 % algodón 210 gr/m²
Tallas: XS-XXL
Chica





Calzado pensado para actividades que requieren estar mucho y tiempo de pié, con una durabilidad, ergonomía y diseño del más alto nivel.

- Antideslizante.
- Lavable.
- Absorción de energía en el talón.
- Confort articular y térmico (elimina casi el 90% del calor que genera el pié).
- Impermeable.
- Resistente a químicos.

mycodeor



Diseño original y sencillo. Ligero y flexible.
Colores: Blanco-Negro
Tallas: de 34 a 48



Planeta



Destinado especialmente para uso femenino. Perfecto para uso en sala, recepción o congresos.
Colores: Negro
Tallas: de 35 a 42



sírio



Perfecta ergonomía y ajuste al pié. Atractivo diseño indicado para actividades de cara al público. Extremada sensación de comodidad y ligereza.
Colores: Negro-Marrón
Tallas: de 34 a 48



velcro



Sistema de cierre mediante solapa de velcro. Gran sujeción. Ligero y flexible, adecuado para cocinas, office y personal sanitario.
Colores: Negro-Blanco
Tallas: de 35 a 46



seguridad



Protección en puntera. Destaca por su extraordinaria ligereza, inusual en zapatos de este nivel de protección. Su comodidad contrasta con la rigidez del zapato tradicional de seguridad.
Colores: Negro-Blanco
Tallas: de 35 a 48



Mantelería



Cuadro clásico

50% poliéster / 50% algodón
Ancho pieza: 3,20 m
Diseño clásico



Marrón



Crema



Amarillo



Verde



Rojo



Azul

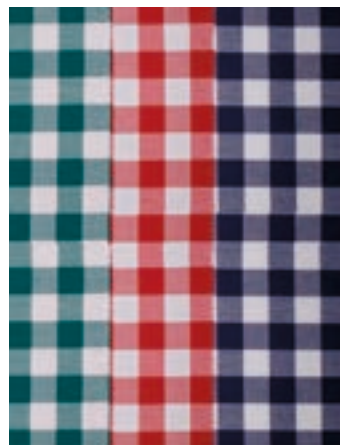

París

65% poliéster / 35% algodón
Ancho pieza: 3,20 m



Lila



Royal



Negro



Vino



Arena



Cobre



Mercurio



Verde



Arena 2



Corteza



carré

65% poliéster / 35% algodón

Ancho pieza: 3,20 m

Diseño informal

Reversible

Fácil lavado



Cobre



Arena



Negro



Verde



rústico

50% poliéster / 50% algodón

Ancho pieza - 3,20 m

Bajo peso

Baja fijación de manchas

Fácil lavado

Extraordinaria solidez de los colores



Blanco



Crudo



Lino



Blanco



Cuerda



Vainilla



Naranja



Rioja



Avellana



Chocolate



Gris



Negro



satén

50% poliéster / 50% algodón

Ancho pieza: 3,20 m

Amplísimo colorido - Alto gramaje - Artículo clásico



Arena



Amarillo



Añil



Azu

Azul Marino



Azul



Azulón



Negro



Naranja



Oro



Pistacho



Rioja



Rojo



Salmón



Tabaco



Teja



Vainilla



Verde Botella



Verde



Marrón



Gris Perla



Beige



Berenjena



Blanco



Burdeos



Chocolate



spiral

65% poliéster / 35% algodón

Ancho pieza: 3,20 m

Diseño informal

Colores actuales

Reversible

Fácil lavado



Royal



Negro



Arena



Corteza



Crema



Rosa Palo



Vino



CONSUMIBLES

Consumables • Consommables
Materiali di Consumo • Verbrauchsmaterial



Aparatos



Secamanos



Código	Descripción	Serie
AA13000	Secamanos pulsador	ABS
AA14000	Secamanos óptico	ABS
AA19000/AA19600	Secamanos ave óptico alto rendimiento blanco/negro	ABS
AA25050/AA25650	Secamanos alto rendimiento jet tifon blanco/negro	ABS
AA25550/AA25950	Secamanos alto alto rendimiento jet tifón plata/grafito	ABS
AA15000/15500	Secamanos pulsador inox satinado/brillo	INOX
AA16500/16000	Secamanos óptico inox satinado/brillo	INOX
AA18000/AA18500	Secamanos ave óptico alto rendimiento brillo/satinado	INOX



Serie Smart



Código	Descripción	Serie
AE57000/AE57600	Dispensador industrial higiénico blanco/negro	SMART
AG47000/AG47600	Dispensador de papel mecha blanco/negro	SMART
AH37000/AH37600	Dispensador de toallas zig-zag blanco/negro	SMART
AC27050/AC27650	Jab. depósito smart Jofel blanco/negro	SMART
AC96000	Jab. depósito smart Jofel	SMART



Serie ABS



Código	Descripción	Serie
AC70000/70600	Jabonera Aitana blanco/negro	ABS
AC79000/AC79500	Jabonera Aitana inox brillo/satinado	ABS
AC91050	Dosificador óptico depósito jabón rellenable	ABS
AC91060	Dosificador óptico depósito espuma rellenable	ABS
AC91000	Dosificador óptico depósito con carga	ABS
AH33000	Toallero azur	ABS
AG21050	Box secamanos mecha clásico fume	ABS
AG40000	Box secamanos	ABS
AG16500/AG15500	Dispensador palanca blanco/fume	ABS
AG17550/AG18550	Dispensador automático top blanco/fume	ABS
AG56000/56600/57000	Disp. papel autocortante ABS blanco/negro/fume	ABS



Serie Inox



Código	Descripción	Serie
AC54000/54500	Jabonera futura Inox satinada/brillo	INOX
AC79000/AC79500	Jabonera Aitana inox brillo/satinado	INOX
AE25000/25500	Portarrollos futura inox satin./brillo	INOX
AH25000/25500	Toallero futura inox satinado/brillo	INOX
AG45000/45500	Disp. mecha box satinado/brillo	INOX
AG59000	Disp. papel autocortante	INOX



Celulosa

Hoterali@

Bobina secamanos

DESCRIPCIÓN	EMBALAJE
Bobina 2/C pasta celulosa 1 kg	6 U.
Bobina 2/C pasta celulosa 1,2 kg	6 U.
Bobina 2/C pasta Eco 1,2 kg	6 U.
Bobina 2/C pasta Eco 1 kg	6 U.



Higiénico industrial



DESCRIPCIÓN	EMBALAJE
Bobina 2/C pasta celulosa 0,45 kg	18 U.
Bobina 2/C Eco 0,45 kg	18 U.

Bobina industrial

DESCRIPCIÓN	EMBALAJE
Bobina 2/C pasta celulosa 6 kg	2 U.
Bobina 2/C Eco 5 kg	2 U.



Toallas secamanos



DESCRIPCIÓN	PAQUETE	EMBALAJE
Toalla Z reciclada natural	196	3.920 U.
Toalla Z reciclada blanca	196	3.920 U.
Toalla tisú 2 C	196	3.920 U.

Higiénico doméstico

DESCRIPCIÓN	METROS BOBINA	EMBALAJE
Higiénico doméstico 2/C pasta celulosa	36	96 U.



Servilletas Tisú



COLORES	17x17 TISÚ 1 CAPA MINISERVIS	20x20 TISÚ 2 CAPAS
	400 unidades paquete 16.000 unidades caja 24 cajas palet	100 unidades paquete 5.000 unidades caja 24 cajas palet
<input type="checkbox"/>	BLANCO SULFITO	X
<input type="checkbox"/>	BLANCO TISÚ	X
<input type="checkbox"/>	BURDEOS	X
<input type="checkbox"/>	NEGRO	X



COLORES	30x30 TISÚ 1 CAPA	30x30 TISÚ 2 CAPAS
	100 unidades paquete 4.000 unidades caja 28 cajas palet	100 unidades paquete 3.200 unidades caja 24 cajas palet
<input type="checkbox"/>	BLANCO	X



COLORES	33x33 TISÚ 1 CAPA	33x33 TISÚ 2 CAPAS
	100 unidades paquete 4.800 unidades caja 15 cajas palet	100 unidades paquete 3.000 unidades caja 20 cajas palet
<input type="checkbox"/>	BLANCO	X
<input type="checkbox"/>	AMARILLO	X
<input type="checkbox"/>	ROJO	X
<input type="checkbox"/>	AZUL	X
<input type="checkbox"/>	VERDE	X
<input type="checkbox"/>	BURDEOS	X
<input type="checkbox"/>	NEGRO	X

*50 Serv. paquete, 800 serv. caja 72 cajas palet

COLORES	40x40 TISÚ 2 CAPAS	40x40 TISÚ 2 CAPAS PLEGADO 1/8
	100 unidades paquete 2.400 unidades caja 20 cajas palet	100 unidades paquete 2.400 unidades caja 15 cajas palet
<input type="checkbox"/>	BLANCO	X
<input type="checkbox"/>	BLANCO ECOLABEL	X
<input type="checkbox"/>	AMARILLO	X
<input type="checkbox"/>	SALMÓN	X
<input type="checkbox"/>	ROJO	X
<input type="checkbox"/>	AZUL	X
<input type="checkbox"/>	VERDE	X
<input type="checkbox"/>	BURDEOS	X
<input type="checkbox"/>	NEGRO	X



Servilletas punta&punta

Las servilletas Punta&Punta tienen más resistencia y cuerpo que una servilleta dos capas convencional. El acabado Punta&Punta se caracteriza por la unión de las dos capas de las servilletas mediante una gota de cola, este tipo de gofrado mejora la apariencia de la servilleta y hace que las capas no se separen. Este sistema de unión de capas también aumenta la capacidad de absorción, con lo que se mejora el rendimiento de la servilleta. Las servilletas Punta&Punta reducen el consumo facilitan el ahorro.



COLORES



40x40 P&P
2 CAPAS

100 unidades paquete
1.600 unidades caja
20 cajas palet

	BLANCO	T222150
	CARAMEL	T222156
	CREMA	T222181
	AMARILLO	T222177
	GRIS	T222178
	ROSA	T222182
	NARANJA	T222174
	KIWI	T222176
	FUCSIA	T222180
	ROJO	T222153
	TURQUESA	T222183
	AZUL	T222152
	VERDE	T222159
	BURDEOS	T222151
	CACAO	T222157
	NEGRO	T222154

Manteles celulosa blanco

MANTEL DE CELULOSA CORTADO

Celulosa 37 gr.

REFERENCIA	Medidas	Embalaje
W240100*	Mantel 30x40	500 ud.
W241100	Mantel 35x49	1.000 ud.
W241600	Mantel 80x80	500 ud.
W241912	Mantel 100x100	500 ud.
W242000	Mantel 100x120	500 ud.
W242100	Mantel 120x120	500 ud.
W241940	Mantel 100x140	400 ud.

* Manteles 30 x 40 con cenefa consultar.

MANTEL DE CELULOSA ROLLO BLANCO

Celulosa 37 gr.

REFERENCIA	Medidas	Celulosa	Embalaje
R251192	Rollo mantel 100 cm x 50 m	37 gr.	1 ud.
R251095	Rollo mantel 100 cm x 100 m	37 gr.	1 ud.
R258990	Rollo mantel 120 cm x 10 m	48 gr.	1 ud.
R251201	Rollo mantel 120 cm x 25 m	48 gr.	1 ud.
R251202	Rollo mantel 120 cm x 50 m	48 gr.	1 ud.
R251207*	Rollo mantel 120 cm x 100 m	48 gr.	1 ud.

* Colores a consultar en la medida 120 cm x 100 m



La gama GC Class de servilletas y manteles en Tisuclass es la marca del grupo para vestir la mesa con distinción. El Tisuclass es un material de un solo uso no excluyente de la tela, ya que se puede utilizar como complemento de la misma. Cada vez más el ambiente, la atmósfera, o el entorno tienen mayor valor diferenciador a la hora de prestar servicios de restauración.

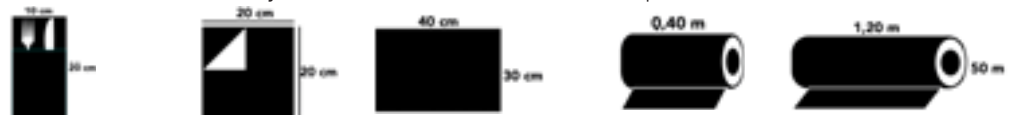

MESA CLASS COLORES		KANGUR 40x40 cm.	SERVILLETAS 40x40 cm.	MANTELES 30x40 cm.	DUETO 0,40x50 m.	ROLLO MANTEL 1,20x50 m.
Uds. paquete/Uds. caja Cajas palet		50 / 600 49	50 / 600 49	300 54	3 rollo caja/60rollos box 2 box palet	1 rollo caja/20rollos box 2 box palet
	BLANCO		T224050	W230099	R251243	R251197
	STONE	T260098	T224065		R251296	
	GRIS	T260007	T224062		R251254	R251220
	CARAMEL	T260009	T224054	W230411	R251248	R251219
	KIWI	T260006	T224060	W230410	R251251	R251222
	TERRACOTA	T260012	T224053	W230406*	R251245	R251215
	ROJO	T260013	T224051		R251247	R251217
	TURQUESA	T260011	T224064		R251258	R251224*
	AZUL	T260014	T224055	W230402*	R251244	R251198
	BURDEOS	T260004	T224057	W230409	R251242	R251195
	BERENJENA	T260005	T224061	W230408	R251250	R251221
	CACAO	T260008	T224059	W230412	R251249	R251218
	GRAFITO	T260010	T224063	W230414	R251257	R251223*
	NEGRO	T260003	T224052	W230405	R251246	R251216
	CENEFA			W230103		

* Bajo pedido. Consultar tiempo de entrega.



PREMIUM	SERVILLETAS 20x20 cm.*	SERV. 30x40 cm. Plegado 1/6	SERV. 40x40 cm. Plegado 1/8	KANGUR 34x40 cm.	KANGUR 47x47 cm.	SERVILLETAS 47x47 cm.
Uds. paquete/Uds. caja Cajas palet	60 / 2160 49	70 / 840 49	50 / 600 49	50 / 600 49	50 / 500 49	50 / 500 49
	BLANCO	T202000	T261121	T260018	T261125	T224147
	BURDEOS	T202001				
	NEGRO	T202002		T260019		

* Cada caja de servilletas 20 x 20 incluye 8 cajas dispensadoras.

TisuClass®
AIRLAID

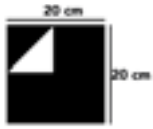

SERV. SIENA
40x40 cm.

SERV. PARÍS
40x40 cm.

SERV. LUXE
40x40 cm.

SERV. CON
CENEFA 40x40
cm.

KANGUR
SIDNEY
40x40 cm.

KANGUR
SIENA
40x40 cm.

Uds. paquete/Uds. caja
Cajas palet

50 / 600
49

50 / 600
49

50 / 600
49

50 / 600
49

50 / 600
49

50 / 600
49



BLANCO

T221440

T221436

T260000

T000505

GRIS

T221442

T000506

CARAMEL

T221443

T000507

NEGRO

T221452

T260001

BURDEOS

T221457

T221447

T260002

Línea Ecológica

Ecológico es una nueva gama de productos tisú hecha a partir de 100% fibra reciclada. El papel que utilizamos se fabrica a partir de las fibras de celulosa presentes en los envases de cartón, lo que le confiere un característico color marrón.



Servilletas
Línea Ecológica

40x40 cm.
P&P 2 capas

30x40 cm.
P&P 2 capas
Plegado 1/6

33x33 cm.
P&P 2 capas

30x40 cm.
2 capas
Maxi servis

20x20 cm.
P&P 2 capas

17x17 cm.
1 capa
Mini servis

Uds. paquete/Uds. caja
Cajas palet

100 / 1.600
20

75 / 2.400
20

50 / 1.500
20

50 / 1.500
20

100 / 3.000
42

400 / 16.000
24



NATURE

T222001

T222002

T223300

T221050

T972000

T221099



Nature
Ecofriendly paper



Manteles
Línea Ecológica

MANTEL KRAFT
30x40 cm.
48 grs.

MANTEL KRAFT
35x49 cm.
48 grs.

MANTEL KRAFT
100x100 cm.
48 grs.

MANTEL KRAFT
120x120 cm.
48 grs.

DUETO KRAFT
0,40x50
48 grs

Uds. caja
Cajas palet

2x500
48

1.000
60

3x100
22

300
18

3 rolos caja
60 rollos box/ 2
box palet



NATURE

W240402

W241202

W242200

W242300

R251266

Mantelines

Material 100% reciclado. Impreso con tintas compostables.



REF.	TAMAÑO	g/m2	PACK	CARTÓN/MÍN.
106.40	31 x 43 cm.	48	500 u.	2.000 u.
106.12	31 x 43 cm.	48	500 u.	2.000 u.



Ref.: 106.12

Ref.: 106.40

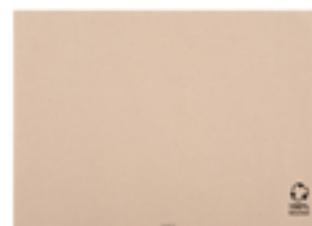

CM	CARTÓN	1 COL				2 COL			3 COL	
		10 C	20 C	50 C	100 C	20 C	50 C	100 C	50 C	100 C
31 X 43	2.000 U	X	X	X	X	X	X	X	X	X

Bolsas SOS kraft natural con asas tipo cordel. Personalizadas.

	cm	Anónimas	Decoradas
Bolsas SOS kraft natural 80 g/m ² Cartón/mín. 250 U.	20 +10 x 29	109.19	142.59
	25 +14 x 32	109.20	142.60
	32 +16 x 31	109.23	214.15
	32 +16 x 43	109.22	109.22



Personalización: precios a consultar en función de la cantidad y número de colores.
Impresión semi-artesanal mediante repicaje (pequeñas cantidades).
Impresión simultánea a la fabricación de las bolsas (grandes cantidades).

Feel Green
Ref.: 142.59



Sin decoración
Ref.: 109.23



Sin decoración
Ref.: 109.19



Arpillera
Ref.: 214.15





Tejido sin tejer 70 g/m² para un solo uso.

Composición: Viscosa y celulosa. Producto de altísima calidad, suave, resistente.

Homogeneidad, tacto agradable y buena resistencia en seco y en húmedo. Parece tela. Certificado de contacto alimentario.



UNICOLOR 70 g/m ²	CANGURO 40x40 cm	SERVILLETAS 20x20 cm.	SERVILLETAS 40x40 cm.	SERVILLETAS 40x40 cm.	ROLLO MANTEL 1,20x25 m.	TU Y YO 0,40x24 m.	MANTELÍN 30x40 cm.
Pack/ cartón mínimo	30 U 720 U	100 U 3.600 U	50 U 600 U	50 U 600 U	1 rollo	20 formats 0,40x1,20 m 6 rollos	200 U 800 U
FUCSIA			195.71		195.74	195.77	
GRIS			195.70	213.56	195.73	195.76	221.47
CREMA	203.93	203.90	179.36	213.59	179.43	179.52	179.60
CHOCOLATE	203.92	203.89	179.27	213.61	179.42	179.49	179.59
MANDARINA			193.86		193.87	193.88	
PISTACHO			193.38		179.45	179.55	
PARMA			179.39	213.62	179.46	179.56	179.70
TURQUESA			194.82		194.83	194.84	
CLARETE			179.37	213.63	179.44	179.53	179.66
AZUL MARINO			802.19				

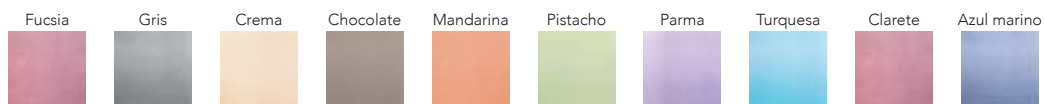

Modelo Aurora



LIKE-LINEN AURORA 70 g/m ²		MEDIDAS	PACK	CARTÓN/MIN.
	SERVILLETAS	40x40 cm	50 U	600 U
	ROLLOS DE MANTEL	1,20x8 m	-	9 R
		1,20x25 m	-	1 R
	MANTELES FORMATO	100x100 cm	20 U	200 U
		120x120 cm	20 U	200 U

Like-Linen®



Envoltorios para recipientes de presentación



Impresas con tintas al agua. Papel antigrasas fino 32 g/m². Pack: 1.000 U., Cartón/mínimo: 4.000 U.



ENVOLTORIOS AMERICAN STYLE	Fitipaldi rojo	Fitipaldi negro	Times	Feel Green 34 g/m ²
31 X 31 cm	186.28	186.29	186.30	186.31
31 X 38 cm	186.32	186.33	186.34	186.35

Personalización: Precios a consultar en función de la cantidad y número de colores. Pedido mínimo: 28.000 U.

Cajas americanas estancas

Envases de alta calidad para platos preparados, pastelería

Con ventana

Colores	1.350 ml Pack: 50 U. Cartón/min.: 300 U. Base inf.: 15,3 x 12,1 cm. Base sup.: 17,2 x 13,9 cm. Altura: 6,4 cm.	1.980 ml Pack: 50 U. Cartón/min.: 200 U. Base inf.: 19,8 x 14 cm. Base sup.: 21,7 x 16 cm. Altura: 6,4 cm.
	Volare	--
Blanco	216.68	--
Negro	216.69	205.43
Feel green	--	205.44
Neutro	216.70	--



Sin ventana

	780 ml (280 + 18 PE g/m ²) Pack: 50 U. - Cartón/min.: 450 U. Base inf.: 11,2 x 9 cm. Base sup.: 12,7 x 11,5 cm. Altura: 6,4 cm.	1.350 ml (305 + 18 PE g/m ²) Pack: 50 U. - Cartón/min.: 300 U. Base inf.: 15,3 x 12,1 cm. Base sup.: 17,2 x 13,9 cm. Altura: 6,4 cm.	1.470 ml (305 + 18 PE g/m ²) Pack: 50 U. - Cartón/min.: 200 U. Base inf.: 19,8 x 14 cm. Base sup.: 21,5 x 15,8 cm. Altura: 4,8 cm.	1.980 ml (305 + 18 PE g/m ²) Pack: 50 U. - Cartón/min.: 200 U. Base inf.: 19,8 x 14 cm. Base sup.: 21,7 x 16 cm. Altura: 6,4 cm.	2.910 ml (305 + 18 PE g/m ²) Pack: 35 U. - Cartón/min.: 140 U. Base inf.: 21,7 x 21,7 cm. Base sup.: 23,6 x 23,6 cm. Altura: 6,4 cm.
	211.44	216.65	211.45	211.46	211.47
	131.57	216.66	131.58	131.59	131.61
	131.74	--	131.75	131.76	--
	221.17	216.67	221.18	--	--

Personalización: Precios a consultar en función de la cantidad y número de colores.

Palillos



Ref.: 0010016



Ref.: 1010125

Referencia	Descripción	mm.	Contenido aprox.	Embalaje
1320014	Palillo redondo 2 puntas "Picnic"	65 x 2	800 U.	100 estuches (5 x 20)
1010115	Palillo redondo 1 punta	100 x 2,2	500 U.	100 estuches (5 x 20)
0010016	Palillo redondo 2 puntas	65 x 2	130 U.	240 palilleros (10 x 24)
1010032	Palillo redondo 2 puntas enfundado	65 x 2,2	1.000 U.	30 estuches (6 x 5)
1010125	Palillo redondo 2 puntas enfundado	65 x 2	1.000 U.	30 estuches (6 x 5)

Brochetas

Referencia	Descripción	mm.	Contenido aprox.	Embalaje
1010133	Pincho brocheta	100 x 2,2	200 U.	150 bolsas (10 x 15)
1010068	Pincho brocheta	200 x 3	50 U.	100 bolsas (2 x 50)



Ref.: 1010133

Cañas



Ref.: 1010173

Referencia	Descripción	cm.	Contenido aprox.	Embalaje
1010173	Caña recta negra		100 U.	100 bolsas (10 x 10)
1010186	Caña recta colores con cuchara		100 U.	100 bolsas (10 x 10)
1010191	Caña flexible negra	230 x 6	100 U.	100 bolsas (10 x 10)

Ecoline

Referencia	Descripción	Contenido aprox.	Embalaje
1010168	Conos de madera 13 cm.	100 U.	25 PVC
1010207	Barcos de madera 22 cm.	50 U.	25 PVC



Ref.: 1010168

Plástico desechable



Vasos blancos NPK



CÓD.	DESCRIPCIÓN	Unds.	Paquetes
3360	Vaso expresso 80 cc	50	84
0455	Vaso café 100 cc	50	20
2906	Vaso agua 200 cc	100	30
1044	Vaso agua 220 cc	100	20
1796	Vaso agua 220 cc base ancha	100	20

No se astilla, es flexible y prácticamente irrompible. Producido con material de alta resistencia que soporta temperaturas entre -20° y 120° C.

Vasos transparentes NPK



CÓD.	DESCRIPCIÓN	Unds.	Paquetes
0506	Vaso agua 200 cc	100	30
0642	Vaso agua 220 cc	100	30
0710	Vaso agua 200 cc base ancha	100	20
0685	Vaso refresco 250 cc	25	18
0760	Vaso cerveza 330 cc	100	30
0641	Vaso cerveza 350 cc	50	25
0588	Vaso cerveza 500 cc	50	16
1502	Vaso litrona 1000 cc	25	20

Vasos inyectados



CÓD.	DESCRIPCIÓN	Unds.	Paquetes
2610	Vaso chupito 40 cc	50	45
2622	Vaso fino 100 cc	50	24
2641	Vaso whisky 250 cc	50	25
2660	Vaso chiquito 210 cc	20	12
2605	Vaso pinta 330 cc	30	17
2688	Vaso sidra 600 cc	20	12
2631	Vaso tubo VIC 300 cc	10	42

Vasos foam

CÓD.	DESCRIPCIÓN	Unds.	Paq.
4128	Vaso foam 200 cc	50	20
4124	Vaso foam 300 cc (café)	50	20
4125	Vaso foam 350 cc (Sundance)	50	20



Tienen gran capacidad de aislamiento térmico.

Copas inyectadas

CÓD.	DESCRIPCIÓN	Unds.	Paq.
3260	Copa cava 150 cc	8	22
2523	Copa cava 150 cc pie negro	6	32
2516	Copa cava 140 cc	6	34
2721	Copa cava 170 cc	8	12

Cubiertos plástico

CÓD.	DESCRIPCIÓN	Unds.	Paq.
2372	Cuchara	100	30
2374	Tenedor	100	30
2373	Cuchillo	100	30
2057	Cuchara café	100	30
2054	Cuchara postre	100	35



Platos plástico



CÓD.	DESCRIPCIÓN	cm	Unds.	Paquetes
1609	Plato plástico	16,5	100	9
1669	Plato plástico	20,5	100	10
1964	Plato plástico	22	100	9
3935	Plato plástico	25	50	8
1969	Plato plástico hondo	22	50	9

Bolsas gofrada envasado al vacío



Descripción	Med. mm.	Pack
Bolsa gofrada	150 x 250	100 U.
Bolsa gofrada	170 x 250	100 U.
Bolsa gofrada	200 x 300	100 U.
Bolsa gofrada	200 x 250	100 U.
Bolsa gofrada	250 x 350	100 U.
Bolsa gofrada	300 x 400	100 U.

Otras medidas a consultar

Bolsas lisas envasado al vacío de 90 y 150 micras

Descripción	Med. mm.	Pack
Bolsa lisa	150 x 200	100 U.
Bolsa lisa	170 x 250	100 U.
Bolsa lisa	200 x 300	100 U.
Bolsa lisa	200 x 250	100 U.
Bolsa lisa	200 x 200	100 U.
Bolsa lisa	250 x 350	100 U.
Bolsa lisa	250 x 300	100 U.
Bolsa lisa	250 x 400	100 U.
Bolsa lisa	300 x 400	100 U.
Bolsa lisa	350 x 500	100 U.

Otras medidas a consultar



Bolsas cocción al vacío

Descripción	Med. mm.	Pack
Bolsa cocción vacío	180 x 250	100 U.
Bolsa cocción vacío	200 x 300	100 U.
Bolsa cocción vacío	300 x 400	100 U.
Bolsa cocción vacío	300 x 500	100 U.

Otras medidas a consultar

Aluminio y Film



Código	Descripción	Medidas cm.
ALUM-HOT30	Bobina aluminio profesional	30 x 13
ALUM-HOT40	Bobina aluminio profesional	40 x 13
FILM-HOT30	Bobina film profesional	30 x 250
FILM-HOT40	Bobina film profesional	45 x 250



Toallitas

Toallita Air bag



Código	Descripción	Pack
HTAIRDON	Toallita air bag Hoteralia (20 cajas de 50 piezas)	1.000 U.

Personalización: precios a consultar en función de la cantidad y número de colores.



Tejido



Código	Descripción	Pack
TLT100	Toallita limón standard	100 U.
TLT500	Toallita limón standard	500 U.

Personalización: precios a consultar en función de la cantidad y número de colores.



Código	Descripción	Pack
TLUXL200	Toallita limón luxury	200 U.
TLUXT200	Toallita té verde luxury	200 U..
TLUXA200	Toallita aloe vera luxury	200 U.

Amenities

Jabones



Descripción	Embal.
Jabón 15 grs. redondo	1.000
Jabón 30 grs. redondo	500
Jabón 10 grs. rectangular	1.000
Jabón 11 grs. rectangular eco	1.000
Jabón 20 grs. glicerina ovalado	500

Tubos-sachets



Descripción	Embal.
Tubo gel o champú 30 ml.	500
Tubo gel o champú 20 ml.	500
Tubo gel o champú (2 en 1) 20 ml.	500
Tubo crema corporal 30 ml.	500
Tubo crema corporal 20 ml.	500
Sachet gel o champú 10 m.	800
Sachet gel o champú (2 en 1) 10 m.	1.000

Otras colecciones



Colección	Descripción	Embal.
	Lustr Zapatos	1.000
	Pañuelos 5 U.	1.000
	Gorro ducha	1.000
ROMERO	Peine recto 2 puas	1.000
JAZMÍN	Set dental + tubo crema	500
GRAFITO	Set afeitar + tubo crema	500
	Set costura	1.000
	Set femenino	1.000

Concentrados

HT DEGRAS

NOVEDAD

Concentrado desengrasante baja alcalinidad



Producto indicado para utilizar en sistemas de disolución de concentrados. El producto resultante es indicado para la limpieza de superficies engrasadas. Puede utilizarse tanto con agua caliente como fría (limpieza de cocinas, superficies, utensilios, etc.) Apto para la industria alimentaria. Apto para uso en la industria alimentaria.

DOSIFICACION Y MODO DE EMPLEO Utilizar mediante sistemas de disolución de concentrado.

Disolución adecuada: entre 1:9 – 1:7

Disolución de uso: 10% - 14%.

COMPOSICION QUIMICA CUALITATIVA Tensioactivos aniónicos
Tensioactivos no iónicos Solventes Álcalis Agentes Secuestrantes
Perfume

PROPIEDADES FISICO-QUIMICAS

Aspecto: Líquido
Color: Amarillo
PH (5%): 11,5 - 12,5
Densidad (20° C): 1,025 +/- 0,01 grs/c.c.

PRESENTACION Envases de 2 Lts.

HT MAN

NOVEDAD

Concentrado lavavajillas



Producto indicado para su utilización en sistemas de disolución de concentrados. El producto resultante es ideal para la limpieza manual de vajillas, cristalerías, cuberterías, etc. Posee un agradable perfume, reengrasantes de la piel y mantiene un elevado poder espumante.

DOSIFICACION Y MODO DE EMPLEO Utilizar en sistemas de disolución de concentrados.

Disolución adecuada: 1:3

Disolución de uso: directo.

COMPOSICION QUIMICA CUALITATIVA Tensioactivos aniónicos
Tensioactivos anfotéricos Perfume Espesante

PROPIEDADES FISICO-QUIMICAS

Aspecto: Líquido viscoso
Color: Verde
Densidad (20°C): 1'04 +/- 0'01 g/cm3
pH (100%): 5'5 – 6'5

PRESENTACION Envases de 2 Lts.

Lavado Vajilla



HTC 100 BLANDAS

Detergente lavado automático

Detergente líquido concentrado, alcalino y exento de espuma para el lavado automático de vajillas y utensilios en lavavajillas industriales (0-15°F).



HTC 101 MEDIAS

Detergente lavado automático semiduras

Detergente líquido concentrado, alcalino y exento de espuma formulado para el lavado automático de vajillas y utensilios en lavavajillas industriales, con aguas semiduras (0-26°F).



HTC 102 MUY DURAS

Detergente lavado automático aguas muy duras

Detergente líquido concentrado, alcalino y exento de espuma formulado para el lavado automático de vajillas y utensilios en lavavajillas industriales, con aguas muy duras (0-57°F).



HTC 104 CRISTAL

Detergente lavado automático especial cristalería

Producto especial para el lavado de cristalería en máquinas automáticas. Alta concentración en secuestrantes y dispersantes, evitando la formación de cercos en las piezas de cristal. Especialmente indicado para el lavado de utensilios de aluminio, así como aditivo para la limpieza en hornos. Exento de espuma, adecuado para aguas de elevada dureza.



HTC 150 BRILL MEDIAS

Abrillantador lavado automático aguas semiduras

Producto de gran concentración destinado a la fase de abrillantado de la vajilla y la cristalería en lavavajillas industriales con aguas semiduras de (0-40°F).



HTC 152 BRILL DURAS

Abrillantador lavado automático aguas muy duras

Producto de gran concentración destinado a la fase de abrillantado de la vajilla y la cristalería en lavavajillas industriales con aguas semiduras de (0-55°F).



HTC 175 DESIN

Desincrustante lavavajillas

Es un producto de marcado carácter ácido que actúa eficazmente como eliminador de incrustaciones de cal. Posee en su composición potentes inhibidores para evitar el ataque sobre los metales. No posee componentes fumantes ni produce gases molestos.



HTC 300 VAJILLAS

Lavavajillas manual concentrado

Detergente concentrado para el lavado manual de ollas, cacerolas, vajillas y todo tipo de utensilios de cocina.

Código	6 kgs.*	12 kgs.	24 kgs.
HTC 100 BLANDA	X	X	X
HTC 101 MEDIAS	X	X	X
HTC 102 MUY DURAS	X	X	X
HTC 104 CRISTAL	X	X	X

* Los 6 kilos vienen en caja de 4 unidades.

Código	1 lt.*	5 lts**	10 lts.	20 lts.
HTC 150 BRIL MEDIAS		X	X	X
HTC 152 BRIL DURAS		X	X	X
HTC 175 DESIN		X		
HTC 300 LAVAVAJILLAS	X	X	X	

* 1 litro viene en caja de 12 unidades.

** Los 5 litros vienen en caja de 4 unidades.

MAPA DE LA DUREZA DEL AGUA



Desengrasantes



HTC 201 GENERAL

Desengrasante general

Desengrasante general para la eliminación de grasas y suciedades en elementos de cocina, campanas extractoras, hornos, pavimentos, etc.



HTC 205 HIGIGRAS

Desengrasante higienizante

Enérgico limpiador desengrasante para todo tipo de residuos orgánicos, grasas, aceites y suciedades muy incrustadas, en trabajos de limpieza cocinas, utensilios, filtros, parrillas, contenedores de basuras, suelos de industrias, talleres, transporte, etc.



HTC 220 FORTE

Desengrasante concentrado

Desengrasante energético utilizable en la limpieza de grasas y suciedades muy incrustadas. Utilizable en frío o en caliente por ser un producto no inflamable.



HTC 200 PLANCHAS

Desengrasante energético para planchas

Desengrasante energético, disuelve fácilmente cualquier tipo de suciedad, incluso grasas carbonizadas. Indicado para limpiar y desengrasar planchas, parrillas, filtros de campana, freidoras, etc. Aplicación en caliente.



HTC 230 PLANCHAS PLUS

Desengrasante para planchas de alto rendimiento

Desengrasante altamente alcalino para superficies muy sucias, grasas incrustadas o quemadas. Especialmente indicado para la limpieza de hornos, planchas, filtros, salamandras muy sucias, etc.



Código	750 cc.*	5 lts.**
HTC 201GENERAL	X	X
HTC 205 HIGIGRAS		X
HTC 220 FORTE		X

* Los 750 cc. vienen en caja de 12 unidades.

** Los 5 litros vienen en caja de 4 unidades.

Código	1,25kg*	6 kg**
HTC 200 PLANCHAS	X	X
HTC 200 PLANCHAS PLUS		X

* 1,25 kgs. viene en caja de 12 unidades

** 6 kgs. viene en caja de 4 unidades

Higienizantes



HTC CLOR

Limpiador superficies clorado

Poderoso limpiador con gran capacidad tensoactiva y higienizante a la vez. Aplicable para limpieza y higienización de suelos de geriátricos, restaurantes, cafeterías y superficies donde se requiere una buena potencia de limpieza y higienización.



HTC VERCLOR

Desinfectante uso alimentario

Producto de alto poder desinfectante y amplio espectro bactericida y germicida. Elimina eficazmente gérmenes y bacterias en frutas y verduras. También se puede utilizar en la cloración de agua para consumo humano.

Código	5 lts.
--------	--------

HTC CLOR X

HTC VERCLOR X

* Los 5 litros viene en caja de 4 unidades.



Suelos



HTS LIMON
Limpiador limón

Producto de amplias aplicaciones en la limpieza de suelos en mármol, terrazo, gres, mosaico, etc. Posee un agradable aroma a limón, dejando una sensación de frescura en los lugares donde se utiliza.



HTS FLORAL
Limpiador floral

Limpiador que posee en su composición una mezcla equilibrada de tensioactivos anionicos y no iónicos, ideal para aplicar en todo tipo de suelos (terrazo, cerámica, suelos sintéticos, etc.).



HTS MANZANA
Limpiador manzana

Producto de amplias aplicaciones en la limpieza de suelos, como mármol, terrazo, gres, mosaico, etc. Obtiene un agradable aroma a manzana verde, dejando una sensación de frescura.



HTS MARINO
Limpiador marino

Producto de amplias aplicaciones en la limpieza de suelos, como mármol, terrazo, gres, mosaico, etc. Alto poder desengrasante. Obtiene un agradable aroma a marino, dejando una sensación de frescura.



HTS AMONIC
Limpiador amoniacal

Producto de amplias aplicaciones en la limpieza de suelos, como mármol, terrazo, gres, mosaico, etc. Alto poder desengrasante. Su uso es muy recomendado en sitios y locales, donde se precise una limpieza a fondo.



HTS MARSELLA
Limpiador marsella

Producto de amplias aplicaciones en la limpieza de suelos, como mármol, terrazo, gres, mosaico, etc. Obtiene un agradable aroma a jabón de marsella, dejando una sensación de frescura.



HTS SOL
Limpiador espuma controlada

Limpiador neutro de baja espuma, para suelos resistentes al agua. Adecuado para usar con fregadora automática, así como con máquinas monodisco y sistemas de fregado manual. Neutraliza las moléculas responsables de los malos olores, intensificando el efecto del perfume y dejando una fresca fragancia.



HTS BAN
Limpiador repelente de insectos

Especialmente indicado para la limpieza diaria de suelos de todo tipo de instituciones, sin atacar el brillo en cualquier tipo de material, mármol, terrazo, gres, madera, etc. Deja una película con acción repelente para ahuyentar a todo tipo de insectos rastreros.



HTS WOOD
Limpiador jabonoso madera

Producto ideal para la limpieza de todo tipo de superficies de madera y parquet. Posee en su formulación jabones y agentes nutrientes para la madera, consiguiendo limpiar y nutrir al mismo tiempo. Respeta el aspecto original de la madera, no deja residuos y no precisa aclarado, dejando un agradable perfume.

Código	1 lt.*	5 lts**	10 lts.
HTS LIMÓN		X	X
HTS FLORAL	X	X	
HTS MANZANA		X	X
HTS MARINO	X	X	X
HTS AMONIC	X	X	
HTS MARSELLA		X	
HTS SOL		X	
HTS BAN		X	
HTS WOOD		X	

* 1 litro viene en caja de 12 unidades.

** Los 5 litros vienen en caja de 4 unidades.



Superficies



HT GLASS
Limpiacristales multiusos

Producto para la limpieza diaria que proporciona un brillo extraordinario sin velos ni marcas. Elimina la suciedad más resistente. Indicado para todo tipo de superficies, ventanas, espejos, cristales, acero inoxidable, puertas, objetos decorativos, televisores, etc.



HT MULTISS
Limpiador multiusos

Disuelve y elimina de manera rápida y eficaz suciedades en cuartos de baño, habitaciones, comedores, salas, zonas comunes y en general todo tipo de superficies que permitan ser mojadas como: cerámica, gres, mármol, grifería, azulejos, cromados, esmaltados, superficies plásticas, etc.



HTS INOX
Abrillantador de acero inoxidable

Crea un efecto antiestático y de protección frente a grasas y suciedades. Por su fácil aplicación y alto rendimiento, es idóneo en superficies de acero inoxidable (mostradores, mobiliario de colectividades, frigoríficos, etc.), así como superficies de aluminio y cromadas.

Código	750cc*	5 lts.**
HT GLASS	X	X
HTC MULTISS	X	X
HTC INOX	X	

* 750 cc viene en caja de 12 unidades.

** Los 5 litros vienen en caja de 4 unidades.



Baños



HTB 550 CALC
Detergente anticalcáreo

Esta indicado para el mantenimiento diario de baños, griferías, suelos y revestimientos en general. Con su utilización podremos evitar la acumulación de cal y la formación de incrustaciones. No altera superficies cromadas, dándoles un aspecto brillante. Su efecto limpiador junto a su agradable perfume ofrecen un elevado rendimiento higienizante.



HTB LIMP
Limpiador concentrado baños

Limpiador multiusos higienizante perfumado para la limpieza de todo tipo de superficies duras resistentes al agua, baños, suelos, paredes, oficinas, lavabos, etc. Su formulación alcalina proporciona unas intensas propiedades desengrasantes. Deja las superficies perfectamente limpias y desodorizadas con una fresca fragancia a pino que dura horas.



HTB 560 W.C.
Limpiador w.c.

Producto creado para la desincrustación y limpieza, así como reducción de olores en aseos e inodoros químicos. Producto eficaz para la eliminación del sarro y restos calcáreos. Ideal para la limpieza de, azulejos, sanitarios, baños, etc. Posee poder higienizante en su composición. No aplicar directamente sobre griferías y superficies cromadas.

Código	750cc.*	1 lts.**	5 lts.***
HTB 550 CALC	X		X
HTB LIMP			X
HTB 560 W.C.		X*	

* 750 cc. vienen en caja de 12 unidades.

** 1 litro viene en caja de 6 unidades.

*** Los 5 litros vienen en caja de 4 unidades.

* 1 litro viene en caja de 12 unidades.



Higiene y limpieza

Bolsas de basura

CÓD.	DESCRIPCIÓN	cm	Embalaje U. x rollos
45107	Bolsa comunidad G/200	115 x 135	10 x 10
45213	Bolsa industrial G/160	90 x 100	10 x 24
45415N	Bolsa industrial G/150 negro	85 x 105	10 x 25
45415	Bolsa industrial G/150 colores	85 x 105	10 x 25
144106	Bolsa doméstica G/90	52 x 58	25 x 50
144105	Bolsa doméstica G/60 eco	52 x 58	25 x 70
144111	Bolsa doméstica G/80 cierrafácil	55 x 60	20 x 40



Fregona microfibras



CÓD.	DESCRIPCIÓN	Tamaño (gr)
100701	Fregona microfibras blanca	150
100750	Fregona microfibras azul	150
100760	Fregona microfibras roja	150
100770	Fregona microfibras amarilla	150
100780	Fregona microfibras verde	150



Fregona algodón

CÓD.	DESCRIPCIÓN	Tamaño (gr)
100314	Fregona algodón extra	185
100318	Fregona algodón extra	205
100353	Fregona algodón extra	250
100313	Fregona algodón extra	275
100311	Fregona algodón extra	295



Mopas fregado



CÓD.	DESCRIPCIÓN	Tamaño (gr)
201100	Mopa algodón extra	300
201101	Mopa algodón extra	350
201103	Mopa algodón extra	400
201105	Mopa algodón extra	450
201201	Mopa sintética tiras cuadros	
201202	Mopa sintética tiras amarilla	
480400	Pinza sujeción mopa	

Carros/cubo

CÓD.	DESCRIPCIÓN	Tamaño (lts.)
409055	Carro 1 seno con prensa. Tamaño: 40 x 50 x 96 cm.	25
409056	Carro 2 senos con prensa. Tamaño: 41 x 74 x 105 cm.	25 + 25
460513	Cubo con escurridor (azul, rojo, amarillo y verde)	14



Cepillos/recogedor

CÓD.	DESCRIPCIÓN	Tamaño (cm)
460106	Cepillo fuerte	34
460107	Cepilo suave	34
460507	Recogedor	110
530214	Mango aluminio	140
530715	Mango aluminio anodizado	150



Higiene y limpieza

Gama de abrasivos, bayetas y paños



CÓD.	DESCRIPCIÓN	FORMATO
HTCL00405	Rollo estropajo fibra verde	6 m
HTCL00359	Salvauñas gigante profesional	7 x 14 cm
HTCL00314	Estropajo acero inox. (Pack 10)	40 grs.
HTCL00388	Almohadillas abrasiva inox. (Pack 6)	Pack 6

CÓD.	DESCRIPCIÓN	cm
330	Piedra pomez extra pomez	10 x 7 x 4

CÓD.	DESCRIPCIÓN	FORMATO
HTCL00875	Bayeta microfibras, varios colores	Pack 6
HTCL00512	Bayeta "multisoft" multiuso, varios colores	Pack 10
HTCL00505	Rollo amarillo "burbujas" precorta.	8 m
HTCL00536	Rollo bayeta "cruces universal"	8 m.
HTCL01497	Paño cocina superior 100% algodón	

Bayetas microfibras



CÓD.	DESCRIPCIÓN	cm
310407	Bayeta Microfibras blanco	38 x 40
31040701	Bayeta Microfibras amarillo	38 x 40
31040702	Bayeta Microfibras azul	38 x 40
31040703	Bayeta Microfibras rojo	38 x 40
31040704	Bayeta Microfibras verde	38 x 40

Bayetas microfibras extra



CÓD.	DESCRIPCIÓN	cm
310401	Bayeta Microfibras extra blanco	32 x 32
31040101	Bayeta Microfibras extra azul	32 x 32
31040102	Bayeta Microfibras extra amarillo	32 x 32
31040103	Bayeta Microfibras extra rojo	32 x 32
31040104	Bayeta Microfibras extra verde	32 x 32

Bayeta rollo



CÓD.	DESCRIPCIÓN	cm/m
310159	Rollo bayeta Universal	40 x 8
310151	Rollo bayeta multiuso	40 x 8
310158	Rollo bayeta sintética precortado*	40 x 8
310206	Rollo bayeta cristales	40 x 8

* Consultar colores

Paños



CÓD.	DESCRIPCIÓN	cm
310309	Paño cocina azul	55 x 55
310302	Paño cocina blanco	55 x 55
310111	Rejilla blanca	40 x 45

- 1 **Aldea Suministros de Hostelería S.L.** C/ Murcia, 11 Dcha, Pol. Ind. Vicolozano, 05194 - Vicolozano (Ávila)
Tel. 920 259 021 - info@aldeasuministros.com - www.aldeasuministros.com
- 2 **Bohajar S.L.** Avda. de Murcia, 105, 30836 - Puebla de Soto (Murcia)
Tel. 968 898 315 - suministros@bohajar.com - www.bohajar.com
- 3 **Comercial Sirviella S.L.** Glorieta Puente de Segovia, 3, 28011 - Madrid
Tel. 914 797 465 - sirviella@sirviella.com - www.sirviella.com
- 4 **Crisberlin S.L.** C/ Algimia de Alfara, 1 y 3, 46013 - Valencia
Tel. 963 344 962 - crisberlin@crisberlin.com - www.crisberlin.com
- 5 **Elzu Industrial S.A.** C/ Martin Etxeberria, 9-11, 20100 - Rentería (Guipúzcoa)
Tel. 943 511 237 - info@elzu.com - www.elzu.com
- 6 **Equip-Vic Girona** Avda. Gran Via Jaume I, 13, 17001 - Girona
Tel. 972 221 423 / 972 478 932 - girona@equipvic.com - www.equipvic.com
- 7 **Equip-Vic S.L.** C/ Serrallers, 8, Pol. Ind. El Verinal, 08551 - Tona (Barcelona)
Tel. 938 125 500 - info@equipvic.com - www.equipvic.com - Instagram: Espai Xef
- 8 **Ferrando Servicios Integrales S.L.** Ctra. Alcañiz, 64, 44003 - Teruel
Tel. 978 602 081 - administracion@comercialferrando.com - www.ferrandoserviciosintegrales.com
- 9 **Glassanz S.L.** C/ Constanca, 11, 28002 - Madrid
Tel. 914 135 190 - tienda@glassanz.com - info@glassanz.com - www.glassanz.com
- 10 **Hermanos López Pardo S.L.** C/ Zurbarán, 3, Pol. Ind. La Pañoleta, 29700 - Vélez-Málaga (Málaga)
Tel. 952 503 588 - ventas@lopezpardo.com - www.lopezpardo.com
- 11 **Hostelería Hogar S.L.** Travesía 16 de Agosto, 1, 48006 - Bilbao
Tel. 944 161 470 - info@hosteleriahogar.com - www.hosteleriahogar.com
- 12 **Hostelmec S.L. Fuerteventura** C/ El Diviso, 13, Pol. Ind. El Matorral, 35014 - Caleta de Fuste (Fuerteventura)
Tel. 928 163 411 - hostelmec@guerrayfernandez.es
- 13 **Hostelmec S.L. Lanzarote** C/ San Sebastián, 27, Barriada de Tenorio, 35500 - Arrecife (Lanzarote)
Tel. 928 815 127 - hostelmec@guerrayfernandez.es
- 14 **Hotelco Andorra** C/ Les Boïgues, 1, AD700 - Escaldes-Engordany (Andorra)
Tel. (+376) 720 711 - exposició@hotelco.ad - www.hotelco.ad
- 15 **Hotelco Seu d'Urgell** Carrer Major, 74, Baixos, 25700 - La Seu d'Urgell (Lleida)
Tel. (+902) 043 269 - botiga.seu@hotelco.ad
- 16 **Hoteralia Prestín** Pol. Empresarial del Prestín, 28, 33559 - Parres (Asturias)
Tel. 984 053 488 - elprestín@hoteraliacash.com
- 17 **Menaje Galicia S.L.** Rúa Otero Pedraio, 22, Bajo, 15679 - Cambre (A Coruña)
Tel. 981 667 076 - menajegalicia@menajegalicia.com - www.menajegalicia.com
- 18 **Myr Hostelería S.L.** C/ Soldado Español, 12 (Local), 40001 - Segovia
Tel. 921 442 495 - myrhosteleria@myrhosteleria.net - www.myrhosteleria.com
- 19 **Núñez Gil M.H.I. S.L.** Pilas de Panchía, 2, 14550 - Montilla (Córdoba)
Tel. 957 655 388 - comercial@nunezgil.com - www.nunezgil.com
- 20 **Promohostelería** Av. Vidal i Barraque, 32, 43002 - Tarragona
Tel. 977 91 47 48 - info@promohosteleria.es
- 21 **Suhosmar S.L.** Avda. Comuneros, 12-14, 45880 - Corral de Almaguer (Toledo)
Tel. 925 207 456 - 687 455 760 - info@suhosmar.com - www.suhosmar.com
- 22 **Suministros Hostelería Álvarez Gómez S.L.** Pol. Ind. Ombatillo, c/C s/n, 31591 - Corella (Navarra)
Tel. 948 780 859 - hosteleria@alvarez-gomez.com - www.alvarez-gomez.com
- 23 **Suministros Hostelería Llobregat S.L.** C/ Drets Humans, 13, P. Industrial Mas Alba, Naves 7 y 8, 08870 - Sitges (Barcelona) - Tel. 934 791 116
C/ Cami del Pla, 40-42, P. Industrial Mas Alba, 08870 - Sitges (Barcelona) - Tel. 931 188 967 - vimer@vimer.es - www.vimer.es
- 24 **Suministros Hostelería Vigón S.L.** C/ Eratóstenes, 52, Pol. Ind. Porceyo, 33211 - Gijón (Asturias) - Tel. (34) 985 168 459 - (34) 985 167 951
hosteleriavigon@hosteleriavigon.com - www.hosteleriavigon.com - gestion@hosteleriavigon.com - comercial@hosteleriavigon.com
- 25 **Suministros Matrio S.L.** C/ 31, 120, Pol. Ind. Catarroja, 46470 - Catarroja (Valencia)
Tel. 961 103 414 - matriox@matrio.net - www.matrio.net
- 26 **Suministros Tres Árboles S.L.** C/ Cobalto, 8, Nave 12, Pol. Ind. San Cristóbal, 47012 - Valladolid
Tel. 983 042 041 - valladolid@suministrostresarboles.com - www.suministrostresarboles.com
- 27 **Suministros Tres Árboles S.L.** C/ Muela Quebrada, 55-56 Pol. Ind. La Hiniesta, 49024 - Zamora
Tel. 980 160 076 - clientes@suministrostresarboles.com - www.suministrostresarboles.com
- 28 **Tomidoce S.L.** Polígono Industrial La Cerrajera, C/ Bodegueros, 9, 16003 - Cuenca
Tel. 969 232 704

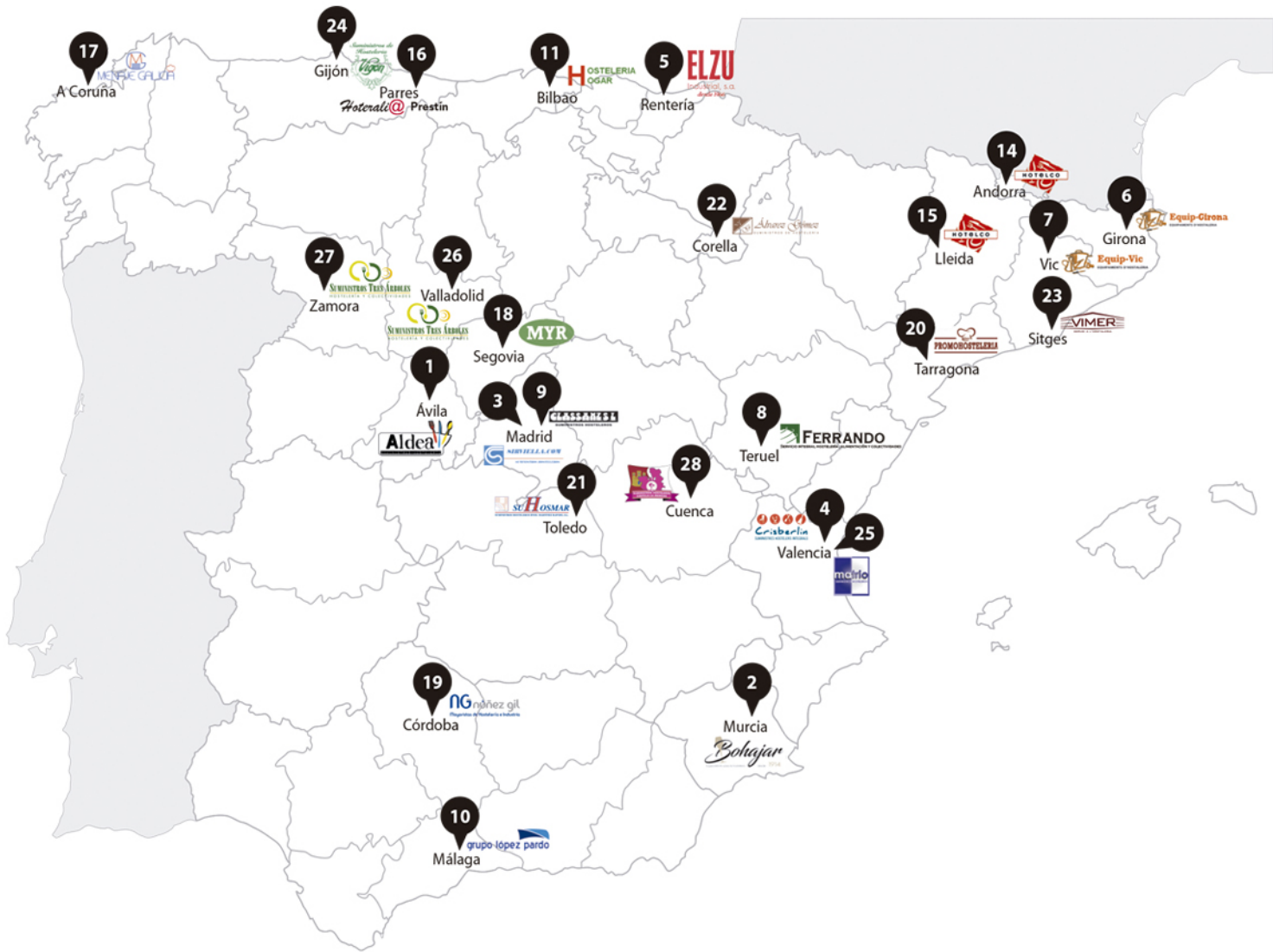

Hoterali@ GROUP



Álvarez Gómez
SUMINISTROS DE HOSTELERÍA

Pol. Ind. Ombatillo, c/C s/n, 31591- Corella (Navarra)
Tel. 948 780 859 · hosteleria@alvarez-gomez.com
www.alvarez-gomez.com



Asesoramiento personalizado para poner en marcha tu negocio. Explicanos tu idea y nosotros te ayudamos a desarrollarla.



Servicio inmediato en cualquier punto de España.

Hoterali@, la fuerza de un gran grupo y la flexibilidad de las empresas que lo componen, nos otorgan el prestigio de ser referencia nacional en el sector.



36.895 m² distribuidos en 44 almacenes en todo el ámbito nacional nos convierte en una red única en el servicio de mercancías para la hostelería y la restauración.

